



PHYSICAL MEDICINE  
IN  
GENERAL PRACTICE



Components of the solar spectrum (schematic). A symbolization of Newton's experiment

PHYSICAL MEDICINE  
IN  
GENERAL PRACTICE

---

*By*

WILLIAM BIERMAN, M D

*Attending Physical Therapist Mount Sinai Hospital  
Assistant Clinical Professor of Medicine,  
Columbia University*

With a chapter on Medical Rehabilitation by  
DR SIDNEY LIGHT

WITH 310 ILLUSTRATIONS

SECOND EDITION, REVISED AND ENLARGED



PAUL B HOEBER, INC  
MEDICAL BOOK DEPARTMENT OF HARPER & BROTHERS  
NEW YORK LONDON



PHYSICAL MEDICINE IN GENERAL PRACTICE

Copyright 1944, 1947 by PAUL B. HOEBER, INC.  
Medical Book Department of Harper & Brothers

SECOND EDITION, REVISED AND ENLARGED

1947

All rights in this book are reserved. For  
information address PAUL B. HOEBER, INC.,  
49 East 33rd Street, New York 16, N. Y.  
Printed in the United States of America

To  
BERNARD M BARUCH

*for his characteristic vision and generous  
support of the field in which his father  
was a distinguished practitioner—  
Physical Medicine*



## PREFACE TO SECOND EDITION

**T**HE SECOND WORLD WAR HAS BEEN FOUGHT AND WON since the writing of the first edition. Like the first World War, the second has been responsible for many advances in Physical Medicine. A major development is the wider recognition of the responsibilities society owes to those of its citizens who have become handicapped by disease, and as a result of injuries sustained in combat and in industry. The physical, emotional, and industrial considerations which must be reviewed and acted upon in an effort to permit the handicapped individual to regain his place as a useful member of the community as best he can is now receiving much thought. I am grateful for Dr. Sidney Licht's excellent chapter on rehabilitation covering this important aspect of postwar medicine.

Physical Medicine is now recognized as a specialty within the structure of the American Medical Association. Residencies and fellowships have been established in numerous hospitals and medical schools. The Baruch Foundation for Physical Medicine has given generous support to these undertakings. The National Foundation for Infantile Paralysis has made it possible for more technicians to be trained in recognized schools through the presentation of many scholarships.

I have endeavored to incorporate the new advances into various parts of the text, including such subjects as the combination of penicillin and fever therapy in syphilis, and early ambulation in the care of various medical and surgical conditions.

New techniques and procedures are now in the process of development within the field of Physical Medicine. These indicate that this division of Medicine will continue its progress *pari passu* with other physical and chemical advances in the healing art.

WILLIAM BIERNAN

*New York N. Y.*



## PREFACE TO FIRST EDITION

**P**HYSICAL MEDICINE" AND "PHYSICAL THERAPY" ARE synonymous terms. The former is the more modern terminology which was introduced in England and has come into common use there. Physical medicine concerns itself with the use of certain physical measures in the treatment and in the diagnosis of disease. Its therapeutic scope is large. Its diagnostic applications are limited. It is, in the main, a subdivision of the subject of general therapeutics. The line of separation between it and other sections of therapeutics often proves to be a vague and arbitrary one, for in actual practice it may be impossible to separate the chemical and psychic changes following some physical application. The various procedures in physical medicine may be grouped as thermal, mechanical, electrical, and chemical. These classifications are not exactly delimited. Thermal measures, for example, can cause mechanical, electrical, and chemical changes. Methods termed "mechanical" can produce thermal, electrical, and chemical variations. Similarly, electrical and chemical measures can be responsible for changes to which these other terms may be applied. The character of the tissues on which these agencies act will influence the nature of the response.

My objective in the writing of this book is to tell the practitioner in general and special fields of medicine how he might use physical measures with the others which he employs in his effort to be of greatest service to his patient. I have emphasized the techniques of such applications and their physiological rationale. For the sake of brevity, I have avoided, in large measure, historical references, fascinating though they be, and also extensive descriptions of the physics of light, heat, and electricity. I appreciate the validity of the analogous argument that it is not necessary to know the details of the construction of an automobile in order to be able to run it. I have felt it necessary to include reference to the physiological changes which occur following the application of physical measures, because the absence of such observations in the past has led to the practice of physical medicine on an empiric basis with the resultant rejection of large sections of this phase of therapy by the medical profession. I have attempted to emphasize those sections of physical medicine which the general practitioner may be reason-



Physical medicine has made many advances since the first World War. However, much more remains to be done to extend its use to those sick persons who can be benefited by it. This can be accomplished in many ways, including increased undergraduate and graduate medical education, its greater utilization in hospitals equipped to render this service and its introduction into those institutions at present not so equipped. With the probability of the addition of great numbers of sick and injured as a result of the second World War, and of the growing number of older people in our population, the need for this form of therapy will become even greater.

Physical medicine has its limitations. It also has the potentiality for doing harm. No agency which is capable of doing good is innocuous. Special dangers are indicated in various chapters describing the subdivisions of the subject. The chapter, "Conduct of Treatments," contains references to pit falls which should be avoided. This chapter, therefore, should serve as an introduction to the clinical application of physical medicine.

The Council on Physical Therapy of the American Medical Association has done much to develop physical medicine in this country. Educational material and information can be secured from it by addressing its secretary at the headquarters of the American Medical Association, 535 North Dearborn Street, Chicago, Illinois. There is now available a considerable English literature covering the various aspects of physical medicine. Articles on the subject appear frequently in representative medical periodicals. The special publication in the field is the Archives of Physical Therapy. This is published by the American Congress of Physical Therapy, 30 North Michigan Avenue, Chicago, Illinois.

The scope of physical medicine is very extensive, applying as it does to general medicine and to all of its specialties. No one person, no matter how large and varied his experience, can acquire first hand knowledge of all its remedial possibilities. In the effort to make this presentation as complete and as valuable as possible, I have endeavored to include the pertinent experiences of others. If I have not given due credit in each instance, it is not because I have desired to claim their findings as my own, but rather because of inadvertence or because I have wanted to avoid occupying numerous pages with long lists of references. As in other fields, much of our present knowledge is a heritage from those who have labored in years gone by. Many men devoted their lives to develop and to apply physical measures for the relief of the sick. Among others, we owe a great debt to workers in our own land—to men like Simon Baruch, J. Harvey Kellogg, and S. Weir Mitchell.

I desire to express my thanks and appreciation for the assistance given to



ably expected to apply in his practice. I have also made reference to important therapeutic considerations which are beyond the scope of the general practitioner (because of their intricacy, space requirements, cost, etc.) in order that he may become aware of them even though he cannot utilize them himself.

In order to simplify the procedure of muscle testing I have combined the muscle charts with the graphic reference to motor points as shown on the muscle and on the skin covering the muscle. This arrangement permits the examiner to visualize more clearly the motor points as he makes a record of their reactions. Separate charts arranged in this manner would facilitate the determination of electrical reactions.

Throughout the text, temperatures are usually indicated in degrees Fahrenheit because this is still the more common usage in this country in spite of the advantages of readings shown in the centigrade scale. A table of Fahrenheit-centigrade temperature equivalents is contained within the Appendix.

In an old Chinese proverb the thought is expressed that one picture is worth ten thousand words. Certain it is that in the explanation of a technique an illustration clarifies any written description. I have attempted to make these illustrations dynamic by showing the actual process of treatment rather than by depicting an apparatus by itself. I feel fortunate in securing the co-operation of so able an artist as Mr. Victor Perard.

A large number of physicians have come to employ some of the methods of physical medicine, for instance, those utilizing heating lamps, diathermy, and ultraviolet light machines. Many seem to be unaware of other divisions of this branch of medicine, both new and old, such as hydrotherapy, spa and climatotherapy, exercise, manipulation and occupational therapy. These phases of the subject offer valuable therapeutic possibilities in the treatment of many common diseases seen by the practitioner. It is unfortunate that ignorance of these possibilities on the part of members of the profession has caused many a sufferer to turn to the irregulars who have not hesitated to apply these methods even though they cannot do so with adequate appreciation of their limitations.

The field included in the subject of physical medicine is enormous, covering as it does nearly all divisions of medicine. For its proper practice, a thorough knowledge of diagnosis is necessary and also an appreciation of other methods of treatment so that the practitioner may better understand when to apply physical measures and when to withhold them because some other therapy is more effective.

# CONTENTS

PREFACE TO SECOND EDITION	vii
PREFACE TO FIRST EDITION	ix
CHAPTER	
I Heat and Cold ✓	1
II Hydrotherapy ✓	29
III Climatotherapy and Spa Therapy	67
IV Visible and Infra red Radiation	91
V Long Wave Diathermy ✓	109
VI Short Wave Diathermy ✓	138
VII Fever Therapy ✓	173
VIII Surgical Diathermy	198
IX Galvanic Current ✓	220
X Ultraviolet Radiation ✓	275
XI Massage ✓	320
XII Exercise ✓	331
XIII Occupational Therapy ✓	377
XIV Medical Rehabilitation ✓	406
XV The Conduct of Treatments ✓	430
XVI Diseases of the Locomotor System ✓	445
XVII Neurological Diseases ✓	485
XVIII Cardiovascular Diseases	518
XIX Diseases of the Digestive System	536
XX Genito urinary Diseases	551
XXI Gynecological Diseases	560
XXII Diseases of the Eye, Ear, Nose, and Throat	575
XXIII Respiratory Diseases	596
XXIV Dermatological Diseases	606
APPENDIX	617
INDEX	

me by many persons. The names of a number of these are indicated in the text. I am particularly indebted to Miss Ruth Bergmann for the material contained in the chapter on Exercise; and to Miss Rhea Kanter for the material contained in the chapter on Occupational Therapy. I want to thank Drs. Sergei Feitelberg, Sidney Licht, and A. W. Schenker for their review of parts of the manuscript; Dr. Eugene Newirth for his suggestions on spa therapy; Miss Blanche Guberski for her assistance in the preparation for illustrations on hydrotherapy, Dr. G. G. Deaver for some suggested exercises, Miss Margaret G. Fiske, for her editorial review of the manuscript, my secretary Miss Razelle Goldberg for typing it, and the members of my technical staff for their co-operation.

WILLIAM BIERMAN

*New York, N. Y.*

# CONTENTS

PREFACE TO SECOND EDITION	VII
PREFACE TO FIRST EDITION	IX
CHAPTER	
I Heat and Cold ✓	I
II Hydrotherapy ✓	29
III Climatotherapy and Spa Therapy	67
IV Visible and Infra red Radiation	91
V Long Wave Diathermy ✓	109
VI Short Wave Diathermy ✓	138
VII Fever Therapy ✓	173
VIII Surgical Diathermy	198
IX Galvanic Current ✓	220
X Ultraviolet Radiation ✓	275
XI Massage ✓	320
XII Exercise ✓	331
XIII Occupational Therapy ✓	377
XIV Medical Rehabilitation ✓	406
XV The Conduct of Treatments ✓	430
XVI Diseases of the Locomotor System ✓	445
XVII Neurological Diseases ✓	485
XVIII Cardiovascular Diseases ✓	518
XIX Diseases of the Digestive System ✓	536
XX Genito urinary Diseases ✓	551
XXI Gynecological Diseases ✓	560
XXII Diseases of the Eye, Ear, Nose, and Throat ✓	575
XXIII Respiratory Diseases ✓	596
XXIV Dermatological Diseases ✓	
APPENDIX	
INDEX	

me by many persons. The names of a number of these are indicated in the text. I am particularly indebted to Miss Ruth Bergmann for the material contained in the chapter on Exercise; and to Miss Rhea Kanter for the material contained in the chapter on Occupational Therapy. I want to thank Drs. Sergei Feitelberg, Sidney Licht, and A. W. Schenker for their review of parts of the manuscript; Dr. Eugene Newirth for his suggestions on spa therapy; Miss Blanche Guberski for her assistance in the preparation for illustrations on hydrotherapy, Dr. G. G. Deaver for some suggested exercises, Miss Margaret G. Fiske, for her editorial review of the manuscript, my secretary Miss Razelle Goldberg for typing it, and the members of my technical staff for their co-operation.

WILLIAM BIERMAN

*New York, N. Y.*

PHYSICAL MEDICINE  
IN  
GENERAL PRACTICE



## HEAT AND COLD

IN THIS CHAPTER WE SHALL DISCUSS THE PHYSIOLOGICAL alterations in the body produced by heat and cold, and also the therapeutic uses of local conductive addition and abstraction of heat by means other than the application of liquids. The latter is discussed in the chapter on Hydrotherapy. Methods of heat application by conversive energy are discussed in the chapters on Visible and Infra red Radiation, and Long and Short Wave Diathermy. Treatment by elevation of systemic temperature is discussed in the chapter on Fever Therapy. The therapeutic possibilities of lowering the systemic temperature from its normal level is now the subject of clinical investigation.

## PHYSIOLOGICAL RESPONSES TO HEAT AND COLD

The skin may be considered as the organ which lies between the interior of the body and its environment. It must, therefore, be possessed of great adaptability in order to furnish protection against mechanical, thermal, and chemical insults. It accomplishes its function by virtue of its physical and chemical composition and its physiological activities. These factors can be altered by regulatory mechanisms contained within the skin itself and within the interior of the body. The cells of the epidermis and the dermis constitute a physical barrier. The blood vessels of the skin form a large reservoir capable of holding about one quarter of the total blood volume, which increases or diminishes markedly in accordance with local and general needs. The impulses regulating changes in blood volume are transmitted through the autonomic nervous system. Changes are also brought about through the action of nerves and nerve endings, lymph channels, sebaceous and sweat glands, and by metabolic responses such as pigment formation and production of vitamin D. The skin is said to possess a specific reacting capacity for antigen more than ten times as great as the reaction capacities of muscle, brain, or plasma. These and other changes occurring in the skin are of particular importance in explaining the therapeutic value of many physical procedures whose in-





## VASOCONSTRICTORS



## VASODILATORS

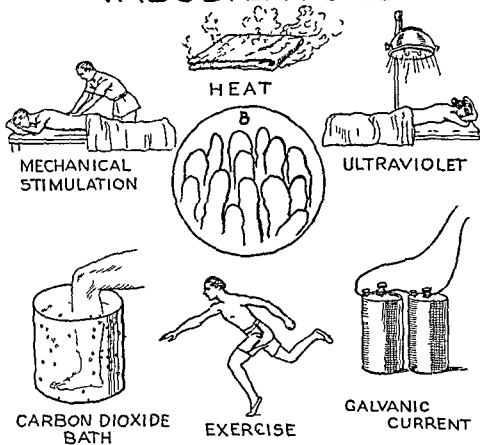

*B Dilated capillaries (Schematic)*

FIG. 1. Physical agencies causing vasoconstriction and vasodilatation. *A* Constricted capillaries

fluence is completely or mainly limited to the integument. In pharmacology, it is customary to classify drugs in accordance with their ability to cause vasoconstriction or vasodilatation. A similar classification for physical agents is outlined in Figure 1.

#### SYSTEMIC CHANGES

Ability to adapt itself to the thermal variations in its environment and to control the temperature within itself is essential to the existence of the human organism. In the healthy body, heat production is balanced against heat loss to maintain an optimum level. There is considerable variation in the temperature of different parts of the body. In many parts of the body it is below the systemic level, a fact that accounts for the ability of non-penetrating heating measures to cause an elevation in the temperature of tissue beneath the surface and beyond the range of their direct physical influence. The therapeutic effectiveness of conductive heating may be due to a physiological response of the body to avoid thermal damage to the surface. Wide variations in skin surface temperature exist, particularly in the most peripheral portions of the extremities.

In a cold environment the temperature of the tissues of the extremities falls. When exposed to excessive cold, a special mechanism comes into play—the attempt of the body to ward off local tissue damage in its most peripheral portions. The arteriovenous anastomoses in the hands and feet open, permitting the warmer arterial blood coming from the torso to be shunted through the threatened part. Thus the necessity for the blood to pass through the narrower capillary lumen is avoided. In a very warm environment the temperature level of the skin surface of the extremities rises to that of the skin surface of the torso. The entire skin surface temperature may then continue to rise. When the surrounding temperature is higher than that of the body, heat loss by conduction ceases. Further heat loss takes place through sweating with consequent evaporation of water from the body surface.

In a comfortable environment the temperature of the muscles of the extremities is lower than that of the rectum. With a normal rectal temperature of about 98.6° F., the temperature of the muscles of the calf may be 94°, or 95° F., while that of the muscles of the thigh may be 96°, 97°, or 98° F. The temperature within the veins is lower than that within the arteries in the same location in the extremities. Temperature differences also occur within the interior of the torso. The highest level, for example, is found within the liver.

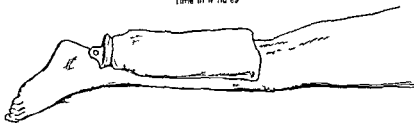
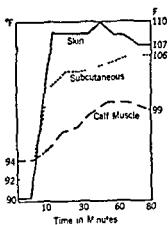

FIG 3 Temperature changes produced in the structures of the leg by application of a hot water bag

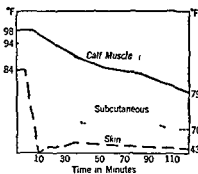

FIG 4 Changes in temperature of the structures of the leg produced by application of an ice bag

Rectal temperature, although it is used as the most accurate index of body temperature, is by no means stable; diurnal variations occur within a limit of about  $2^{\circ}$  F. The temperature tends to be higher after a meal or exertion,

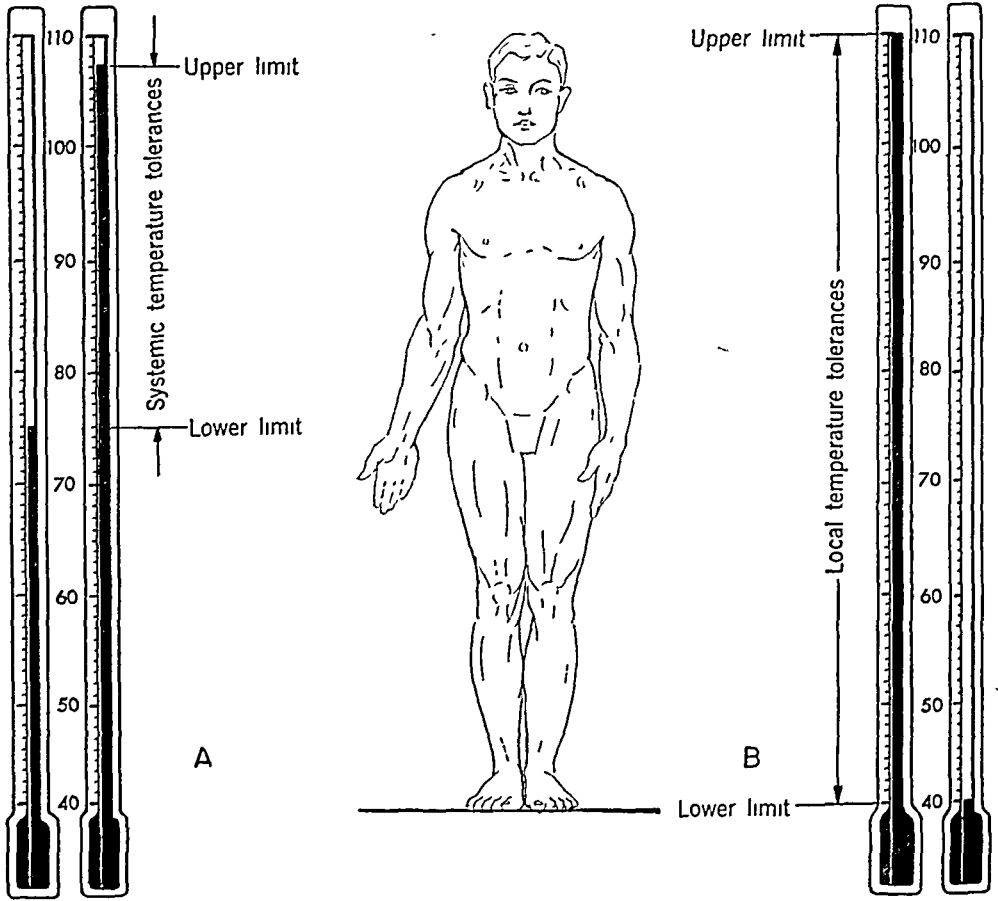

FIG 2. Temperature limits of the viable human body. Temperatures which can be tolerated for long periods of time without producing irreversible changes A Systemic B. Local. The indicated upper limit of systemic temperature is  $107^{\circ}$  F.; the lower limit  $75^{\circ}$  F. The temperature tolerances of local tissues vary between  $110^{\circ}$  and  $40^{\circ}$  F.

and lower during sleep. During severe exertion, heat loss may not be able to keep pace with heat production; and the rectal temperature may increase to  $103^{\circ}$  F. In response to bacterial invasion or to other conditions the body temperature may rise to  $105^{\circ}$  or  $106^{\circ}$  F. In a comfortable environment, the temperature may fall below its normal; I have seen it fall as low as  $92^{\circ}$  F. without apparent cause. Still greater excursions of rectal temperature can be induced by physical means. With hyperthermia artificially produced, rectal temperature has been elevated to about  $107^{\circ}$  F. and maintained there for a period of many hours. In the treatment of generalized carcinomatosis, rectal temperature has been reduced, by means of refrigeration, to about  $75^{\circ}$  F. and

Cold air blown on the calf of the leg lowered intramuscular temperature. The greatest fall observed was  $11^{\circ}\text{F}$ . This fact is of interest because it indicates the possibility of inducing thermal changes at a depth by means of cold,

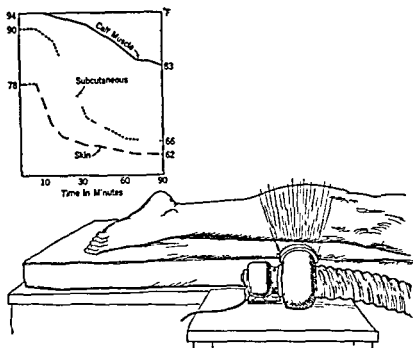

FIG 5 Changes in temperature of the structures of the leg produced by application of cold air

moving air. The common idea that drafts may have an injurious effect has this objective substantiation (Fig 5)

*Male Posterior Urethra* Experiments which I conducted with the male posterior urethra indicate that it is difficult to raise the temperature of the tissues in this region above that of the body by means of conductive heating. A hollow metal applicator was inserted into the rectum, and hot water was run through it until the limit of heat tolerance had been reached. This limit occurred at about  $110^{\circ}\text{F}$ . The subject then complained of severe cramp-like sensations. Even when the temperature of the applicator was pushed to this limit of tolerance, no elevation of temperature in the tissues was observed. In contrast, when the rectal applicator was chilled by running cold water through it, a prompt and marked fall occurred in the temperature of this region. Judging from these experiments, it would appear that it is difficult to heat conductively tissues lying within the body, but relatively easy to cool them (Fig 6)

*Female Pelvis* Conductive heating of the structures of the female pelvis by means of vaginal applicators produces but a slight rise in temperature in

held near that level for a period of a few days (Fig. 2). It has been shown that a graphic record of the morning temperatures of women will provide pertinent data concerning ovarian activity and ovulation. The oral temperature is taken daily immediately on awakening. The temperature curves so secured indicate the period in which conception is most apt to occur. The persistence of the postovulatory elevated temperature in the event of conception constitutes the most accurate early indication of a pregnancy.

#### LOCAL CHANGES

Wider variations of temperature can be tolerated by localized areas of the body than by the body as a whole. The limits which I have observed and which appear to be compatible with local tissue viability for periods of several hours, are about  $110^{\circ}$  F. and  $40^{\circ}$  F.

#### SURFACE AND DEPTH THERMAL CHANGES

*Leg.* When heat or cold is applied to some part of the body, as, for example, by means of a hot water bag or an ice bag, changes occur not only in the immediate region of the skin to which the applications have been made, but also in the structures lying beneath this region and in more remote portions of the body. Typical temperature changes produced by a hot water bag placed on the calf of the leg were as follows (Fig. 3):

Interior of hot water bag . . . . .	$133^{\circ}$ F.
Outside of towel covering hot water bag . . . . .	$122^{\circ}$ F.
Cutaneous temperature rose from $90^{\circ}$ F. to $110^{\circ}$ F.	
Subcutaneous temperature rose from $91.2^{\circ}$ F. to $105.5^{\circ}$ F.	
Intramuscular temperature rose from $94.2^{\circ}$ F. to $99.6^{\circ}$ F.	

It required about thirty minutes for the skin surface temperature to reach its maximum height; about forty minutes for the subcutaneous temperature; and about fifty minutes for the intramuscular temperature. With the application of cold, heat is transferred from the body to the colder substance. An ice bag placed on the calf of the leg caused the following temperature changes:

Interior of ice bag . . . . .	$32^{\circ}$ F.
Outside of towel covering ice bag . . . . .	$40^{\circ}$ F.
Cutaneous temperature declined from $84^{\circ}$ to $43^{\circ}$ F.	
Subcutaneous temperature declined from $94^{\circ}$ to $70^{\circ}$ F.	
Intramuscular temperature declined from $98^{\circ}$ to $79^{\circ}$ F.	

The time required for the fall in skin surface temperature was fifteen minutes; for the subcutaneous temperature, about one hour, for the intramuscular, about two hours (Fig. 4).

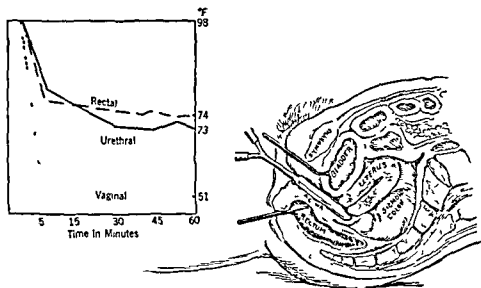

FIG 7 Changes in temperature produced by circulating cold water through a hollow metal vaginal applicator. Thermometers are inserted into urethra and rectum.

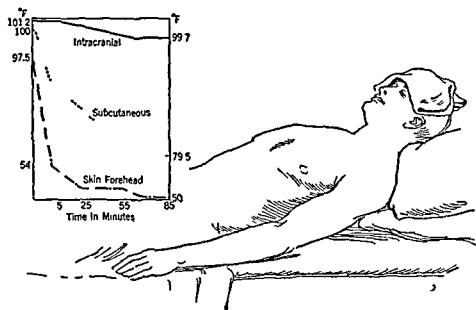

FIG 8 Temperature changes produced by application of ice bags to the head.



the tissues immediately contiguous to the vaginal applicator. Cold applied in a similar manner is followed by a very definite fall in the temperature of the structures surrounding the vagina (Fig. 7).

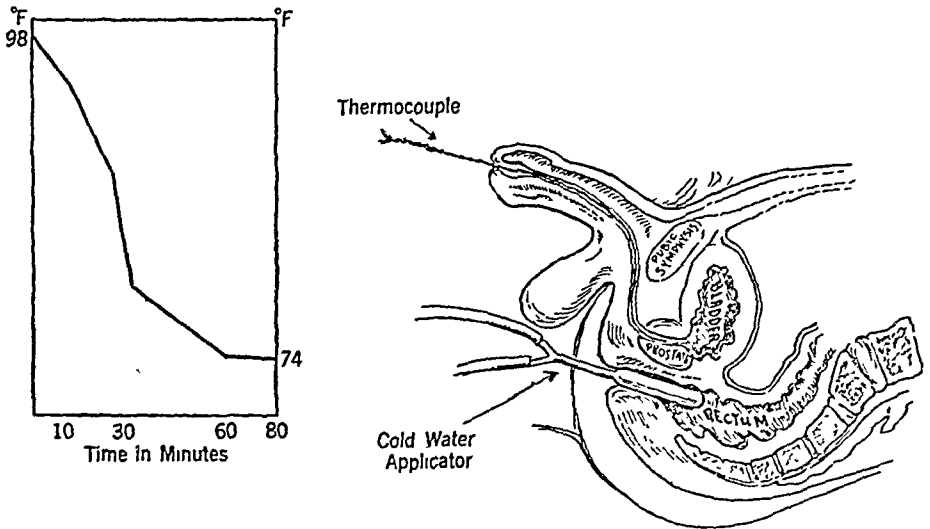

FIG. 6. Changes in temperature of the posterior urethra when cold water was circulated through a hollow metal rectal applicator. A thermocouple is inserted into posterior urethra

*Abdomen.* Neither heat nor cold applied to the human abdomen produces any marked change in the temperature within the stomach. Brill observed that in dogs hot applications placed on the abdomen did not cause appreciable change in the intraperitoneal temperature. When ingested, hot water raises the temperature of the gastric mucosa, while cold water lowers it. Bisgard and his co-workers found that heat applied to the abdominal wall of human beings inhibited motor activity of the stomach, small bowel, and colon. On the other hand, cold stimulated tonus and peristaltic activity. The drinking of hot or cold water brought reversed responses. Heat stimulated and cold had a slightly inhibiting effect on both gastric and motor activity. Cold applied to the abdominal wall and thighs markedly increased both free and total hydrochloric acid. Cold applied to the thighs produced a moderate motor response in the stomach; heat had no effect.

*Brain.* In one instance I had an opportunity to observe temperature changes occurring in the frontal region of the human brain. A thermocouple was inserted into the brain in such a position that its sensitive tip was about two inches away from the forehead. Application of ice bags to the forehead lowered the temperature of the brain  $1.5^{\circ}$  F. This observation may furnish an explanation of the benefit derived from the common practice of applying cold to the forehead (Fig. 8).

tive transfer of heat from the deep structures to the cold object placed on the surface

Application of heat produces active hyperemia which interferes with the conductive transfer of thermal energy to the tissues lying deep. The blood forms an efficient "fire screen." Bazett states that the changes occurring in the underlying tissues when heat is applied to the surface are due to the fact that venous blood returning from the surface carries heat inward. The greater the extent of vasodilation, the more rapid is this transfer. In addition, the increased arterial blood supply warms the tissues at the expense of the rest of the body. This explains the fact that tissues can be warmed to a temperature of 98.6° F with relative rapidity.

*Reflex Action* Several investigators are of the opinion that reflex reactions occur within the structures beneath the surface when heat, cold, and irritants are applied to the surface. Kuntz states "The efficiency of physical therapy in the treatment of disease depends both on the direct reflex effects of the stimulating agents employed and the influence of these agents exerted through the higher autonomic centers." The beneficial effects of localized thermal stimulation of an inflamed joint or of a localized cutaneous area of inflammation depend mainly on the reflex vasodilatation produced. The principle of counter irritation long recognized and applied in the practice of medicine is based on cutaneovisceral reflexes. Freude and Ruhmann, contrary to the findings of Bisgard, noted that application of cold to the epigastrium retarded gastric peristalsis, whereas application of heat increased it. These workers observed that localized hyperemia of the skin is accompanied by hyperemia of the corresponding viscus, and localized ischemia by ischemia of the corresponding viscus. Kuntz found that "the alleviation of visceral pain by means of any stimulating agent applied to the skin which elicits localized peripheral vasodilatation probably depends mainly upon the associated visceral hyperemia. Visceral pain, like traumatic pain, not uncommonly is associated with ischemia of the organ or tissues in question. The pain receptors involved are stimulated by a chemical substance which accumulates in the tissues because the circulation is insufficient to remove it. The functional activity of the vasomotor nerve consequently plays a major role both in the causation of visceral pain and in its alleviation."

The body maintains its thermal stability by balancing heat production against heat loss. When, for example, as a result of an increased metabolic activity, the systemic temperature tends to rise, peripheral vasodilatation occurs in order to increase heat loss. Application of heat to any part of the body to a degree sufficiently great to threaten its thermal level, is likewise

In experimental work with rabbits, Macleod and Taylor observed that following local applications of cold, temperatures in thigh, muscles, liver, kidney, and brain were substantially lowered. The temperature elevations which developed following local application of heat were comparatively slight. However, when a hot water applicator was placed against the thigh, the heat penetrated the muscles to a depth of over 20 mm. These authors concluded that the heat of a poultice or of fomentations must penetrate for a considerable distance even in relatively vascular tissues. In general, their results showed that when heating applications with a temperature of about 39° F. above that of the body were applied over approximately one quarter of the surface of the abdomen, temperature changes occurred to a depth of about 75 mm. Inasmuch as the thickness of the abdominal walls, the skull, and other tissues is much less in the rabbit than in the human being, these findings, while significant, cannot, of course, be translated directly into comparable values for man.

As a result of his investigations into the effects of cold on the body, Lake concluded: "The temperature of 43° F. must be considered critical in relationship to the effects of cold upon the tissues. Degrees of cold below this temperature produce true frost bite and actual damage to tissues. Degrees of cold above this temperature only produce effects secondarily by causing vasomotor paralysis. The use of vaso-constrictors delays the swelling in cases of true frost bite while in cases of chilling the exudation may be entirely prevented."

Lake believes that the swelling that occurs after severe local chilling is caused by loss, due to direct injury, of the tonus of the musculature of the arterioles. The resulting increased capillary pressure permits exudation of serum and fibrinogen. This increases venous pressure and frequently aggravates the condition.

#### DISTANT THERMAL CHANGES

*Conduction.* Temperature changes occurring in the tissues beneath the area to which cold is applied may result from conductive transfer of energy or from reflex change. Supporting the conductive cooling theory is the fact that the thermal gradient extending from the surface inward is gradual, and therefore a longer time is required to produce the maximum change in the deep structures than in the superficial. However, temperature changes similar to those produced by cold applications occur when the reflex arc has been interfered with, as, for example, after ganglionectomy. It would appear that vasoconstriction promptly follows local application, permitting conduc-

ence to changes occurring within the nasal cavity Mudd and his co workers found that "chilling of the body surface caused depression of the temperature of the nasal mucosa surface amounting in some instances to as much as 10° F and indicating marked reflex vasoconstriction and diminution of blood supply "

*Volume Changes* Plethysmographic studies have demonstrated that immersion of an extremity in warm water causes an increase in its blood volume and immersion in cold water a diminution in blood volume Thus, when an arm was placed in water at a temperature of 115° F., the flow of blood was 26 cc per 100 grams of tissue per minute, at 90° F., it was 13 cc per 100 grams of tissue per minute, at 79° F, it was 5.5 cc

When the quantity of blood is increased in peripheral portions of the body, it is diminished in other regions Kuntz states that in the general splanchnoperipheral interactions of the body, the tonic state of the vessels in the abdominal and pelvic organs are opposed to that of the vessels in the extraperitoneal organs and tissues Hauffe believes that the blood reservoir composed of the heart cavity, the pulmonary vessels and the aorta and its large branches balances the reservoir made up of blood vessels of the skin, the extremities, and the viscera

*Local Pressure Changes* By means of a micro injection technique, Landis was able to observe the pressure values in the arterial and the venous sides of the capillary loop When the temperature of the skin near the fingernail was raised from 89° to 107° F, the blood pressure in the arterial side of the capillary loop rose from the equivalent of 32 mm of mercury to 60 mm of mercury That in the venous side rose from 12 mm to 45 mm of mercury The intercapillary pressure value was 26 mm of mercury Landis states that the conspicuous rise of capillary pressure during heating of the skin explains the greatly increased rate of filtration and of lymph production observed in hyperemia The increase in blood pressure in both limbs of the capillary loop as contrasted with the osmotic pressure of the plasma proteins may cause edema in the part, particularly if the lymph flow is obstructed Drury and Jones showed that when such an obstruction was produced by inflating blood pressure cuffs to from 40 to 80 mm Hg, edema rapidly followed the application of heat (Fig 10)

*Systemic Pressure Changes* The reaction of the systemic blood pressure to cold has been utilized by Hines and Brown to diagnose essential hypertension Their procedure is as follows The patient lies in a recumbent position for fifteen minutes One arm is then placed in ice water at a temperature of from 39.2° to 41° F The blood pressure is taken in the other arm at the

counteracted by peripheral vasodilatation. Contrariwise, application of cold is followed by peripheral vasoconstriction in an effort to prevent heat loss. The remote peripheral vasodilatation which occurs when heat is applied to the

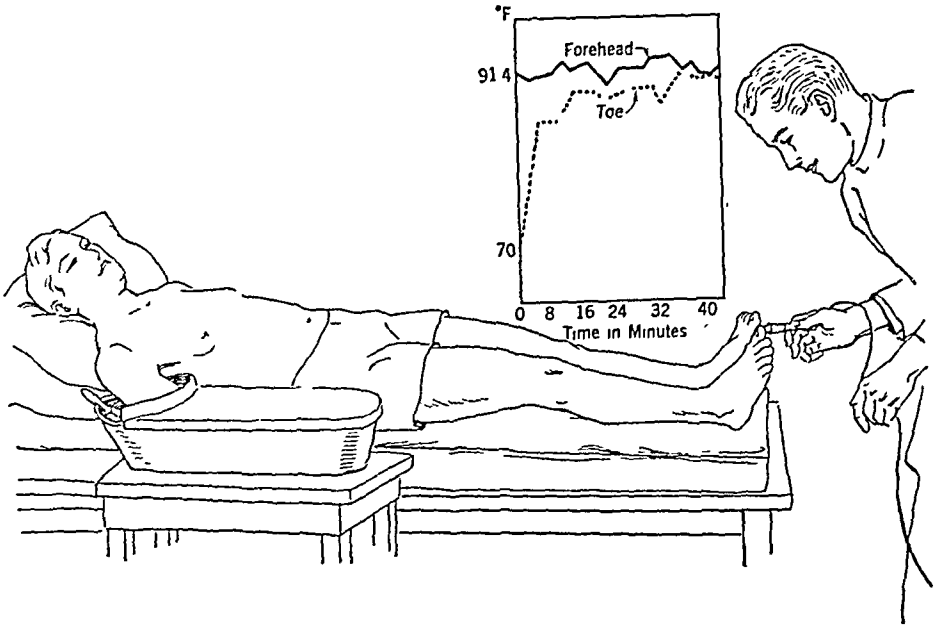

FIG. 9. Changes in temperature of the skin surfaces of the forehead and the toe when the forearm is immersed in hot water (Landis-Gibbon test).

skin surface is readily demonstrated by the Landis-Gibbon reaction (Fig. 9). In the performance of this test, the forearm is immersed in water heated to about  $110^{\circ}$  F. Usually, within ten or twelve minutes the skin surface temperature of the big toes rises to about the temperature level of the skin surface of the forehead, thus indicating general peripheral vasodilatation. Preceding this rise, slight elevation in rectal temperature can be observed. The remote temperature changes at the periphery of the lower extremities do not occur in the presence of vascular diseases such as arteriosclerosis or thromboangiitis obliterans. The Landis-Gibbon test, therefore, is of value in the diagnosis of peripheral vascular disease. For the performance of this test, any form of heating can be used; for example, ingestion of hot water or hot tea; or application of hot compresses or conversive heating energies, such as long or short wave diathermy, to the thorax, abdomen, back, or other parts of the body. It is of interest that an increase in skin surface temperature is not necessarily paralleled by a rise in temperature of the muscles of the lower extremities.

The distant effects of local cold are of particular significance with refer-

cooling power about fourteen times greater than that of air. A cold bath at  $40^{\circ}$  F increases heat production twelve times above the resting level for the first ten minutes or so. The rise in metabolism which results from a fall in the environmental temperature is effected through an increase in tone of the skeletal muscles and in some instances by fine involuntary contractions, that is, shivering and chattering of teeth.

The metabolism of tissue is increased by heat. It has been estimated, for example, that in the isolated perfused heart a rise of  $19^{\circ}$  F increased the metabolism twofold or threefold. A similar observation was made in a study of cyanosis produced in the tissues of the forearm when blood was held static by means of a constricting band around the upper arm. In a water bath at  $87.8^{\circ}$  F cyanosis became evident in three minutes, at  $107.6^{\circ}$  F, it occurred in one minute, at  $59^{\circ}$  F it was not visible until fifteen minutes had elapsed.

*Chemical Changes* The thermal changes produced in tissue by the application of heat or cold initiate a series of varying physiological effects. According to Lewis, the direct influence of heat is to increase and of cold to lessen the tone of the minute or endothelial vessels. He states "Temperature change exerts an indirect influence by altering the amount of vasodilator substances held in the tissue spaces. Heat increases and cold diminishes the concentration and thus leads to vasodilatation and to vasoconstriction, respectively. Thus, temperature directly or indirectly exerts two influences that are in conflict. Starting from normal skin temperature and passing up the temperature scale, the predominant influence is the indirect one, the vessels dilate and the skin reddens in response to the free release of metabolites, at the higher temperature such metabolites concentrate sufficiently to produce the flare, the wheal and the blister. Starting from the same point and passing down the scale, the tissue metabolites become reduced and the skin may be seen to pale a little, but as temperature falls lower, the change in metabolic activity soon becomes less in its degree and importance, and the direct or paralytic influence of cold begins to predominate, dilating the vessels and so reddening the skin. This predominance of the direct effect continues until temperatures are reached that are low enough to damage the cellular tissues, for example by solidifying them. In these circumstances, the flare, wheal and blister again appear as an indirect effect."

Lewis points out that irritants applied to the skin (electrical, chemical, thermal, or mechanical) cause the production of some histamine like substance. A triple response occurs consisting of

end of thirty seconds and again at the end of sixty seconds. The arm is then removed from the water and readings are taken every two minutes until the blood pressure returns to its original level. In normal persons there oc-

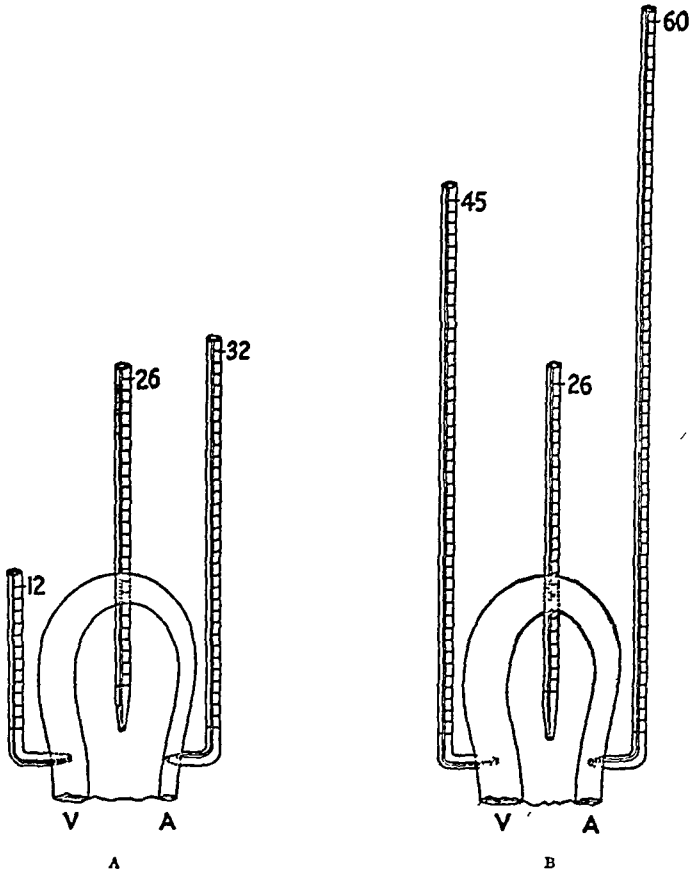

FIG. 10. Changes in capillary pressures resulting from temperature elevations A Normal pressure values (indicated in millimeters of mercury) in the arteriolar and venous limbs of a capillary loop and in the intercellular spaces B Altered values indicated in millimeters of mercury when the temperature was raised to  $107.6^{\circ}\text{F}$ . (Schematic after Landis)

curs an average rise of 8.8 mm. Hg in the systolic pressure and 7.93 in the diastolic. In patients with essential hypertension, the average systolic rise is 34.5 mm., and the average diastolic 23.2 mm.

*Metabolic Changes.* In a naked man, the metabolic rate commences to rise when the environmental temperature falls to around  $68^{\circ}\text{F}$ . The external temperature at which physical mechanisms are inadequate to maintain a constant body temperature and must be aided by increased heat production is called the critical temperature. The latter varies with the amount and the nature of the clothing. Water, owing to its high conductivity, has a

stimulants which cause vasodilatation of the painful area increases the volume of blood circulating through the tissues and reduces the concentration of the chemical substance to a level below that required to stimulate the

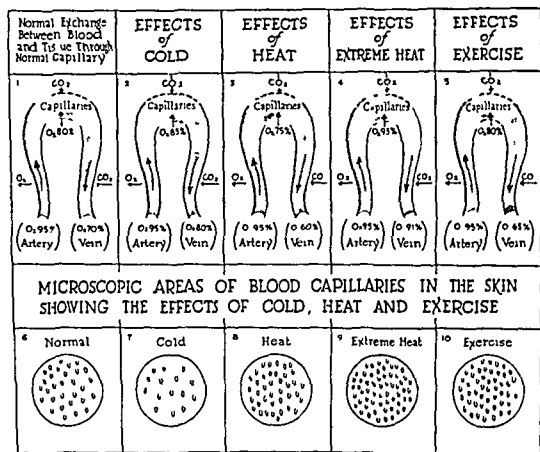

FIG 11 A study of capillaries illustrating the physiological changes in blood caused by exercise and by changes in environmental temperature (The Handbook of Physical Therapy Ed 3 Chicago American Medical Association 1939)

pain receptors In addition, local resistance of the tissues is increased and the process of repair accelerated

Kellogg summarized the chief effects of cold and heat as follows (page 18)

#### THERAPEUTIC USES OF HOT AND COLD APPLICATIONS

The process of heat production within the living human organism is continuous For this reason it is possible to produce an elevation of the temperature of the entire body or of some localized area of skin surface by interfering with heat loss An elevation of systemic temperature can, for example, be achieved by wrapping the body in several blankets As a method



1. Local vasodilatation of arteries, capillaries, and venules.
2. A flare resulting from widespread dilatation of neighboring arteries through a nervous reflex.
3. A wheal (local edema) due to increased permeability of vessel walls.

To chemical mediation is also attributed the response following stimulation of the autonomic nervous system. Kuntz says: "The chemical mediator commonly liberated by sympathetic stimulation possesses properties of adrenin and has been called sympathin; the one commonly liberated by parasympathetic stimulation possesses properties of acetylcholine and has been called parasympathin. These two divisions of the autonomic nervous system control all of the body organs. This system is interrelated with the central nervous system and the endocrine glands."

Horton has called attention to the fact that certain individuals are hypersensitive to cold. Immersion of the hand of such a person in water at 46.4° F. for six minutes will cause first pallor of the skin, then redness and swelling. Continued immersion for about three to six minutes is followed by evidence of a systemic reaction, consisting of flushing of the face, increase in pulse rate, marked fall in blood pressure, and a tendency toward, or actual, syncope. These symptoms are transitory and recovery takes place within five to ten minutes. The explanation of this phenomenon is that a histamine-like substance is produced as a result of exposure to cold in these sensitive persons. Horton advises that desensitization be accomplished by immersing the hand in water at a temperature of 50° F. for one or two minutes, twice daily, for three or four weeks.

Goldschmidt and Light showed that the chemical composition of venous blood returning from a limb depends on the balance between the metabolism and the rate of blood flow. Both these factors are increased by a rise in temperature. The changes are not parallel. At high temperatures the rate of circulation is increased so greatly that the venous blood contains large amounts of oxygen even though the metabolism is undoubtedly much increased. Bazett and Sribyatta demonstrated that when the temperature is elevated, not only is there a change in the oxygen saturation of venous blood, but physiochemical factors are also brought into play, which considerably modify gas tensions by liberating the dissociation of oxyhemoglobin and by modifying the acid base balance and the blood pH (Fig. 11).

The pain-relieving influence of heat has been explained on the basis that pain is due to some chemical substance, which possesses properties of lactic acid. In the presence of ischemia this substance may produce pain if the circulating blood fails to remove it. Local application of heat or other skin

of fever therapy, this procedure is not satisfactory because several hours must elapse before the temperature reaches a sufficiently high level. A rise in the temperature of a local skin surface area can be produced by means of a covering, such as a piece of red flannel, more popular in days gone by. The temperature of the skin surface of the body is normally below that of its interior. With local heat insulation it is possible for the temperature of the covered skin area to approach the rectal temperature.

Techniques for the application of heat and of cold to the human body are essentially the same as those employed to heat or chill inanimate objects. The responses provoked are profoundly modified by the body's physiological mechanism. These techniques may be described as conductive, convective, and conversive, and combinations of these. A hot water bottle and an electric pad are examples of objects used to apply conductive heating to the body, the heat is conducted by means of direct contact between the hotter substances and the colder ones. A person standing near a hot stove feels warm because the motion of the air between him and the stove conveys the heat to him. This is an example of heating by convection. In conversive heating, some form of energy introduced into the body becomes converted into heat. Examples are the electric currents produced by diathermy and the short wave apparatus. These methods of conversive heating will be discussed in their respective chapters.

Conductive heating has been employed universally and through the ages. It has been applied in the three forms in which matter exists, the gaseous, the solid, and the liquid, and in their combinations. The relative thermal conductivity of the skin and of the material applied, the duration of the application, and the difference in temperature between the material and the skin surface to which it is applied are the basic physical considerations. The physiological factors are the ability of the body to dissipate the heat applied (and in this the character of the circulation is the most important factor) and the thermal tolerance before discomfort and alterations of structure are produced. These factors are modified by circulatory and neural pathological changes, by the presence of inflammation, and by collections of fluid such as serum, blood, and pus.

#### AIR, HOT AND COLD

Application of heated air furnishes a method for conductive and convective elevation of temperature of the entire body or of a part of it. An example of this technique is the hot room in a Turkish bath. Here the temperature of the air varies from 110° to 200° F. While many normal persons take such

COMPARATIVE SUMMARY OF THE CHIEF EFFECTS OF COLD AND HEAT

GENERAL EFFECTS

<p><i>Primary</i> Depressant Excitant</p>	<p><i>Short</i> Excitant by tonic reaction Depressant by atonic reaction</p>	<p><i>Prolonged</i> Depressant Mixed, excitant and depressant</p>
---	--	---

SPECIAL EFFECTS

<p><b>COLD</b></p> <p><b>SKIN</b> Action.—Diminished activity Reaction:—Increased activity, diminished sensibility</p> <p><b>BLOOD VESSELS</b> Action.—Contraction Reaction —Dilation. Increased tone and activity. Local anemia, collateral hyperemia With reaction —Local hyperemia, collateral anemia Short application.—Reflex dilation of visceral vessels</p> <p><b>NERVES</b> Numbness and paralyzes. Excites by tonic reaction</p> <p><b>MUSCLES</b> Short:—Increases excitability and capacity for work Prolonged:—Lessens excitability and capacity</p> <p><b>LUNGS</b> Slows and deepens respiration Increased amount of respired air. Increased CO<sub>2</sub> Increased respiratory quotient.</p> <p><b>STOMACH</b> Increased HCl and motor activity</p> <p><b>KIDNEYS</b> Congests and excites</p> <p><b>ANIMAL HEAT</b> Short.—Increased heat production Prolonged.—Diminished heat production</p> <p><b>METABOLISM</b> Increased CO<sub>2</sub> Increased urea and improved oxidation</p>	<p><b>HEAT</b></p> <p><b>SKIN</b> Action.—Increased activity Reaction:—Diminished activity, diminished sensibility</p> <p><b>BLOOD VESSELS</b> Action.—Contraction, then dilation Reaction:—Contraction, lowered tone, paralysis. Local hyperemia, collateral hyperemia With reaction:—Local anemia, collateral hyperemia Short application:—Reflex "fluxion" and derivative effects</p> <p><b>NERVES</b> Excites. Depresses by atonic reaction</p> <p><b>MUSCLES</b> Short.—Lessens fatigue effects Prolonged:—Diminished excitability and capacity</p> <p><b>LUNGS</b> Quickens and facilitates respiration. Diminished amount of respired air. Decreased CO<sub>2</sub> Diminished respiratory quotient</p> <p><b>STOMACH</b> Decreased HCl and motor activity</p> <p><b>KIDNEYS</b> Renders anemic and lessens activity</p> <p><b>ANIMAL HEAT</b> Short:—Diminished heat production Prolonged:—Increased heat production</p> <p><b>METABOLISM</b> Decreased CO<sub>2</sub> Increased urea and general "protein waste"</p>
---	---

called Russian bath is a hot vapor bath. It is given at a temperature of about 120° F., usually for five to ten minutes, and is commonly followed by a cold plunge or a Scotch douche. When employed for so-called eliminative purposes, the duration of the bath may be ten to twenty minutes. Other indications for hot vapor baths include fibrositis, chronic rheumatic affections, obesity, chronic toxemias, peripheral neuritis, neuralgia, and sciatica. Contraindications are the same as for other energetic measures of heat application, and include organic diseases such as arteriosclerosis, heart disease, and feebleness.

#### HEATING HOODS

Applications of heated air to local areas of the body were much more commonly used before the value of convective heat from radiant lamps and the high frequency diathermy became known generally. Hoods of various shapes were designed for heating different parts of the body. The air within them was heated by alcohol lamps, gas or electricity. Bier advocated this technique as one of the triad of methods suitable for induction of hyperemia. He emphasized that in contrast with the passive venous congestion produced by the obstructive technique, heated air caused active arterial hyperemia. He found that its use in the treatment of chronic conditions after the acute inflammatory stage had passed, favored the absorption of chronic exudates, infiltrations, adhesions, and the like. He also recommended it in the treatment of neuralgic states. Acute traumatic conditions such as contusions, synovitis, fractures, tenosynovitis, and arthritis are benefited by hot air treatment. It is also advised in the care of painful conditions caused by fibrositis or swellings in the region of joints and in the treatment of gout and rheumatic states. The temperature of the air in these local hot air baths varies from about 180° to 200° F. The duration of the treatment is from fifteen to twenty minutes. The effect of this method of heating is quite different from that in which convective heating techniques are applied. As the heating occurs particularly within the skin, it may be applied in cases in which the elevation of the temperatures of the structures deep beneath the surface is contraindicated. Inflammatory states which are likely to be aggravated by convective heating may be benefited by local application of hot air.

#### COLD AIR

Cold air has been employed for both local and systemic treatment. I have noted that in patients in whom circulation of the lower extremity has been occluded by an embolus in the femoral or iliac arteries, cold air diminished

a bath because they believe it to be a healthful procedure, it has been advised for those suffering from obesity, and rheumatic and gouty states. Serious organic disability, such as generalized arteriosclerosis, cardiac disease, and hyperthyroidism, contraindicates so strenuous a method of heating.

#### CABINET BATHS

The cabinet bath is a convenient instrument for applying heat to the entire body. The heating mechanism may be placed either inside or outside the cabinet. For this purpose both electricity and illuminating gas have been used. Temperatures as high as 250° F. have been developed within such cabinets and applied to patients for periods of ten to fifteen minutes. More commonly the temperature varies from 120° to 150° F. Leaving the head outside the cabinet not only prevents inhalation of heated air but permits local application of cold to the head by means of towels wrung out of cold water or by the use of cold water circulating through coiled tubing. The most popular form of heating cabinet today is that which relies on incandescent light bulbs for its heating source. Usually forty-eight bulbs, of either the tungsten or the carbon filament variety, are used. Radiation from the tungsten filament bulbs contains a larger percentage of its energy in the visible spectrum and the near infra-red. The carbon filament bulbs contain a larger percentage of the longer infra-red radiation. Within these cabinets there occurs some degree of convective heating from the light which penetrates into and through the skin, in addition to the conductive heating of the air. Inasmuch as the temperature of the immediate environment is higher than its own, the body attempts to cool itself by means of copious perspiration. The efficiency of this method of cooling, however, diminishes as the moisture content of the air increases. The duration of a cabinet treatment usually varies from eight to twenty minutes, depending on the reaction of the patient and the disease for which he is treated.

Cabinet baths are employed as a preliminary to the Scotch douche and other forms of hydrotherapy in the care of arthritis, particularly when numerous joints are involved; gout and rheumatic affections; myositis; and myofascitis. They are also of value in the treatment of skin diseases, particularly when the lesions are widespread over the body as in chronic eczema, neurodermatitis, scleredema, and psoriasis. Cabinet baths are recommended for the relief of pain along nerve trunks, as in sciatica, brachial neuritis, and neuralgia. Their sedative effect has been utilized in the treatment of insomnia.

The heated vapor bath may be considered as intermediate in form between a bath which employs hot dry air and one which utilizes hot water. The so-

The part to which it is to be applied is washed clean and dried. If the hand is to be treated, for example, it is rapidly immersed and then withdrawn from the melted paraffin. The first contact feels hot. However, on reinsertion of the hand covered with its initial layer of paraffin, the sensation of heat is decidedly diminished. After several layers have been applied, the coating of paraffin looks like a thick glove. The hand can then be held in the melted paraffin bath or removed from it, the glove being permitted to remain in place for about one half hour, after which it can be readily removed. The hand will then be found to be very red, moist and soft, a condition suitable for massage or manipulation. For the application of melted paraffin to parts of the body such as the shoulder, elbows, knees, it is more convenient to use a brush. The initial layer is painted on quickly. It hardens rapidly. Another layer is painted on and the procedure continued until there is a thick application of paraffin. Several layers of gauze or a layer of cloth may be incorporated in the paraffin to form a more rigid dressing. The removed paraffin may be remelted and used again. Reheating for a short period is sufficient to render the mixture sterile.

Paraffin affords an excellent means of applying heat in the treatment of many conditions, including traumatic or other types of arthritis, bursitis, fibrositis, tenosynovitis, stiff joints following fractures, weakness or stiffness following nerve injuries, and scar tissue with resulting limitation of motion (Figs 12 and 13). They should be used with caution when a patient's ability to tolerate heat is interfered with, as in certain neurological and circulatory diseases. For the same reason they should not be applied to old and debilitated persons, nor should hot paraffin be placed on open surfaces.

*Mud Baths* Local hot mud baths are applied at temperatures varying from 100° to 120° F, and kept in place for periods of one half to one hour. Relatively high temperatures can be used because the specific heat of these mixtures is lower than that of water, the point of thermal indifference being about 120° F in contrast with that of water, which is about 93° F. In addition to its heat, the mechanical pressure of the mud may have a beneficial effect.

Indications for hot mud baths are chronic inflammation of joints and surrounding tissues (an active inflammatory process is a contraindication), fibrositis, sciatica, brachial neuritis and neuralgia, sprains of joints and muscles, and chronic rheumatism. The unfavorable reactions that sometimes result from these applications are explained by the fact that there is a resorption of substances which act like foreign proteins. Symptoms of depression, insomnia, elevation of temperature, and local pain may occur. These

pain and retarded development of gangrene. The technique which we have employed is to circulate air at a temperature of about 40° F. through a box placed over the leg.

The heat-removing ability of circulating air has a role in cases in which physically induced elevations of systemic temperature are used. An electric fan played over the head and face makes these treatments much more comfortable.

Temple Fay has treated patients suffering from general carcinomatosis by lowering the systemic temperature through the use of ice packs and of an air-conditioned room, the temperature of which is maintained at about 60° F. The results achieved by such lowering of temperature are still to be evaluated. It has been stated that the pain experienced by these patients was temporarily diminished. It has also been reported that tumor masses regressed with continued application of local cooling produced by applicators containing circulating cold water. Other conditions reported to have been benefited by general hypothermia include morphine addiction, leukemia, and schizophrenia.

#### SOLID SUBSTANCES, HOT AND COLD

Various solid and semi-solid substances have been employed for local and general application of heat. The specific heat of these substances is lower than that of water, and therefore they may be administered at a temperature higher than that of water. Although in Europe, extensive use has been made of various muds, in this country the paraffin bath is preferred, because paraffin is cleaner, easier to apply, and more readily obtainable. It is possible that the muds found in different parts of the world have special properties other than heat, but from the point of view of heating alone, paraffin has the advantages mentioned.

*Paraffin Baths.* The ordinary commercial paraffin obtainable in grocery stores and employed extensively by housewives for covering jelly jars is suitable for therapeutic paraffin baths. This is melted in a double boiler (a one and one-half quart size is convenient for most purposes). To avoid the danger of applying melted paraffin when it is too hot, its temperature should be tested by thermometer readings; or, more simply, it may be allowed to cool until the surface begins to congeal. At this point, the temperature of the paraffin is about 125° to 130° F. The temperature of the paraffin bath may be lowered by mixing mineral oil with the solid paraffin in the ratio of one part of mineral oil to four parts of paraffin. The melting point of the mixture is lower than that of the solid paraffin.

should be allowed to subside before another application is made Kowarschik incorporates powdered red pepper (paprika) in the mud to increase the counterirritant properties of the mud

*Hot Water Bags, Hot Salt Bags, and Hot Sand Bags* The effective heat obtained from hot water, hot salt or hot sand bags is derived from the material forming the cover of these bags The heat of the cover is, in turn, influenced by the heat of the material within the bag The source of this heat may be substances entering into chemical reactions initiated by the addition of water or from without Chemically heated bags are available in special forms as sinus pads, eye pads, and so forth The material applied to the treated part may be heated by water, as in a hot water bag The water is renewed after it cools, or its heat can be maintained by the use of a small electric heater immersed in it

A special type of hot water bag designed for use in body cavities is heated by circulating water The water is held at a given temperature (usually about 125° F) by a heater and thermostat A pump circulates it through the apparatus and applicator, and maintains a pressure of about 2 pounds per square inch This pressure distends the collapsible rubber bag which acts as the applicator and so permits it to make good contact with the treated surface An apparatus of this type is the "Elliot" The therapeutic possibilities and limitations of this machine are those of conductive heating produced by a hot solid substance—rubber Conductive heating created in this or any other manner is not as penetrative as convective heating by means of high frequency currents (long or short wave diathermy) This fact does not negate its value as a therapeutic agent On the contrary, it may be of greater service because of its heating limitations For example, this apparatus may be valuable in the local treatment of pelvic inflammatory disease, acute or chronic, specific or non specific, for which more penetrative heat may be contra indicated An apparatus has been constructed to inflate collapsible rubber vaginal applicators with heated air

*Electric Heating Devices* Solid substances can be heated directly by the electric current, as in the electric heating pad, electric blanket, and metallic applicators Electric pads are usually made to furnish three grades of heat—low, medium, and high In using these pads the danger of burns must be guarded against Electric blankets which are designed to avoid overheating, can be used in the treatment of shock and to maintain body temperature levels postoperatively

*Cooling Devices* Local applications of cold can be made by the use of ice, solid objects such as coils and applicators through which cold water or other





FIG. 12. Paraffin bath Hand removed after dipping in melted paraffin contained within double boiler

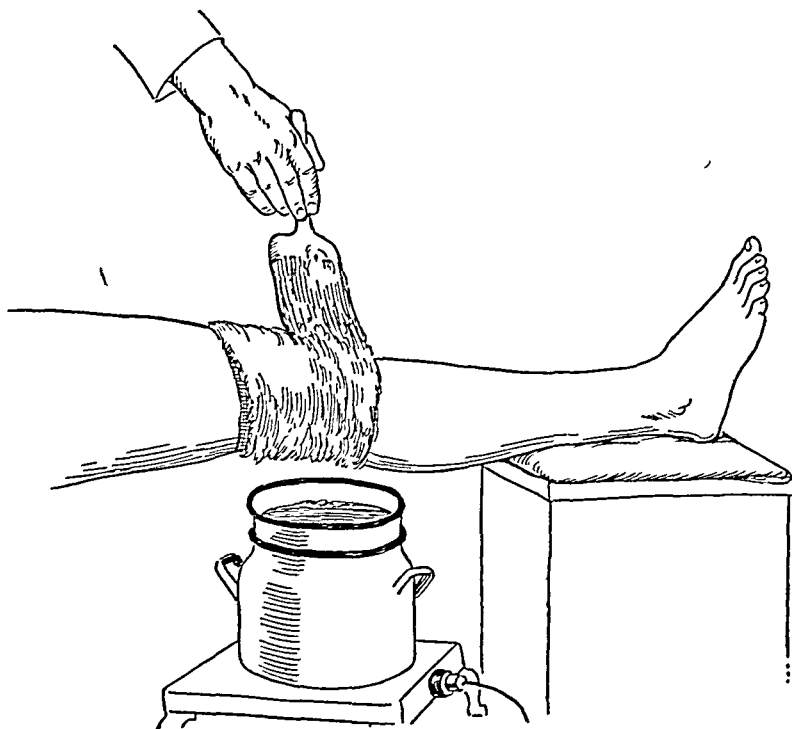

FIG. 13. Painting over region of knee with melted paraffin, into which gauze has been incorporated.

cold causes tissue damage. Within the indicated thermal limitations, irreversible change is usually not produced. Unusual intolerance of tissues is found in certain states, namely, when circulation is impeded, where extravasation of blood and body fluids occur, when there is a loss of thermal sensation or extreme sensitivity, or where an allergic reaction occurs to these physical agencies. Heating energies adequate to produce elevation of systemic temperature should be applied with extreme care, if at all, in the presence of severe organic diseases. In acute inflammatory conditions cold rather than heat may be indicated. Prolonged applications of cold may diminish the capacity of tissues to react and thus hinder repair. This is particularly important when skin has become atrophic, as for instance, following the production of radiodermatitis.

## REFERENCES

- BAZETT, H. C. The physiological basis for the use of heat. In *Principles and Practice of Physical Therapy* Hagerstown, Maryland, Prior, 1932, Vol. I, Chap. 4.
- BAZETT, H. C., and SRIBYATTA, L. Effect of local changes in temperature on gas tensions in the tissues. *Am J Physiol*, 86: 565, 1928.
- BISGARD, J. D., MATSON, G. M., and HIRSCHMANN, J. Adynamic ileus and thermal influences on gastric and intestinal motor activity. *JAMA*, 118: 447, 1942.
- BRILL, S. Effect of abdominal thermal applications on the intraperitoneal temperature. *Ann Surg*, 89: 857, 1929.
- DAVIS, M. E. Oral basal temperatures. *JAMA*, 130: 929, 1946.
- DRURY, A. N., and JONES, N. W. Observations upon the rate at which edema forms when the veins of the human limb are congested. *Heart*, 14: 55, 1927.
- FAY, T. Observations on prolonged human refrigeration. *New York State J Med*, 40: 1351-1354.
- FREUDE, E., and RUHMANN, W. Das thermoreflektorische Verhalten von tonus und kinetic am Magen. *Ztschr f d ges exp Med*, 52: 338, 1926.
- GIBBON, H. J., and LANDIS, E. M. *J Clin Investigation* 11: 1019, 1932.
- GOLDSCHMIDT, S., and LIGHT, A. B. The effect of local temperature upon the peripheral circulation and metabolism of tissues as revealed by the gaseous contents of venous blood. *Am J Physiol*, 93: 146, 1925.
- HAUFFE, A. G. Die physikalische Therapie des praktischen Arztes. *Med Klin* vols. 21 and 22, 1926.
- HINES, E. A., and BROWN, G. E. A standard test for measuring the variability of blood pressure, its significance as an index of the prehypertensive state. *Ann Int Med* 7: 209-217, 1933.
- KELLOGG, J. H. *Rational Hydrotherapy*. Philadelphia, Davis, 1901.
- KUNTZ, A. Relation of autonomic nervous system to physical therapy. *Arch Phys Therapy* 19: 24-29, 1938.

cooling liquids or gases are caused to circulate; cold air, stationary or in motion; and cold water. Compresses kept cold by means of ice are employed in the treatment of headache and acute inflammatory states such as bursitis, contusions, sprains. In the latter conditions cold applications are usually not indicated for periods longer than twenty-four to forty-eight hours. The vasoconstriction thus produced serves to retard and diminish further extravasations of blood and lymph with consequent reduction of swelling. Maintained too long, however, cold retards healing.

The metabolism and circulation of an extremity can be diminished by cold air, ice bags, or cracked ice. Use is made of this fact in the care of a leg, for example, in which the circulation is shut off by an embolus, and the patient's general condition precludes the possibility of operative intervention. The cold air appears to relieve pain more effectively than does morphine. Preceding amputation, cracked ice placed around the extremity anesthetizes and dehematizes the operative field.

*Solid Carbon Dioxide.* Dermatologists use solid carbon dioxide for the treatment of nevi, warts, and telangiectasis. This substance may be obtained from carbon dioxide cylinders or purchased as "dry ice" in confectionery stores. Its temperature is in the neighborhood of minus 174° F. Depending on the length of time during which it is permitted to remain in contact and the pressure at which it is applied, it is possible to produce skin changes varying from erythema to deep ulcerations. One to two seconds with light pressure suffices to produce an erythema; fifteen to forty seconds with strong pressure may be necessary to produce deep ulcerations. A mixture which has been advised for the removal of blemishes, particularly those produced in severe cases of acne, consists of pulverized carbon dioxide, acetone, and precipitated sulphur, placed in a gauze bag and held in contact with the skin. The cold produced by spraying ethyl chloride is employed for local anesthesia.

#### LIQUIDS, HOT, COLD AND NEUTRAL

Water is the most important fluid medium for therapeutic application of heat and cold. It is administered with and without chemicals. The description of its uses and methods of application are discussed in the chapter on Hydrotherapy. Other liquids used therapeutically are alcohol and oils.

#### CONTRAINDICATIONS TO THE USE OF HEAT AND COLD

Specific conditions which require that heat or cold be applied cautiously, if at all, are indicated in many sections of this book. Intense heat or intense

## CHAPTER II

# HYDROTHERAPY

### PHYSIOLOGY

THE EXTERNAL USE OF WATER IN THE TREATMENT OF disease is termed "hydrotherapy." Water is an excellent medium for conductive heating or cooling of the human body, because it readily absorbs or gives off heat. Inasmuch as its major constituent is water, the body is supplied with an excellent natural medium for heating and cooling. The physiological changes produced by the application of heat and of cold are discussed in Chapter I. The greater ability of water to absorb heat accounts for the fact that while air at 80° F. is a comfortable medium for the human body, water at the same temperature evokes a sensation of cold. Whether an application of water causes a sensation of warmth or of cold depends on the temperature of the water and also on the temperature of the skin to which the application is made. Other factors also play a part in the recognition of thermal sensation in different parts of the body, for instance, the character of the local circulation, the existence of numerous arteriovenous anastomoses, the number of thermal nerve ends. In general, 93° F. is the point that represents the dividing line between the sensation of warmth and of cold because this is the temperature of the major portion of the body's skin surface. Therefore, baths below 93° F. feel cool, those at higher temperatures feel warm. Due to the variations in skin temperatures and in other factors, water at a given temperature may feel either warm or cold to different individuals and to the same individual at different times and on different parts of his body. "Hot" and "cold" are therefore relative terms. However, the following may be considered a general classification for water baths:

	<i>Degrees Fahrenheit</i>
Very cold	Below 55
Cold	55-65
Cool	65-80
Tepid	80-93

LAKE, N. C. An investigation into the effect of cold upon the body. *Lancet*, 2 : 557, 1917.

LANDIS, E. M. Micro-injection studies of capillary blood pressure in human skin. *Heart*, 15 : 209, 1930.

LEWIS, SIR THOMAS. *Blood Vessels of the Human Skin*. London, Shaw and Sons, 1927.

MACLEOD, J. J. R., and TAYLOR, N. B. Effects of hot and cold applications to the surface of the body on temperature of muscles, liver, kidney, and brain. *Lancet*, 2 : 70, 1921.

MUDD, S, GOLDMAN, A., and GRANT, S. B. Reactions of the nasal cavity and postnasal spaces to chilling of the body surface. *J. Exper. Med.*, 34 : 11-45, 1921.

be explained by the production of the histamine like substance described by Lewis. To a substance of this type has also been ascribed the immediate secondary reactions which may occur following hydrotherapeutic applications. Delayed secondary responses, according to Ray, usually begin a few days after the treatment has started. He compares these to reactions produced by the injection of autogenous blood.

To prevent too vigorous a reaction following the application of cold water, friction may be employed during the application, except in the case of the wet pack, which should not be used for feeble patients. Baruch suggests that the temperature of the water be diminished one degree with each succeeding treatment. The temperature should not be reduced during a treatment.

#### FULL IMMERSION BATHS

One of the simplest forms of hydrotherapy, available in nearly every home because of the ubiquity of the bathtub, is the immersion bath. Depending on the temperature of the water, these baths are called neutral or cold, cool, subthermal, tepid, and hot.

#### NEUTRAL BATHS

Because the temperature of the major part of the body's surface is about 93° F, water at a similar temperature produces comparatively little change in the body's physiology. Likewise, a variation of a few degrees either below or above this temperature exerts but little influence on the body's activity. The range of relative thermal indifference lies between about 90° and 97° F, within this range the production and loss of heat is relatively small, and there is no definite impression of heat or of cold. For this reason a bath at these temperatures is particularly suitable for cleansing purposes, and also for underwater exercise. Because they also exert a sedative effect, they are used in the treatment of anxiety, psychasthenia, insomnia, and the violence of mental derangement. Their duration may be fifteen minutes to an hour or longer.

#### CONTINUOUS BATHS

When the water is permitted to flow continuously in and out of the tub, the bath is referred to as a "continuous bath." For prolonged immersion it is convenient to place the patient in a hammock suspended within the bathtub. A thermostat will keep the water at a constant temperature, but its accuracy should be checked at frequent intervals with a reliable bath thermometer.

	<i>Degrees Fahrenheit</i>
Warm or neutral . . . . .	Below 93-98
Hot . . . . .	98-105
Very hot . . . . .	105-115

Application of cold water for a short period of time produces the so-called "hydrotherapeutic reaction." The nature of this reaction depends on the individual, on the duration of the application, the temperature of the water, the size of the area treated, and the manner in which the water is applied. Cold applied for a short period of time to a large part of the skin surface in healthy individuals causes shivering, "goose flesh," constriction of superficial blood vessels, and increased pulse and respiratory rates, followed by a sensation of warmth, and dilatation of blood vessels with an increase in muscle tone and metabolism. It is a tonic, stimulating reaction. A brief systemic application of hot water has an initial stimulating effect which is followed by muscular relaxation and diminished metabolism. This response has been called "atonic." It may cause undesirable changes in very young persons, and in the very old, particularly when marked vascular changes are present. Individuals of the so-called rheumatic or tuberculous type are best given brief baths with but slight temperature variations.

The reaction to cold may be good after a short exposure but markedly worsened by prolonged application. A good reaction is more likely to occur in a patient whose skin has been previously warmed by friction, vigorous exercise, preliminary hot bath, or other warming measures. Baruch has classified the reactions to cold baths as follows:

**Poor:** If in addition to a feeling of chilliness, there be chattering of the teeth, rigor and cyanosis. In this condition, it may not be necessary to abandon the treatment, but to use a much briefer time of application and also to add friction.

**Defective:** If patient feels chilly twenty to thirty minutes after the treatment. It is then best to diminish the size of the area to which the treatment is applied and also its duration.

**Fair:** If the patient does not feel uncomfortable one-half hour after the treatment.

**Good:** If the patient feels exhilarated.

**Excellent:** If the patient feels exhilarated and the skin becomes pink during or after the treatment.

The reaction produced forms the basis for determining the type of hydrotherapeutic measures to be used in a given case. According to Baruch, "mild thermic applications stimulate, more intensive applications enhance the stimulating effect, but too intense applications depress." These changes may

formed The indications for underwater exercise, as mentioned by Lowman, include spastic paralysis, poliomyelitis, mobilization in the after-care of plastic and joint operations and tendon transplantations, chronic arthritis,

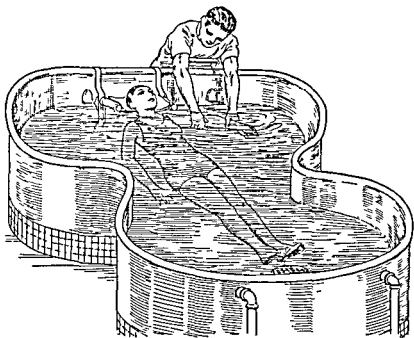

FIG 14 Exercise under water in special tank

painful backs, muscular in-co ordination, some neurological conditions, and conditions which require metabolic and psychological stimulation Lowman states that underwater exercise should not be employed in the presence of acute joint inflammations or other acute infections, febrile diseases, acute neuritis, active pulmonary tuberculosis, and acute stages of poliomyelitis

#### HOT BATHS

An immersion bath with the water temperatures ranging between 96° and 105° F feels decidedly hot At such temperatures loss of heat from the body's surface is stopped, except from the protruding head At the same time, the body is heated by conduction and therefore the temperature of the entire body will rise The immersion bath is a rapid means of producing artificial fever Its efficiency is so great that it may prove a dangerous method for the maintenance of prolonged temperature elevation Short periods of immersion may cause comparatively little dislocation of the temperature level Baths lasting two to fifteen minutes are employed in the treatment of chronic rheumatic manifestations in joints, fibrous tissue and muscles, for the relief of muscle spasm, and of colic in the gastric, intestinal, gall bladder,



The patient's temperature should also be observed closely. A rubber pillow should be so placed that the head is held out of the water. To prevent maceration some greasy substance should be applied to the skin, inasmuch as the patient may remain immersed for twelve or more hours. This type of bath is valuable in the treatment of psychoses, skin diseases, extensive burns and ulcerations, and in chronic inflammations of muscles and joints. It should be avoided in the presence of dermatitis, which is aggravated by it; and in asthenic, debilitated, and hypotensive states.

#### EXERCISE IN WATER

Immersion of the body in a bath permits freer motion of the extremities. According to Archimedes' principle, the body is buoyed up by a force equal to the weight of the liquid displaced. The ordinary bathtub is not large enough for the satisfactory performance of all forms of therapeutic exercise. A pool of sufficient size to permit of walking in water and of swimming is ideal for the purpose. However, the expense involved in the construction and maintenance of swimming pools is too great to permit their use except in large, subsidized institutions. Tanks sufficiently wide to permit abduction of the extremities as the patient lies within them have proved to be a satisfactory substitute in most instances (Fig. 14). The center portion is indented to allow the attendant to approach the patient. A canvas shelf holds the patient's head out of the water. We have found that a portable back-rest which can be moved to any part of the outer edge of the tank serves to prevent back strain in the technician. So does placing the tank at a proper height from the floor. Another tank that has been advised as a practical substitute for the more expensive, especially constructed tanks is a large, round, galvanized tank of the type used for watering cattle. Such a tank is much cheaper, but it is not as satisfactory as those built for the purpose. Specifications for the construction of a special tank can be secured from the Council on Physical Therapy of the American Medical Association.

The transfer of patients into a tank may, at times, be a problem. A stretcher connected to an overhead pulley may be required for patients unable to co-operate in their transfer. For the more co-operative patients, we have found a tall, revolving stool to be of value. After the patient has seated himself on the stool (with the assistance of a short step which is attached to it), the attendant elevates his legs and rotates the stool. The legs are lowered after they have been swung around over the edge of the tank.

The temperature of the water in the tank should be held within the neutral range. The duration of the immersion depends on the exercise to be per-

## CHEMICAL BATHS

## NATURAL AND ARTIFICIAL "NAUHEIM BATHS"

The immersion bath can be modified by mixing various gases and solid substances with the water. Such mixtures sometimes occur naturally and furnish the *raison d'être* for spas throughout the world. Waters containing large amounts of carbon dioxide are found in certain places, for instance, at Nauheim and at Saratoga Springs. Effervescing carbon dioxide baths may be made artificially by means of a special carbon dioxide mixing apparatus, by permitting carbon dioxide gas to flow from a cylinder through perforated tubes placed in the bottom of the tub, or by adding chemicals in the water. None of these baths is as effective therapeutically as natural carbon dioxide water. The first process is expensive and requires cumbersome installations, the second produces relatively large bubbles which are comparatively ineffective, the third is simple and can be used in the hospital or the home. To make the latter type of bath 4 to 8 pounds of salt are placed in a tub containing about 40 gallons of water. One-half pound of sodium bicarbonate is added, then six to eight large tablets of acid sodium sulphate are placed at equal intervals on a rubber sheet at the bottom of the tub (The purpose of the sheet is to prevent corrosive action on the bathtub.) Another technique for making an artificial carbon dioxide bath by the addition of hydrochloric acid to a solution of bicarbonate of soda is described by Harpuder. The value of artificial carbon dioxide baths is considered to be less than that of the natural baths because the bubbles of gas are larger, they are locally more irritating because the gas escapes more readily from the water and the percentage of the gas in the water is much less (Figs 15 and 16).

The special beneficial action of these baths is attributed to the bubbles of carbon dioxide gas which are liberated in great quantities. The patient should lie quietly in the bath, without unnecessary motion, to avoid dissipating the layer of bubbles next to his skin.

The carbon dioxide bath can be administered at a lower temperature than can the ordinary bath. This is due to the stimulation of the thermal nerve ends and to the heat insulating quality of the layer of gas bubbles. The Nauheim procedure begins with a saline half bath at about 95° F and lasting for five to eight minutes. The subject then rests for a period of two hours. Baths are administered every other day, with progressively increasing percentages of carbon dioxide. At the start 25 per cent is used, this is increased

or urinary tracts. Currence is enthusiastic about the results obtained by hot water baths in patients suffering from chronic arthritis. He recommends that the patient be placed in a tank with the water at about body temperature. After immersion the temperature is increased to the point at which it produces maximum muscle relaxation (about 101–104° F.); it is then gradually lowered to the level found most comfortable for the patient (between 96–98° F.). Massage should be applied while the patient is in the tank; first, gentle stroking, then kneading. Motion should also be encouraged; at first passive, then active, and later, resistive. Because of its severity, this type of bath should not be administered to patients with severe organic diseases, such as those involving the heart and arteries or the central nervous system.

#### COOL BATHS

A cool or tepid bath at a temperature between 70° and 90° F. was used in years past for its antipyretic effect in cases of fever. When a patient was immersed in this bath for about thirty minutes, his pulse became slower and his temperature lower. Nowadays with better appreciation of the fact that fever is nature's way of enhancing the body's immunological powers, such antipyretic measures are not adopted unless the body loses control of its heat-regulatory mechanism, as is the case in heat stroke. In the care of this condition, it is better to cool the body by means of an electric fan (which causes evaporation of water on the skin) or by wrapping the patient in a sheet moistened with tepid water.

#### COLD BATHS

A cold immersion bath whose temperature varies from 50° to 70° F. may be used, but for very short periods of time (four seconds to three minutes) during which the body should be briskly rubbed by the patient himself or by an attendant. After the bath, the patient should be briskly rubbed with a towel and dried quickly. Because of the vigorous reaction which it produces, this bath should be given only to robust individuals. In such persons it causes a feeling of general exhilaration; the circulation becomes more rapid and the appetite is stimulated. If chills and cyanosis develop, the patient should be promptly removed from the bath.

The cold bath is used as a metabolic stimulant, for the treatment of debility due to a sedentary existence, for obesity, and for atonic states. It should not be administered to very young or very old persons, or to those who are feeble because of the presense of some organic pathological change.

or functional heart conditions, the baths are first administered for five minutes at 93° F, thereafter the temperature is reduced at each bath until a level of 85° F is reached. The best time for taking these baths is in the



FIG 16 Artificial carbon dioxide bath. The hydrochloric acid is being siphoned into the tub. This action is started by the attendant who has blown through the short unconnected glass tube which passes through the bottle cork. One hundred cubic centimeters of commercial hydrochloric acid has been diluted with about two parts of water. The total volume of 300 cc of diluted acid is added slowly and carried to the bottom through the weighted end of the rubber tubing. The attendant moves this tubing along the bottom of the tub. He controls the rate of flow of the acid by constricting the tube. The concentration of the ingredients may be increased if a stronger effect is desired. The temperature of the bath is a neutral one, varying from 90 to 98 F. The duration is from ten to thirty minutes. (After Harpuder)

morning, two hours after a light breakfast. It is important that they be followed by a rest period of two hours, otherwise, much of the beneficial influence is lost.

The carbon dioxide in the bath enters the body through the skin. The skin becomes red, indicating increased circulation not resulting from temperature influence. Corresponding diminution takes place in the circulation of the deeper organs. The heart is slowed, possibly by reflex excitation of the vagus nerve. According to Groedel, the carbon dioxide bath has an action similar to digitalis on the blood pressure, if high, the blood pressure is lowered, if low, it is raised. Respiratory and pulse rates are slowed. There is increased elimination of urine. Hediger states that the cardiac muscle becomes trained without increasing the frequency of the heart beat.

to 50, 75, and 100 per cent. If dyspnea is relieved, the temperature of the baths is reduced to as low as 86° F.

The number and frequency of baths are arranged in accordance with the

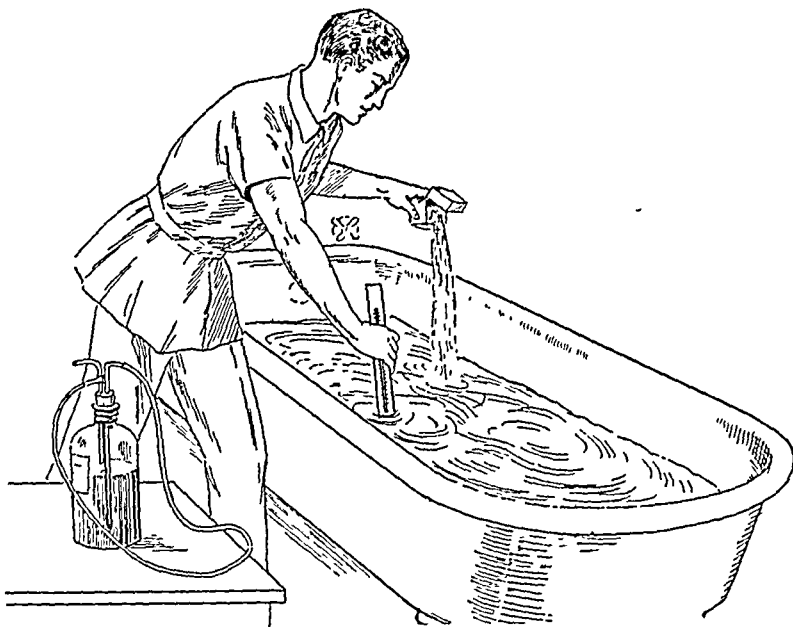

FIG 15. Artificial carbon dioxide bath. A porcelain or wooden tub is suitable. The metallic rim and plug of the outlet of the porcelain tub is covered with a small rubber mat to prevent corrosion. The attendant pours bicarbonate of soda into the water while he stirs it with a stick which holds a thermometer. Eighty-four grams of sodium bicarbonate dissolved in water and mixed with 37 gm. of hydrochloric acid will deliver 44 gm. of carbonic acid. There should be no surplus of acid. Therefore, the baking soda is dissolved at the rate of  $\frac{1}{4}$  pound for each 5 gallons of water. The patient is immersed in the solution after the alkali has been dissolved and before the acid is added. (After Harpuder.)

results achieved. When the cardiac insufficiency is relatively recent or the compensation is good, full-strength saline and carbon dioxide baths are administered in a series of three. The temperature of the first bath is held at 95° F. Subsequent bath temperatures are reduced, 80° F. being the lower limit. The duration of the baths is increased up to a period of twelve minutes. If there is no disturbance of compensation, the first baths may be a combination of carbon dioxide and saline in their strongest concentration, at a temperature of 90° F., for a period of ten minutes. The time may be gradually extended up to fifteen minutes. In treating cases of so-called "fatty heart," the concentration of carbon dioxide is gradually increased, the duration of the baths gradually lengthened to a period of fifteen minutes, and the temperature lowered by degrees until it reaches 85° F. In cases of high blood pressure the temperature of the bath should not be reduced below 95° F. In "nervous"

## FOAM BATHS

Foam baths have been advised for those who find water and mud baths too trying. This type of bath is made by filling a tub to about one tenth of its capacity with water and then adding a foam forming extract and forcing air through the mixture from perforated tubes placed in the bottom of the tub and connected to a pump until the tub becomes full of bubbles. The temperature of the water should range from 95° to 106° F, the period of immersion, from twenty minutes to one-half hour. The patient should enter the bath carefully, he must be told that the supporting power of foam is not like that of water and that he can hurt himself if he lies down precipitously. The bath has a sedative influence and may cause copious perspiration.

## SPONGE BATHS (Figs 17 and 18)

Liquids are applied to the body by means of a sponge, wet cloths, or the bare hand. Sponging with either hot or tepid water has a sedative effect. Sponging with cold water has a tonic influence. For the treatment of itching, the water of the sponge bath may be combined with various chemicals, such as 5 per cent salt or 2 to 5 per cent sodium bicarbonate. To check excessive perspiration, as in the night sweats of tuberculosis, vinegar or salt may be added to the water. The use of a mixture of alcohol and menthol (1 ounce of menthol to 1 or 2 quarts of alcohol) or of alcohol alone evokes a sensation of cold. It has a mild tonic, counterirritant and antipyretic action.

## PARTIAL IMMERSION BATHS

## HALF BATHS

In baths of this type, the patient sits in a bathtub, which is filled with water to about the level of the navel. The hot half bath is started at a temperature of about 102° F, and hot water is added so that the limit of tolerance is reached within five to eight minutes. The forehead may be covered with a cold towel. This form of bath has been employed for diaphoresis, for relief of pain, and for stimulation of peripheral circulation.

In the cold half bath, the patient sits in a tub partially filled with water at a temperature of from 75° to 80° F. The attendant pours cold water on the patient and rubs the body vigorously for three to eight minutes. The patient is rapidly dried with warm towels or a warm sheet. Indications for this bath are the same as those for the drip sheet bath (page 46).

This so-called "Nauheim bath" has been used for many years in the treatment of chronic heart disease. The associated hygienic regime, the removal from scenes which evoke mental tension, the concomittant employment of resistance exercises, enhances the chemical influence of the carbon dioxide. These baths are also advised in the treatment of simple hypertension and in the care of psychic disturbances such as those referred to as psychasthenia, and in insomnia. Heart disease with decompensation and marked arteriosclerosis are contraindications to this form of bath.

#### OXYGEN BATHS

Oxygen may be introduced into the water of a bath from perforated tubes lying at the bottom of the tub and connected to an oxygen tank. In an oxygen bath the temperature of the water should be held between 91° and 95° F. The duration of the bath should be ten to twenty minutes. Its effect is soothing. Nylin advocates its use in the treatment of hypertension, cardiac neuroses and advanced cardiac disease, nervous irritability, and insomnia.

#### BRINE OR SALT BATHS

Brine waters occur naturally at certain spas. Artificial brine baths can be made by the addition of from 5 to 8 pounds of sodium chloride to 40 gallons of water. The tub used should be of wood, because the action of this solution on porcelain and metal is corrosive. The temperature of the water should be between 90° and 105° F.; the duration of the bath, ten to twenty minutes. Where higher concentrations of salt are employed, the increased buoyancy may make it necessary to hold the patient down with straps or weights. Artificial sea-water baths are made by mixing 7 pounds of sodium chloride, 1 pound of magnesium chloride, and ½ pound of magnesium sulphate in 30 gallons of water. Indications for saline baths include osteomyelitis, fractures, dislocations, arthritis, myositis, fibrositis, gout, chronic sciatica, and obesity. Contraindications are arteriosclerosis, cardiac disease, hypertension, and inflammations of the skin.

#### BLAND BATHS

For the relief of itching skin, starch or wheat bran may be added to bath water at a temperature between 95° and 98° F. Five pounds of starch or 3 pounds of wheat bran are mixed with 1 gallon of water. This mixture is then added to 40 gallons of water in the bathtub. The patient may remain in the bath for twenty to thirty minutes, or, if necessary, several hours.

## LEG AND FOOT BATHS

Leg and foot baths may be either hot or cold. Hot leg baths with water at a temperature of from 100° to 105° F, and lasting for ten to fifteen minutes are helpful in treating rheumatic and gouty manifestations, strains and sprains, and muscular pains occurring after exercise. At the conclusion of the bath, the legs are sponged with tepid or cold water. A more stimulating type of bath can be made by adding mustard to the water, a large tablespoonful of table mustard is dissolved in a quart of boiling water and poured into the bath. The mustard bath is used for the treatment of the conditions just mentioned, and also for the common cold and insomnia. It is commonly applied only to the feet. The temperature of the water should be about 103° to 105° F. The feet should be immersed for fifteen to twenty minutes. A hot foot bath that is used for conditions of the feet and also for the relief of pelvic pain and for "colds" is applied for fifteen to twenty minutes, with water temperature ranging from 105° to as high as 115° F, or the system of Kellogg can be followed in keeping the foot in the bath for five seconds and then removing it for five seconds.

On the basis that the cold foot bath with water at from 50° to 70° F causes reflex contraction of the vessels of the brain and pelvic organs, it is employed in treating "congestion" of these organs. It is also used for sprains and contusions of the ankle or foot. The feet should be first warmed and then immersed for periods of from ten seconds to ten minutes. This bath should not be employed during the menstrual period, nor in the presence of acute pulmonary, abdominal, or pelvic inflammation.

## ARM AND HAND BATHS

A large, oval shaped dishpan or special arm bath is used for immersion of the forearm and hand. The water may be hot, cold, or neutral. The hot bath is beneficial for cellulitis, infected wounds, burns, sprains, contusions, arthritis, and circulatory disorders. Alternate hot and cold arm baths are advised in the treatment of lymphangitis.

## CONTRAST BATHS

In contrast baths the extremities are inserted alternately into hot and cold partial immersion baths. One leg is first immersed in a tub containing hot water (100° to 110° F), then transferred to an adjacent tub of cold water (50° to 65° F) (Fig 19). Woodmansey recommends that the extremity be held in the hot water for six minutes and in the cold water for four minutes.



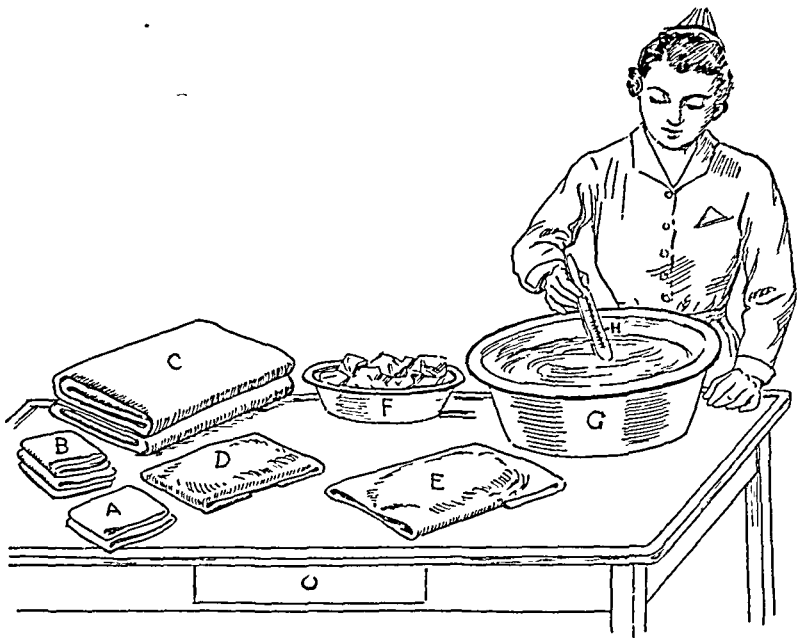

FIG. 17. Sponge bath. Materials: *A*, Two wash cloths; *B*, three small towels; *C*, two bath sheets; *D*, ice cap and cover; *E*, hot water bag and cover (temperature of water in bag  $125^{\circ}$  F.); *F*, basin with pieces of ice; *G*, foot tub with water at  $85^{\circ}$  F.; *H*, bath thermometer.

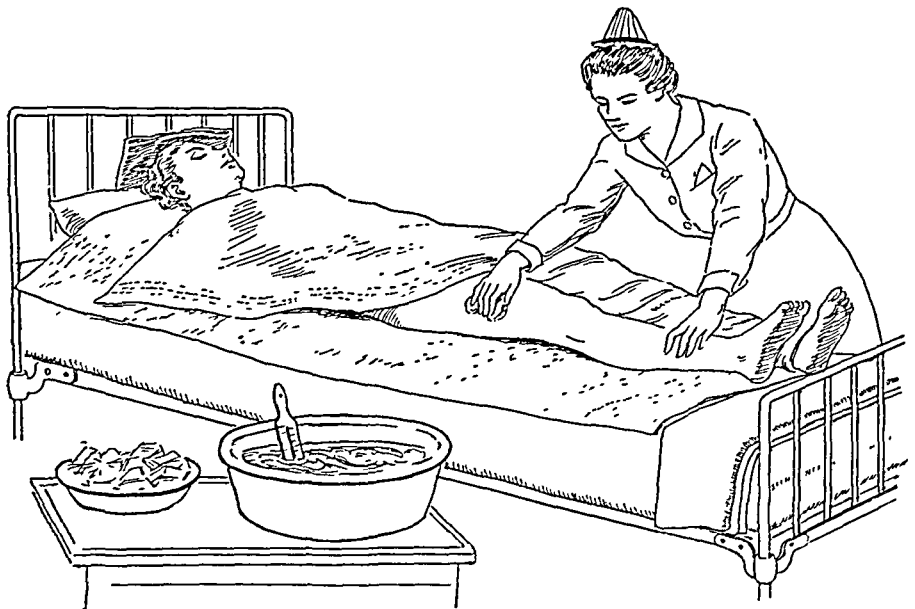

FIG. 18. Sponge bath. Technique: One bath sheet is placed under the patient, another bath sheet covers the patient. An ice cap is placed on the head. A hot water bag may be placed at the feet. All parts of the patient's body are sponged with the exception of the axilla and abdomen. A towel wrung out of water is placed in each axilla and a third towel is spread over the abdomen. These towels are changed at frequent intervals. The water is gradually cooled by adding pieces of ice until its temperature is between  $65^{\circ}$  and  $70^{\circ}$  F. Long broad strokes are best for the bathing. Cloths should be changed frequently.

cordium or if there is a marked increase in pulse rate the bath should be stopped or modified. This technique has been recommended by Hauffe in the treatment of angina pectoris and decompensated valvular disease.

#### WHIRLPOOL BATHS

A local immersion bath which has the effect of mechanical massage is the whirlpool bath (Fig. 20). The water in the bath is agitated by means of an ejector, a turbine, or compressed air, and it is this active motion of air and water that produces a massaging action. Plans for the home construction of the ejector type of whirlpool can be secured from the Council on Physical Therapy of the American Medical Association, 535 North Dearborn Street, Chicago, Illinois. There is an excellent turbine agitated whirlpool bath on the market. When compressed air is available it is a simple matter to introduce it into an arm or leg bath. An effective and inexpensive whirlpool bath may be constructed from an air pump and a washboiler (Fig. 21). The turbine and the compressed and pumped air devices have an advantage over the ejector type in that a continuous flow of water with its plumbing connections and mixing valve to maintain water temperature is not necessary. The temperature of the water in a whirlpool bath usually varies from about 100° to 105° F, but it may be allowed to go as high as 115° F. The arm or leg is held in the swirling water for fifteen to thirty minutes. Bath containers for the upper extremities and for the lower extremities, through which water may be run continuously are available.

The whirlpool bath has a stimulating action on the circulation of blood and lymph. It accelerates regression of inflammatory processes through the rapid diminution of edema and of synovial and other effusions. It exerts a sedative effect, relieving pain and muscle spasm, often enabling feeble and sensitive limbs to be handled and moved with comparative ease. Hand infections which do not progress satisfactorily after incision and drainage usually improve quickly with this treatment. I have observed that the addition of a small quantity of sodium sulfathiazole to the whirlpool bath (10 grams to about 8 gallons of water) hastens the healing of infected wounds. The whirlpool bath may be used to improve the trophic status of the tissues of the extremities after inflammatory and traumatic injuries, limbs that are blue and cold from the atrophy of disuse become warm and red after daily applications of the whirlpool bath, trophic lesions following prolonged suppuration are markedly stimulated, chronic edema and swellings of peri-articular tissues recede. At low temperatures it is applied for its cleansing action on wounds, as well as for its stimulating effect, and to cause the

Krusen obtained the best results when the extremity was held in the hot water for five minutes and in the cold water for two minutes, or when four minutes of heat and one minute of cold was employed. Five, seven, or nine

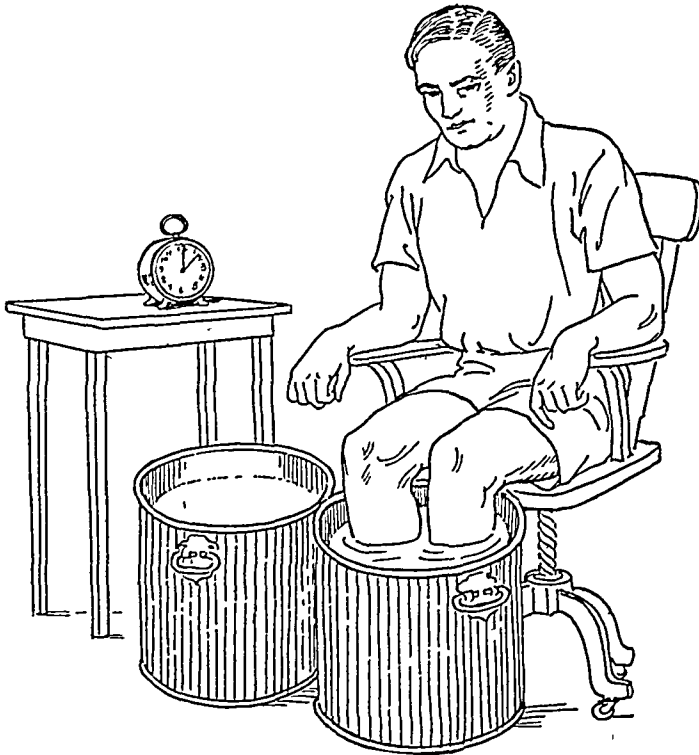

FIG. 19. Contrast leg bath.

such alternate immersions are made. The treatment is begun and ended with immersion in hot water. The temperature of the water is varied in accordance with the condition treated. Contrast baths are used for headaches, arthritis, fractures, peripheral vascular disease, and in the care of sprains and contusions, preceding the use of massage and exercise. If contrast baths are used in the care of peripheral vascular disease, it is necessary to avoid extremes of temperature.

#### GRADUAL INCREASING TEMPERATURE BATH OF HAUFFE

In Hauffe's procedure the arm is placed in a specially constructed arm bath as the patient lies on a bed. Starting with a temperature of from  $95^{\circ}$  to  $99^{\circ}$  F. the water is gradually raised to the tolerance point (about  $115^{\circ}$  F.) during a period of thirty to ninety minutes. The arm is then taken out of the water and the patient kept covered for about one hour. If the patient complains that the bath is too hot or that there is discomfort in the pre-

separation of dead tissue. It is of value in the treatment of painful and adherent cicatrices. Fox pointed out that "when nerves in the vicinity of a wound have been slightly injured but not destroyed, the whirlpool bath at neutral temperatures relieves pain. In these cases other methods of heating may cause an increase in the pain, and so also may manual massage. In cases of amputation the pain referred to the missing hand or foot is rapidly diminished by the whirlpool bath." Baruch stated that in army practice the whirlpool bath is used to treat joint injuries, stiff and swollen joints, painful stumps, scar tissue, bone injuries, old fractures, sprains, partial paralyses and nerve injuries resulting from old gunshot wounds. The bath may be given preceding, or as a substitute, for massage and other mechanical applications to injured limbs. For this purpose, it is sometimes more efficient than other heating methods.

#### SITZ BATHS

The sitz bath is a procedure for applying water to the lower portion of the torso. A washtub, or better still a specially constructed tub, is filled with water to about the level of the umbilicus. The feet and the greater portion of the lower extremities remain out of the water. A modified sitz bath may be administered in an ordinary bathtub if the knees are kept out of the water. The bath may be cold, tepid, or hot.

The temperature of the cold sitz bath varies from  $45^{\circ}$  to  $60^{\circ}$  F, its duration, from five to ten minutes. The skin in contact with the water should be rubbed vigorously. This cold bath produces a tonic effect after a hot application, and is useful when a full cold bath cannot be given. It is recommended in cases of atonic constipation, uterine subinvolution, and delayed absorption of exudates following pelvic inflammation.

The temperature of the tepid sitz bath ranges from  $70^{\circ}$  to  $85^{\circ}$  F. Immersion for two to five minutes exerts a sedative effect which is helpful in insomnia, restlessness, and psychasthenia.

Sitz baths at a temperature of  $110^{\circ}$  F, or as hot as can be borne, may be given for fifteen to twenty minutes daily or even twice daily. If necessary the baths may be started at  $96^{\circ}$  F and the temperature increased gradually. The hot sitz bath is of value in the treatment of pelvic pain, chronic pelvic inflammation, urinary retention, prostatitis, tenesmus, fibrositis of the gluteal area, constipation, flatulence, and meteorism. A hot abdominal pack may be applied following the sitz bath in the treatment of constipation, flatulence, and meteorism. Alternate hot and cold sitz baths are recommended for cases of chronic atonic constipation.

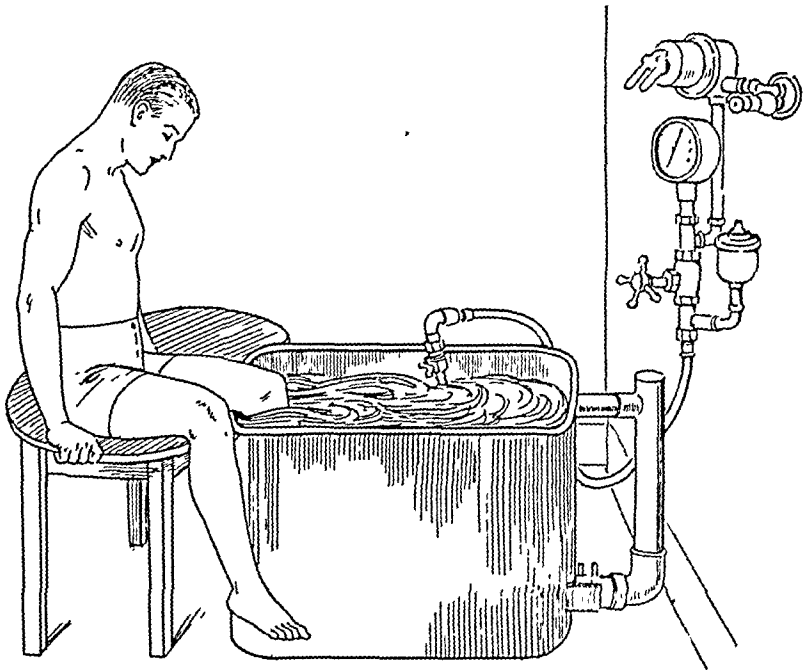

FIG. 20. Leg whirlpool bath. Ejector type.

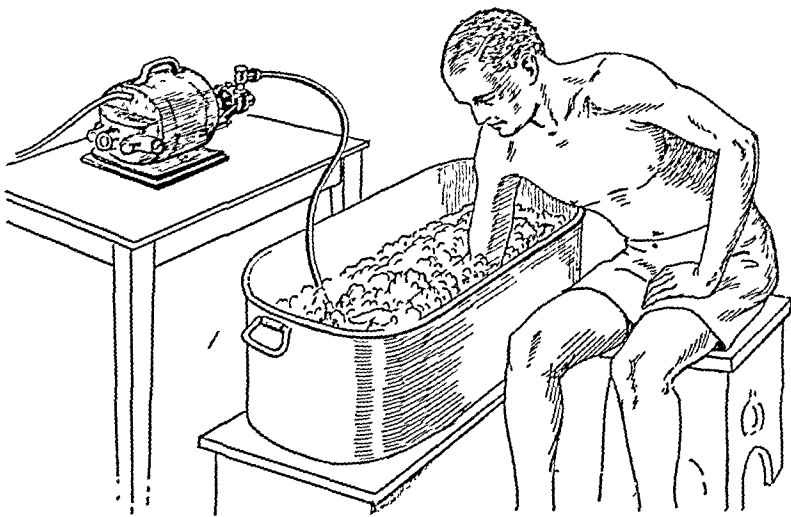

FIG 21. Homemade whirlpool bath for arm. Pump forces air through hose inserted into water contained within wash boiler.

then poured from a jug or similar receptacle on some one part to which friction is applied with vigor. The duration of the bath should be two to five minutes. Indications for its use are melancholia, neurasthenia, and other functional disorders. As with the sheet bath, it should not be used if the patient has not the ability to react properly.

#### TOWEL RUB

The towel rub provides a means for local application of cold for a short duration of time. Large sized linen towels are required and two pails containing water at a temperature varying from 80° to 60° F. One towel is dipped in the water, thoroughly wrung out, and spread quickly around one extremity, as, for example, the right arm. The operator then rapidly applies friction with the palms of his hands over the wet towel. When this towel becomes slightly warm, it is placed in the second pail, and the second towel is applied with the same technique to the other upper extremity. In rapid succession towels are applied to both lower extremities, and then to the anterior and the posterior aspects of the torso. Each part is quickly dried, rubbed, and covered before going on to the next. The entire bath should not take longer than two to five minutes. The number of parts of the body to which the towel bath should be applied depends on the condition of the patient. For example, if the patient appears too ill, the torso may be omitted from the bath. The towel rub serves as a substitute for the sheet bath when patients cannot endure the latter. If the patient's reaction improves, the bath can be used as a preparation for the more vigorous sheet bath. Febrile and chronic asthenic patients also may derive benefit from the towel rub.

#### PACKS

##### FULL WET PACKS

The procedure known as the full wet pack is carried out as follows. Woolen blankets are spread on a mattress over which a rubber sheet has been placed. A smooth linen sheet is wrung out of water between 60° and 70° F. The patient is then placed on the blanket, on his side with his back to the operator. The moist folded sheet is placed lengthwise down the middle of the bed and unrolled over the part of the bed nearest to the operator. The patient is then rolled on to this section, and the other half of the sheet is unfolded over the other side of the bed. While his arms are held raised, half of the sheet is wrapped around the patient. The arms are then lowered to the side and the other half of the sheet is wrapped around him to include

### ABLUTIONS

The abluion is the simplest form of local or general bath. In this procedure, water is applied with the hand, which may be either bare or covered by a bath glove or linen washcloth. A "sponging" technique which does not involve friction should be avoided. The temperature of the water can be gradually reduced from 85° F. at the start to 70° F. Ablutions are employed to reduce temperature in acute febrile disease, particularly in children; and for neuritis, arthritis, and functional nervous disorders.

### AFFUSIONS

An affusion consists of pouring water on the subject from a pitcher or basin or similar source. This procedure may be carried out in a protected bed or in a tub. The height of the vessel above the patient determines the water pressure. The temperature should range from 80° to 60° F. The indications are the same as those for ablutions.

### SHEET BATHS

Sheet baths may be given with the patient in either the standing or lying position. A linen sheet dipped in water at a temperature of from 80° to 90° F. is wrung out, and wrapped around the patient in the following manner: Starting in the region of the right axilla, the sheet is brought across the chest, under the left axilla, and under the back, while the arms are held raised. Then with the arms lowered, the sheet is carried under the right shoulder, the front of the body, the left shoulder and the arms. Friction is promptly applied by the attendant, who vigorously rubs the body through the wet sheet. The feeling of shock disappears as the patient warms up. This should occur within two or three minutes. The patient is then wrapped in dry, warm sheets and the rubbing continued until he is thoroughly dry. He should then rest for fifteen to thirty minutes. Because it produces initial contraction, followed by a dilatation of peripheral blood vessels, the sheet bath has a tonic effect which is beneficial in neurasthenia, melancholia, and other functional nervous disorders. It should be used only when a favorable reaction results; if the patient becomes easily chilled or does not warm up, he should not be given sheet baths.

In the drip sheet procedure, the patient stands in a tub containing water one foot deep and at a temperature of 106° F. A linen sheet saturated with water at 80° F. is wrapped around him; the temperature may be lowered two degrees on each successive daily application. Water at about 70° F. is

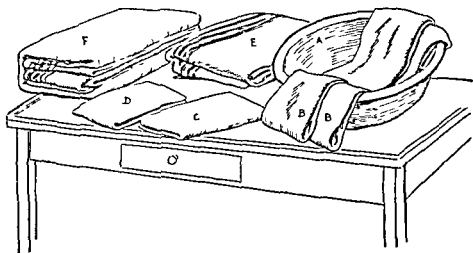

FIG 22 Warm relaxation pack Materials A Foot tub B two drawsheets folded in half lengthwise, C hot water bag with cover temperature of water in bag 125° F D ice cap with cover E cotton blanket F large rubber mackintosh folded in between two cotton blankets



FIG 23 Warm relaxation pack Step 1 The nurse is wringing the drawsheet out of water at a temperature of 100 F This is done after the rubber mackintosh has been placed under the patient and the cotton blanket over him



his arms. The sheet is then pressed down between the legs and the lower end folded under the feet. Next, half of the blanket is folded over the patient and under his trunk and legs, and the other half is then folded the other way. The lower end of the blanket is tucked under the feet. Baruch has emphasized the necessity for complete exclusion of air from beneath the blanket cover. If the feet do not warm up properly, hot water bottles may be placed against them, carefully covered to avoid the possibility of a burn. The pack is continued for one-half to one hour. When administered for conditions other than insomnia, the pack may be followed by an affusion at 70° F. or by a douche or a shower bath. The initial reaction to the pack consists of vasoconstriction of the cutaneous blood vessels which lasts for perhaps one to five minutes. With the subsequent dilatation a reaction occurs and the patient begins to feel warm.

The wet pack is administered for its sedative effect in the treatment of insomnia, psychoses, and delirium. It is also used for the relief of arthritis, myositis, fibrositis, and bronchitis. Because aged persons and children do not react well, they should not be subjected to the cold-warming wet pack; nor should cardiac patients or others unable to react properly. For such patients the relaxing warm pack may be employed. Figures 22 to 29 illustrate a technique for its application. If cold water is substituted for hot, this same technique can be used for a cold wet pack.

#### HALF PACKS

The half pack is a modification of the full wet pack. At times, it serves better to accomplish sedation in an individual who is excited, restless, or suffering from insomnia. Two blankets are spread over a waterproof sheet. Over the blankets is placed a linen sheet wrung out of cold water, and folded around the patient so that it envelops the body from waist to feet. A hot water bottle may be placed at the feet if the patient complains of cold.

#### LOCAL PACKS (Compresses)

##### COLD COMPRESSES

The wet compress affords a convenient method for local application of cold water. Several thicknesses of linen, gauze, or towels are wrung out of water at a temperature of from 60° to 65° F. and placed on the part treated. Flannel bandages may be wrapped around the part to keep the compress in place. It is convenient to have on hand sets of compresses which can be applied to the chest, the abdomen, and to other areas. For the treatment of



FIG 26 Warm relaxation pack. *Step 4* The second wet drawsheet is then placed over the patient

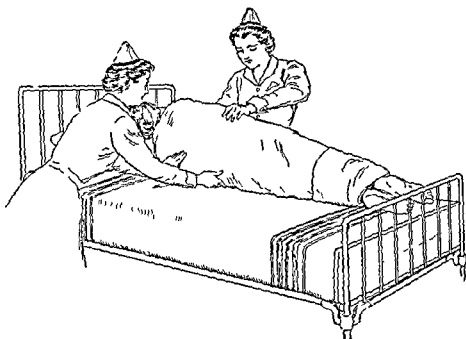

FIG 27 Warm relaxation pack *Step 5* The patient is turned on his side and the sheet is brought over the patient's back, and smoothed out to prevent pressure ridges. The edge of the sheet is tucked under the patient. This procedure is repeated when the patient is turned to the other side



FIG. 24. Warm relaxation pack. *Step 2:* *A*, Bed sheet; *B*, cotton blanket; *C*, rubber mackintosh; *D*, cotton blanket; *E*, wet sheet. The wet sheets are brought to the bedside. Two nurses put the patient in the pack. The patient is turned on his side and the nurse opens half the drawsheet over the bed. The patient is then turned on to the wet drawsheet while the nurse on the opposite side pulls the drawsheet through to the other side of the bed.

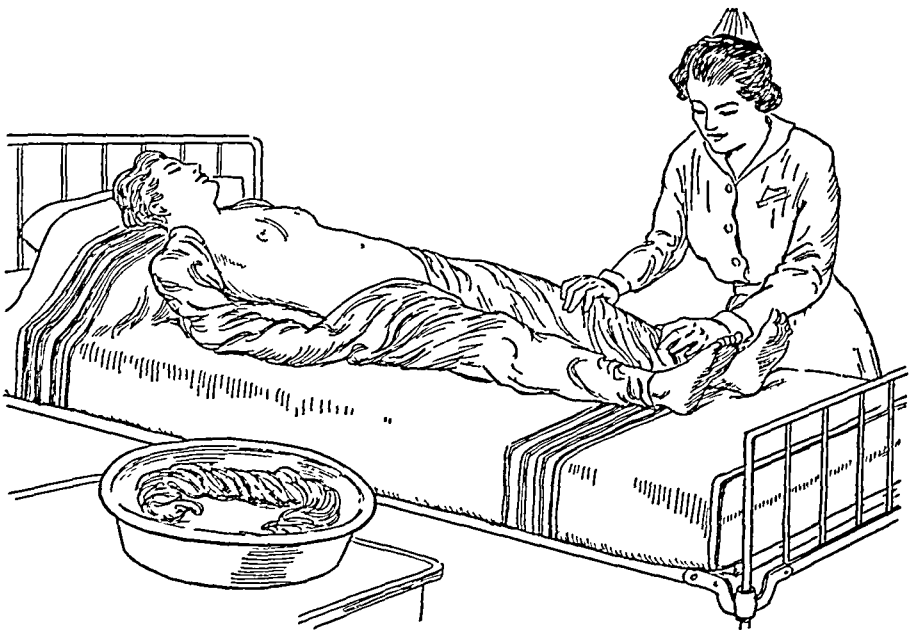

FIG. 25. Warm relaxation pack. *Step 3:* The drawsheet is brought over the patient's shoulders. The arms and legs are wrapped in a manner to prevent two body surfaces from coming in direct contact with each other. The feet are not included in the pack.

chronic inflammations, the temperature of the water for the compress can be reduced to between 50° and 60° F. In applying cold compresses to the eye, care should be taken to avoid damaging the cornea. The precordial compress consists of three or four layers of linen wrung out of water at 40° F. An ice bag or cold coil, which is held in place by a flannel bandage may be placed over the compress for not longer than forty minutes. A local reaction should occur before the compress is reapplied, this usually takes place at the end of about one hour. Cold applied to the region of the precordium in this manner is useful in the treatment of functional arrhythmias, tachycardia, and cardiac decompensation.

#### COLD-HEATING COMPRESSES

This type of compress, originated by Priessnitz, consists of several layers of linen wrung out of water at 60° F. The moistened linen is covered with a layer of flannel which should extend well beyond the margins of the linen in order to exclude all air. Baruch states "It is a *sine qua non* of the cold wet compress that air be excluded from it, because the vaporization of water contained in it by the warmth of the skin renders the latter extremely sensitive to chilling, which is the usual result of an imperfectly applied compress." The reaction of the body to cold causes the compress to become warm and, if left in place long enough, almost dry. Oil silk or other waterproof covering should not be used, because such coverings keep the compress wet, with the result that it has the effect of a wet poultice or dressing. In persons with normal circulation, the reaction causes the compress to become warm in about two to five minutes, in old or debilitated persons, the compress may not warm up, and will therefore cause chilling. In these cases the region should be warmed before the compress is applied, or some other technique should be employed. Cold heating compresses may be applied to the region of the throat in the care of tonsillitis and laryngitis, to the chest for the relief of coughing and pain associated with bronchitis and pneumonia, to the abdomen in gastro intestinal disturbances. When applied to the abdomen it has been referred to as the "Neptune girdle."

#### HOT FOMENTATION COMPRESSES (Figs 30, 31, 32)

The hot fomentation compress offers an effective means for local application of heat. Pieces of old blankets are immersed in boiling water and then thoroughly wrung out by means of a machine wringer until the cloth is moist but not wet. The applications should be renewed every ten or fifteen minutes. Usually, three or four at one time are sufficient to afford relief.

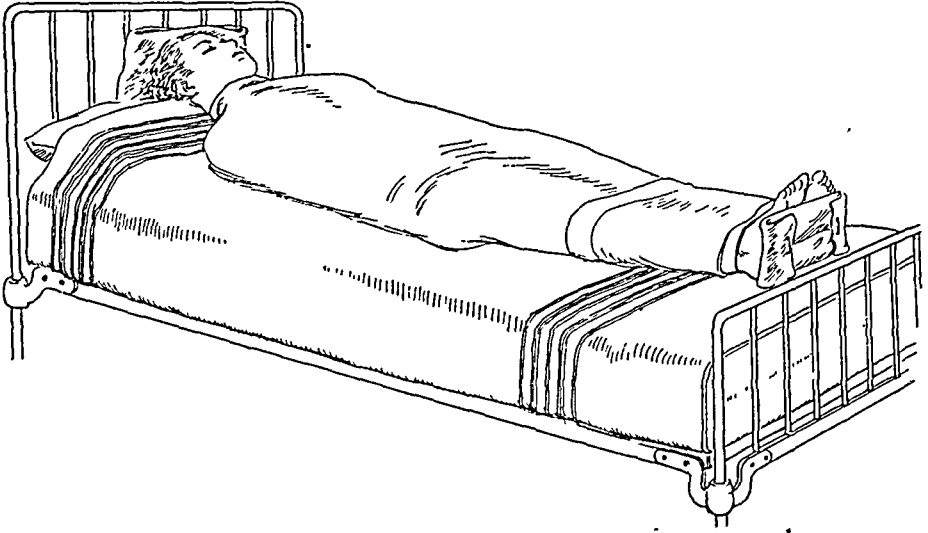

FIG 28. Warm relaxation pack. *Step 6:* The patient is now in the pack. An ice cap is placed at the head, a hot water bag at the feet.

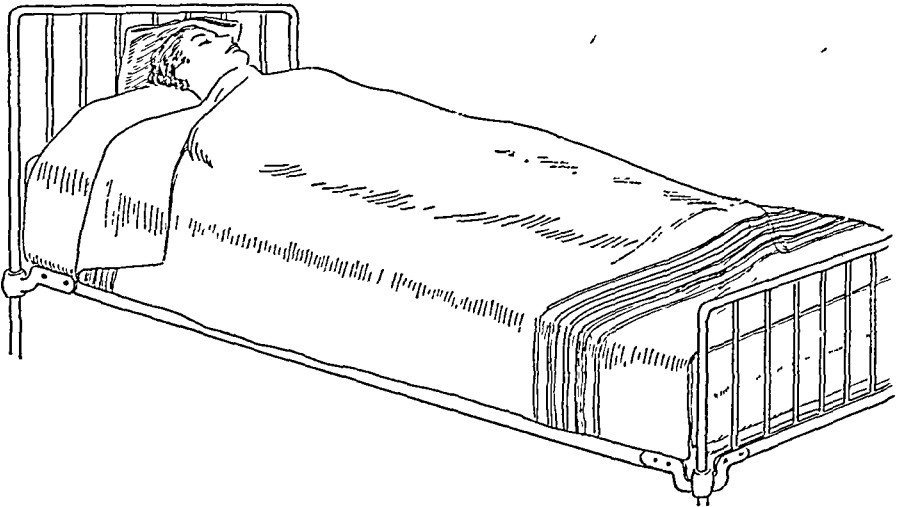

FIG 29 Warm relaxation pack. *Step 7.* The patient is covered with one or two light cotton blankets.

This form of compress may be used in the treatment of sciatica and lumbago. Hot compresses may also be made of gauze or linen or towels dipped in hot water from  $110^{\circ}$  to  $115^{\circ}$  F, and wrung out until they are wet but not drip-

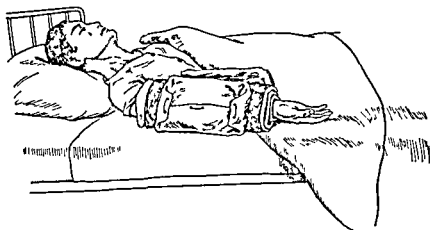

FIG 32 Hot compress to forearm *Step 2* A hot water bag is placed on both sides of the patient's arm. Application of hot water bags contribute to the warmth supplied by the stupe cloth. The stupe cloth may be moistened and warmed at intervals, by syringing with hot water from the irrigating bottle.

ping. The cloth hand-wringer pictured in Figure 33 is suitable for this purpose. These compresses should be renewed frequently, or they may be covered with a piece of oil silk or rubber mackintosh and heat applied continuously by means of a hot water bag or a lamp. An apparatus for maintaining hot compresses at a constant temperature has been described by Cooley. This consists of a coil of electrically heated wire which is placed on a moist compress of flannel and covered with waterproof material. The temperature at which the compress should be maintained depends on the pathological condition. In the treatment of chronic cellulitis, for example, the temperature is held at about  $104^{\circ}$  to  $108^{\circ}$  F. Such compresses have been kept in place for as long as thirty days.

The temperature of the hot compress and the duration of the application should be adapted to the therapeutic objective. Applied very hot for a short period of time, compresses may have a stimulating effect. Prolonged applications at a moderate temperature have a sedative effect, and therefore are used to relieve muscle spasm, to promote absorption of inflammatory exudates, and to allay pain.

A major part of the technique employed by Sister Kenny for the treatment of poliomyelitis consists in the use of hot compresses. Woolen cloths removed from boiling water are passed twice through a tight mechanical

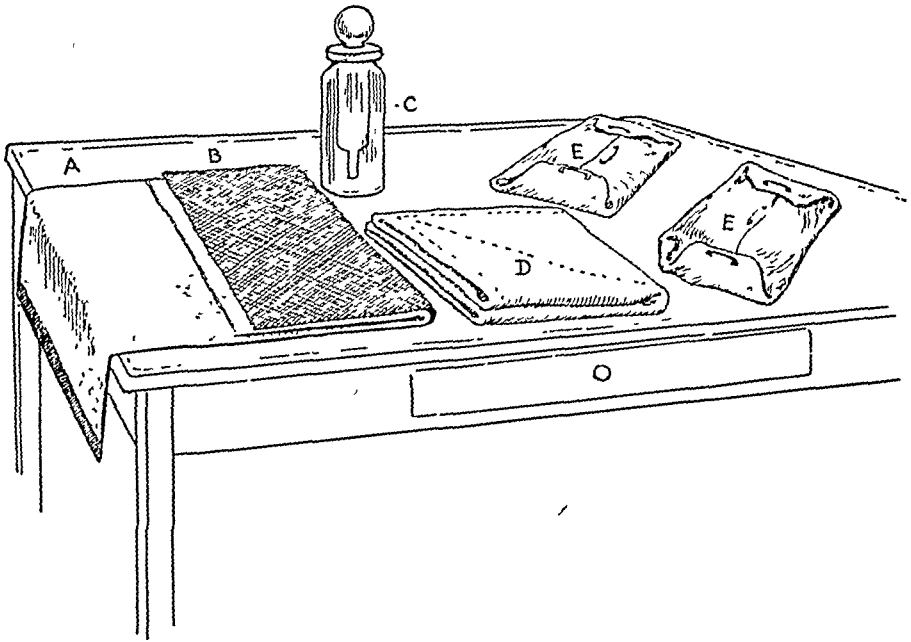

FIG. 30 Hot, wet compress. Materials: *A*, Turkish towel; *B*, rubber mackintosh; *C*, irrigating bottle with syringe; *D*, large stupe cloth (woolen blanket material); *E*, two hot water bags, temperature of water in bags  $125^{\circ}\text{F}$ .

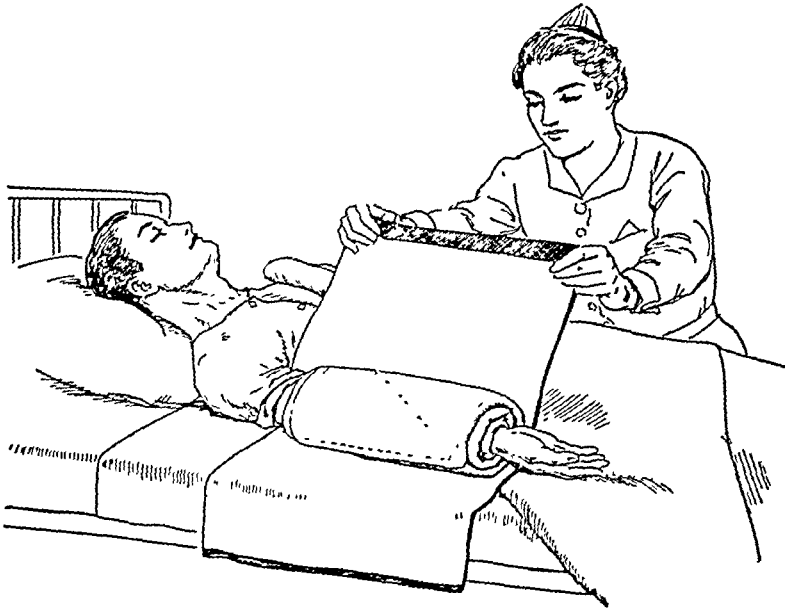

FIG 31. Hot compress to forearm. *Step 1*: The turkish towel and mackintosh are placed beneath the affected area. The stupe cloth is wrung out of the hot water. A stupe wringer may be used. The cloth is then placed around the patient's arm. Both the towel and mackintosh are brought over the stupe cloth.

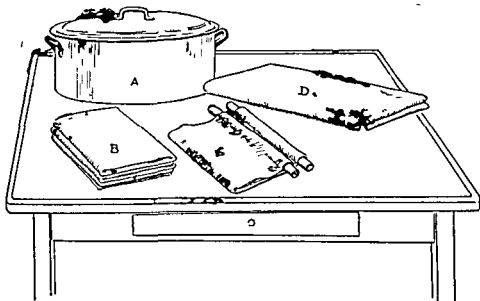

FIG 33 Turpentine stupes Materials *A* Large infusion kettle, *B* three or four stupe cloths (woolen blanket material) *C* wringer, *D* woolen blanket The infusion kettle is filled two-thirds full with water and heated

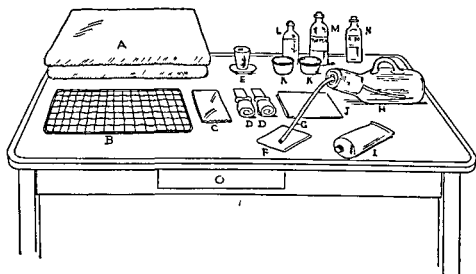

FIG 34 Turpentine stupes Materials *A* Two woolen blankets *B* wire tray *C* paper bag, *D* gauze swabs *E* medicine glass on enamel container *F* several squares of toilet tissue *G* rectal tube, *H* urinal with cotton plug at top *I* tube of vaseline *J* square of oiled silk, *K* two sponge cups one for turpentine and oil and one for albolene *L* bottle of cotton seed oil *M* bottle of turpentine *N* bottle of albolene

The tip of the rectal tube is lubricated with vaseline The medicine glass is used to measure the cotton seed oil and turpentine All this material with the exception of the medicine glass vaseline and bottles are brought to the bedside



wringer and are then applied over the region of muscles to relieve spasm and pain. Hot compresses should be used with caution in regions in which thermal sensations or vascular reactions have been impaired. The reaction produced by the hot fomentation compress may be increased by the addition of substances such as oil of wintergreen or mustard.

#### ABDOMINAL PACKS

For the treatment of flatulence, meteorism, and abdominal pain due to spastic conditions of the colon or other intra-abdominal causes, the hot abdominal pack is a valuable procedure. Preparation for the administration of this pack consists in placing a rubberized sheet and two small blankets, 2½ feet in breadth, underneath the patient on a bed. A flannel pad soaked in hot water at a temperature of 110° F. is placed over the abdomen and around the sides. The blankets and rubberized sheet are then wound over this. A hot water bottle may be placed on top of these abdominal coverings. After the removal of the pack, which is usually kept in place for twenty minutes, a cold or tepid sponge may be applied to the abdomen. Another form of the abdominal pack is the turpentine stupe. The technique of its application is illustrated in Figures 33 to 40.

The so-called "liver pack" is like the hot abdominal pack except that it is placed on the right side and extends from the nipple level to the umbilicus and from the midline in the front to the midline in the back. Ray describes a mustard liver pack for which he uses a piece of toweling or calico folded six or eight times, wrung out of mustard and water, and kept in place for about twenty minutes unless it causes pain. This is followed by local cold sponging.

#### BLANKET PACKS

Dry heat may be applied to the body by means of the blanket pack. The patient is undressed and covered with a hot blanket, for one hour or longer. Hot water bags may be applied to maintain the heat. This pack is used to counteract excessive chilling, to promote sweating, and in states of exhaustion.

#### SHOWERS AND DOUCHES

Kellogg defined a douche as a single or multiple column of water at varying temperatures, pressure, and mass, directed against some portion of the body. Temperatures are defined as: cold, 45° to 65° F.; cool, 65° to 85° F.; tepid, 80° to 92° F.; neutral, 92° to 97° F.; hot, 97° to 100° F. On some occasions the temperature is permitted to go as high as 125° F.

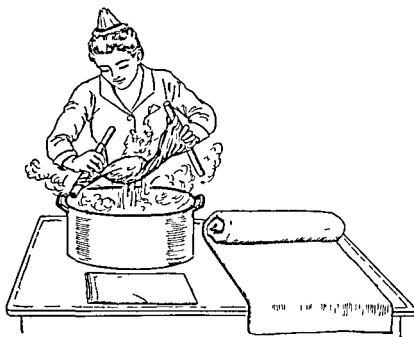

FIG 37 Turpentine stupes Step 3 Three or four stupe cloths are wrung out and placed in the blanket roll

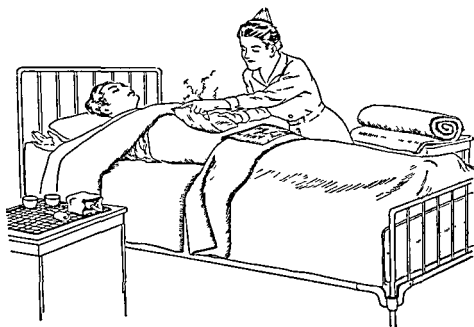

FIG 38 Turpentine stupes Step 4 The chest blanket is now turned up again. A stupe cloth is removed from the blanket roll and gradually applied to the patient's abdomen

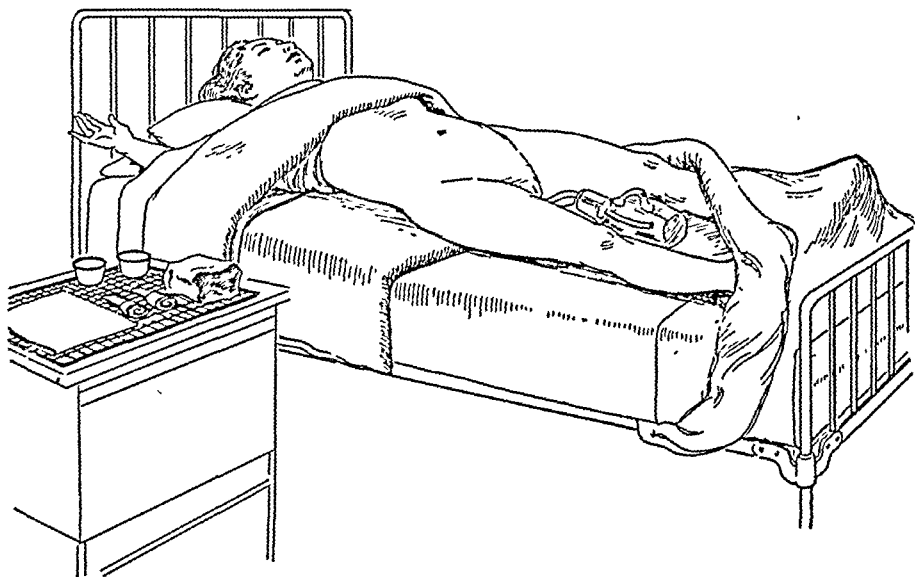

FIG. 35. Turpentine stupes. *Step 1:* The patient is prepared in the following manner. One blanket folded four times in its width is placed under the patient's back. Another, similarly arranged, is placed over the chest. The urinal is placed between the patient's legs and the rectal tube inserted into the rectum.

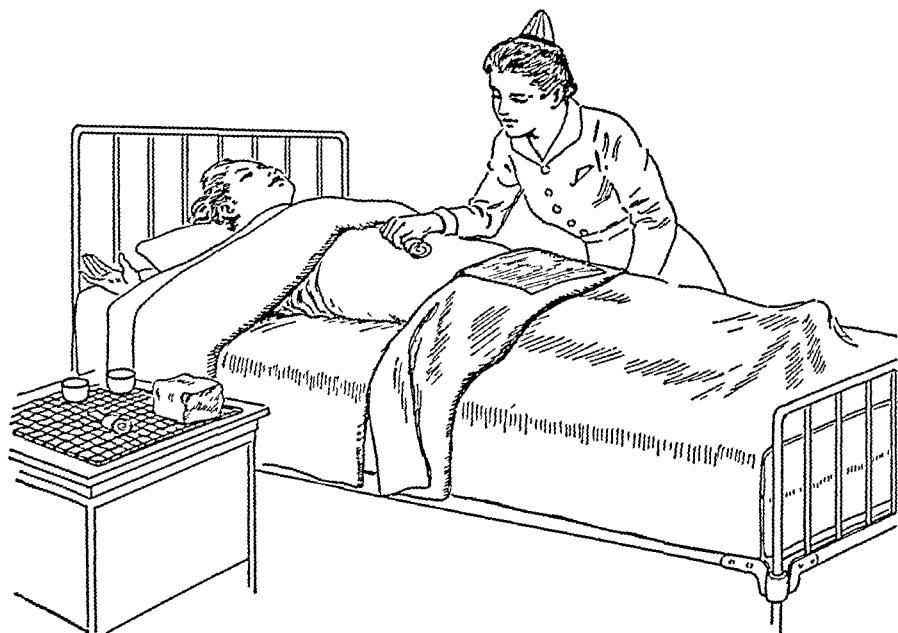

FIG. 36. Turpentine stupes *Step 2:* A piece of oiled silk is tucked under the top bed covering, before the covering is brought over the abdomen. The mixture of turpentine and oil (1 part turpentine to 4 parts cotton seed oil) is applied to the patient's abdomen with a swab which is later discarded into the paper bag. The oiled silk is brought up over the abdomen. The chest blanket is then brought down to cover the patient.

While the temperature tolerance of the tub varies from about 70° to 108° F, that of the douche extends from about 40° to 115° F. The pressure varies from that of a filiform drip in which the column of water is almost as fine as a hair, to one in which the column is an inch or more in diameter. The form of the douche may be a jet, fan, ring, filiform, or needle. The direction may be horizontal, vertical, multiple circular, appending, or depending. The rationale of the douche, according to Baruch, is "to stimulate by thermal and mechanical excitation the cutaneous nerves from which effects are conveyed to the central nervous system and reflected upon organs, the functioning of which is to be enhanced." He called it a form of neurovascular training by repetition with lower temperatures and longer duration at each treatment because the reaction of the cutaneous nerves is gradually improved until the patient responds readily to a procedure which he could not tolerate in the beginning.

The most commonly employed douche is the ordinary shower bath. While its primary purpose is cleansing, it does cause a tonic reaction, depending on the temperature at which it is used and the state of health of the individual receiving it. For hydrotherapeutic purposes the overhead spray is generally placed on one side so that the water strikes the body's surface at an angle rather than from directly overhead. This arrangement is referred to as the rain spray. Below the head, water is made to impinge on the skin surface from a circular shower arrangement, which is called the "needle shower," because of the sensation which it evokes when thin streams of water strike the skin with some force.

For the most effective administration of douches, a special control table or similar arrangement is employed. This is equipped with a thermometer and pressure gauges to allow the operator to determine exactly the temperature of the water and the pressure at which it issues from the short hose through which it is applied. This douche table is placed opposite the circular douche and 12 feet away from it. The patient stands within the circular douche. If the patient is less than 10 feet from the douche table, the return spray may strike the operator. If he is more than 12 feet away, the stream may be too feeble. Treatments given by means of the douche are described as tonic, eliminative, and reducing.

#### TONIC DOUCHES

As a preliminary to the tonic douche, the patient is placed in a hot air cabinet until he is warm but not perspiring. The first douche is applied at a temperature of 90° F for ninety seconds, under 25 pounds of pressure. There-

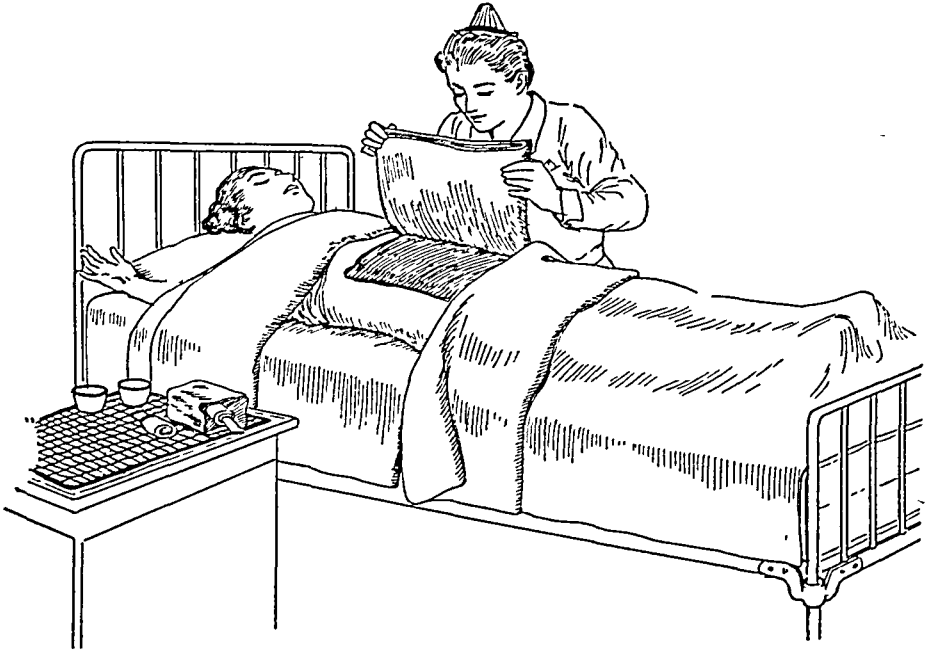

FIG. 39. Turpentine stupes. *Step 5:* The oiled silk is brought up to cover the stupe cloth. The folded blanket underneath is brought around the patient's body.

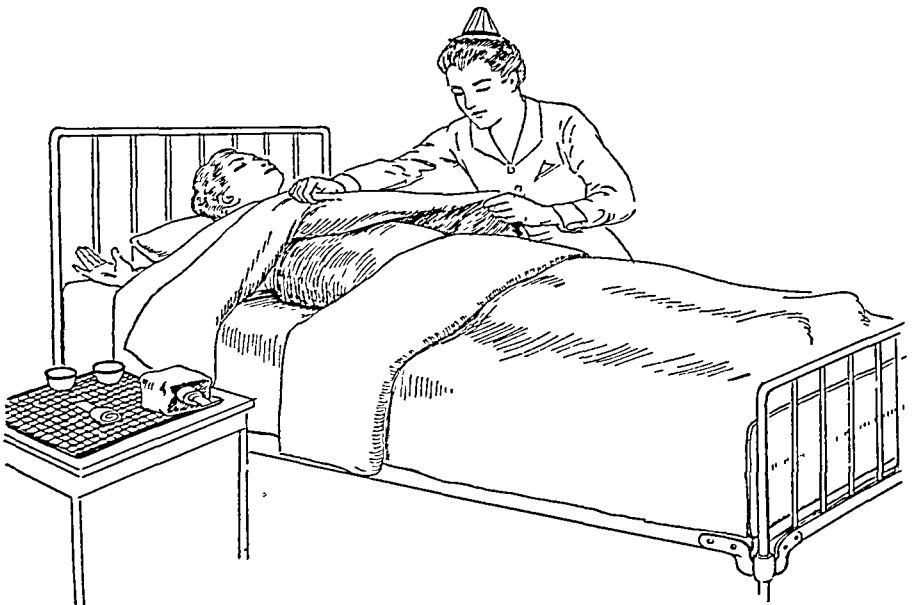

FIG. 40. Turpentine stupes. *Step 6:* The top blanket is either brought down or the lower bed covers are brought up over the upper blanket. Each stupe cloth is left on for three or four minutes. At the end of that time the procedure is repeated until all of the stupe cloths have been used. At the termination of the treatment, the second swab is dipped into the sponge cup containing albolene. Albolene is applied for its soothing effects and to remove any turpentine which may still be on the abdomen.

35 pounds The cold douche is an energetic form of treatment and is therefore contraindicated in conditions such as heart and renal diseases, arteriosclerosis, nervous irritability, the rheumatic states, and neuritis

#### NEUTRAL DOUCHES

The neutral douche is applied at temperatures from 92° to 97° F, for periods of two to twenty five minutes While the pressure may vary from 2 to 30 pounds, it is usually not more than 5 to 10 pounds, inasmuch as this type of bath is ordinarily employed for its sedative effect The water is permitted to issue in a fan shape from the nozzle This type of douche is used for its sedative influence on states of nervous irritability and insomnia

#### HOT DOUCHES

The hot douche is applied at a temperature ranging from 104° to 125° F., averaging about 115° F Its duration varies from fifteen to thirty seconds to five minutes, and the pressure at which it is administered varies from 5 to 10 pounds If the temperature of the water is higher than 115° F, the nozzle of the spray must be kept in constant motion The treatment is usually begun at a neutral temperature of about 90° F and this is increased rapidly until the maximum is reached in about one half minute The influence of this type of douche is like that of a hot bath with percussion added, at first it is stimulating and later relaxing Initially, there is temporary contraction of the cutaneous blood vessels, quickly followed by general relaxation The heart rate is at first slowed and then increased The blood pressure rises and then falls The application is more comfortable if a cold, wet towel is placed on the head and neck The hot douche is employed for the relief of pain in neuralgic conditions

#### SCOTCH OR CONTRAST DOUCHES (Fig. 41)

With the Scotch douche, hot and cold douches are applied alternately, either to the entire body or to some local area As a preliminary, the body is first heated in a cabinet or a Russian or a Turkish bath, or in some other manner Hot water is first applied at a temperature of 100° F, this is rapidly increased to 120° F and then lowered to 105° F before changing over to the cold Cold water, from 50° F to 65° F is administered for five to twenty seconds The pressure at which the cold water is applied varies from 10 to 20 pounds, that of the hot water from 5 to 10 pounds The entire application should not take more than ten to twenty minutes Fan, jet, or spray douches may be used The jet douche is the most satisfactory, because of its percussion

after the temperature is reduced one degree daily. After it reaches 70° F. the duration of the douche is increased ten or twelve seconds a day. Treatments should never exceed five minutes.

The fan douche is produced by pressing the tip of the index finger of the hand holding the nozzle on the stream issuing from it. This fanlike stream is slowly passed over the entire body from head to foot, beginning with the back, proceeding to the front, and finishing with each side. Each day the fan douche is made coarser by diminishing the pressure of the finger tip over the nozzle point until by withdrawing the finger altogether, it becomes a jet douche. This tonic form of treatment is used in the care of neuroses and neurasthenia.

#### ELIMINATIVE DOUCHES

The eliminative douche is given after the patient has been in the hot air cabinet and has perspired actively there for five minutes. The circular douche is then administered. It should be started at 100° F. and gradually reduced to 90° F. or less and should last for two minutes or longer. This type of treatment is administered for rheumatic and gouty states.

#### REDUCING DOUCHES

In the reducing treatment the patient should stay in the hot air cabinet for ten or more minutes after perspiration appears. During this time he should drink one ounce of water every three minutes. Following this, the circular douche is applied, starting at 100° F. and decreasing to 90° F. After the patient has been dried thoroughly with a coarse towel, he is permitted to go home.

#### COLD DOUCHES

The cold douche usually follows some procedure of a heating nature. Its temperature usually varies from 50° to 80° F. with an average of about 60° F. Its duration should be very brief—from five to thirty seconds, with a pressure of 5 to 30 pounds. It may be applied in any form such as a jet, fan, and the like. It has both a thermal and mechanical effect, stimulating metabolism and increasing muscular irritability and capacity. It is used for general tonic purposes in a gradual development of reactive powers. It may be necessary to apply it at first at a temperature as high as 90° F. The water is gradually made colder during subsequent days until a reaction is obtained when a temperature of 50° F. is applied for a few seconds. As the temperature is decreased, the pressure may be increased from about 10 pounds to 30 or even

## STEAM DOUCHES

Steam under pressure and applied through a flexible hose is a good form of treatment. In the care of myositis and sciatica it is played over the painful regions. It is also employed to stimulate sluggish wounds such as varicose

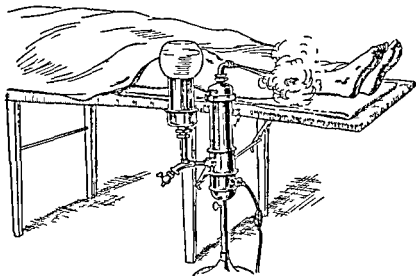

FIG 42 Steam douche applied to leg ulcer

ulcers. The distance from which the steam is applied should be determined by the effect produced, the patient should feel a sensation of comfortable heat. If the treated part is held too near burns may result. A simple contrivance for giving steam douches, which is available for office use, is a steam vaporizer, the nozzle of which may be directed at the region to be treated (Fig 42).

## IRRIGATIONS

Alone or combined with various substances, water is used for irrigation and injection purposes. Irrigations are applied to the upper respiratory, gastro intestinal, and genito urinary tracts in both sexes, to the eyes and ears, and to wounds.

## REFERENCES

- BARUCH, S. *The Principles and Practice of Hydrotherapy*. New York, William Wood, 1899.
- COOLEY, K. New apparatus for maintaining hot compresses at a constant temperature. *Arch Surg* 37: 123-131, 1938.
- CURRENCE, J. D. Underwater therapy in arthritis. *Arch Phys Therapy*, 16: 291-294, 1935.



effect. The application is first made to the back and then to the front of the body, the patient turning several times during the course of the treatment. In patients who are intolerant of extremes of cold, the temperature range

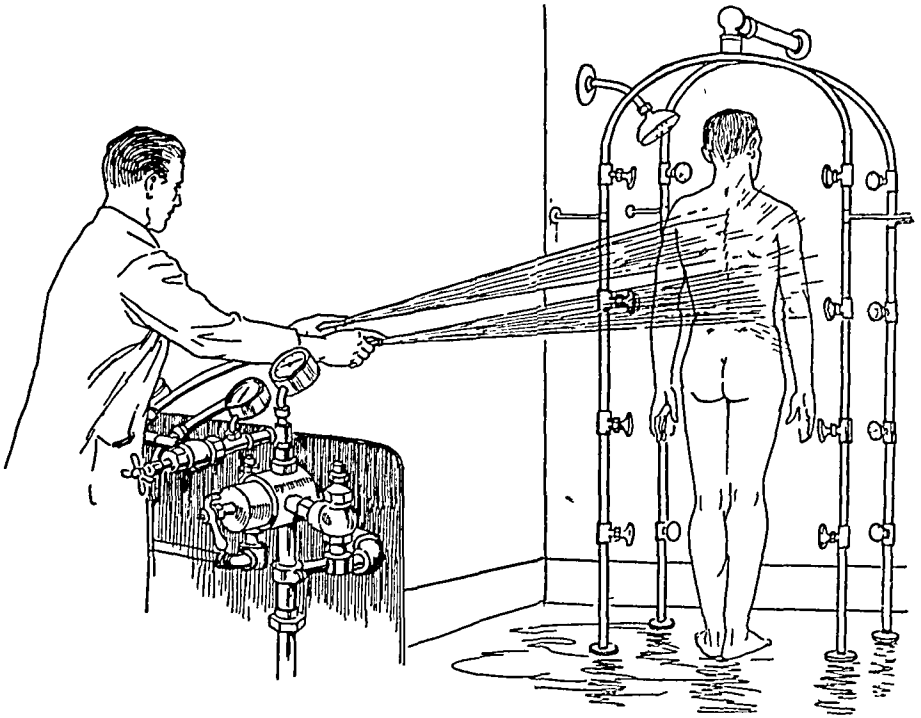

FIG. 41. Scotch douche.

should be between  $20^{\circ}$  and  $30^{\circ}$  for the first day or two. Subsequently this range may be gradually increased. The aim is to secure greater extremes in temperature in order to accomplish greater effects. The tonic action of the Scotch douche is used for its refreshing effect in normal persons; in insomnia; and in the rheumatic states, including myositis, fibrositis, and arthritis; and in chronic alcoholism. Locally it is useful in the care of lumbago, sciatica, neuralgias, and similar conditions. The Scotch douche should not be applied in the presence of severe illness or organic disease such as that involving the cardiovascular system.

Massage, combined with douche treatments, may be administered to the patient in either a lying or a sitting position. These combinations are referred to as the "Vichy" douche and the "Aix" douche, respectively, because of their employment in these French spas.

### CHAPTER III

## CLIMATOTHERAPY AND SPA THERAPY

**M**AN IS THE PRODUCT OF HIS HEREDITY, FOOD, AND environment Of this triad, environment is an important factor both in health and in disease The part played by rapidly changing environmental factors has become increasingly important with the development of the modern trend toward atmospheric alterations on the ground (air conditioning), above the earth's surface (aviation), and below it (subterranean and submarine activities) That man can exist only within certain environmental limits and that alterations in the environment can be purposefully applied to improve his health has long been recognized We can think of ourselves as animal organisms living at the bottom of an ocean of air which surrounds the earth's surface The physical constituents of this ocean compose our climate The components which have a direct influence on health include temperature, humidity, motion and pressure of the air, visible and ultra-violet radiation, and the electrical, solid, and gaseous elements Changes in these physical factors during a brief period of time are spoken of as changes in "weather" Characteristic alterations during a long period of time (over years) are referred to as "climate" Different parts of the world show characteristic variations in weather and climate

Of all the physical elements of climate, those which affect the body's ability to lose heat are the most important These include the temperature of the air, its moisture content, air movement, and radiation transfer between the body and surrounding surfaces It has been suggested that the effects of these four environmental factors in controlling heat exchange between the body and the atmosphere be combined into a single index of comfort, known as the "effective temperature"

The temperature of the air depends on the physical factors of its locality These include its latitude, altitude, and the relative distribution and characteristics of its land and water, such as the presence of mountains and oceans

- FOX, R. F. *Physical Remedies for Disabled Soldiers*. New York, William Wood, 1917.
- GROEDEL, F. Personal communication. New York, May 11, 1942.
- HEDIGER, S. Recent researches on natural carbonic acid baths. *Arch. Med. Hydrol.*, p. 87 (June), 1923.
- KELLOGG, J. H. *Rational Hydrotherapy*. Philadelphia, Davis, 1901.
- KRUSEN, F. H. *Physical Medicine*. Philadelphia, Saunders, 1941.
- LEWIS, T. *The Blood Vessels of the Human Skin and Their Responses*. London, Shaw & Sons, 1927.
- LOWMAN, C. *Technique of Underwater Gymnastics; A Study in Practical Application*. Los Angeles, American Publications, Inc., 1937.
- NYLIN, J. B. Physical exercise in cardiac conditions. *Med. Rec.*, 149: 373-376, 1939.
- RAY, M. B. *On Prescribing Physical Treatment*. New York, William Wood, 1929.
- WOODMANSEY, A., COLLINS, D. H., and ERNST, M. M. Vascular reactions to contrast baths in health and in rheumatoid arthritis. *Lancet*, 2: 1350-1353, 1938.

teria" The "air-conditioning" ability of the upper respiratory tract is put to great stress and strain by the sudden changes which occur when an individual goes from the warm, dry climate of the heated indoors to the cool, relatively moist air of the outdoors Mudd and Grant and others have shown that reflex vasoconstriction and ischemia occur in the mucous membrane of the upper respiratory tract when the body surface is chilled

In a cold environment, artificial heating and clothing diminish the loss of heat from the body and so interfere with metabolic changes Environmental factors which encourage heat loss stimulate the basal combustion rate, those factors which cause a reduction in heat loss diminish the metabolic responses The most beneficial influence of climate would be secured when living outdoors in a comfortable environment and wearing little, if any, clothing Age plays a part in determining the comfortableness of climate Young, vigorous persons prefer a relatively cool climate, older persons, the warmer regions of the subtropics

Mills has described the influence of climate on bodily activities The ease with which waste heat can be lost from the body influences growth and reproduction, the production of immune bodies, the resistance to infection, thought and energy for action, and other basic bodily processes Metabolic stress is greatest in the middle temperate latitude and declines toward the regions of extreme heat and cold In America and Europe, therefore, the tempo of existence is highest

Seasonal variations in climate cause physiological alterations, and are therefore of particular importance in the presence of disease During the summer warmth, there is a feeling of relaxation and lethargy, during the winter cold, a feeling of greater vigor With the increased metabolic activities occurring during winter, the machinery of the body is put under greater stress Therefore, according to Mills, the breakdown of exhaustive types of diseases, such as heart and circulatory failure, pernicious anemia, diabetes, nervous exhaustion, and toxic goiter is accentuated The increase in blood pressure that occurs during the cold season is disadvantageous for the individual with hypertension Because the ability to resist infection is greater during cool weather, it is suggested that major operations when possible be avoided during the summer heat It is said that typhoid vaccine injections do not produce the same degree of protection when administered in tropical heat as they do when given under more invigorating climatic conditions

Patients who suffer from rheumatic manifestations feel approaching atmospheric changes Whether the ability which these individuals have to foretell these changes is due to alteration in the electrical content of the

In general, land is a poor reflector and conductor of heat; it absorbs heat readily and gives it back-readily. Water reflects some of the heat of the air above it; it conducts and retains heat better than land does.

The moisture content of the air is expressed in terms of its "humidity." "Relative humidity" indicates the percentage of the total amount of vapor which can be contained by the air. The actual amount of vapor in the air is referred to as the "absolute humidity." Humidity is highest in hot climates and at sea level. The body depends on the evaporation of its perspiration to keep itself cool in high temperatures. Considerable moisture content in the air interferes with such cooling. Rainfall is heaviest in those regions where large surfaces of water are exposed to evaporation and where the upper air is suddenly chilled. These conditions are fulfilled in mountainous regions where the moisture is precipitated as rain on the windward side of the mountains, because of the sudden cooling of the air as it is deflected upward.

#### PHYSIOLOGICAL EFFECTS OF CLIMATE IN HEALTH AND IN DISEASE

All the physiological mechanisms of the body are affected by atmospheric forces. The skin is the primary organ through which these influences are mediated. The effects may be direct upon the body or reflex from its surface. The reflex influences affect the entire vegetative system. The most important influence is exerted on the mechanism of heat control. This has been discussed in Chapter I. In a hot, humid atmosphere the blood vessels of the skin dilate and a large amount of body blood is contained near its surface. In cold air, the blood vessels of the skin contract.

The direct effects of climate are observable in the mucous membrane of the upper respiratory tract. Hill and Murcke have shown that outdoors in a cold, moving atmosphere, the mucosa of the nose is pale and taut. On the other hand, indoors, even in a ventilated room, heated to an average degree, the nasal mucosa becomes swollen, flushed with blood and covered with a thick secretion, and pits when it is pressed with a probe. In this state, according to McLeod, the blood flow is diminished and so also are the natural defensive mechanisms against the local growth of bacteria. This favors the development of rhinitis, pharyngitis, tracheitis, and bronchitis. McLeod states: "After becoming acclimatized to outdoor conditions, the nasal mucous membrane is in a much more favorable condition to withstand infection than indoors because of the very rapid blood flow that is necessary in order to supply the heat with which to warm up the inspired air. This more rapid blood flow and the freer flow of lymph which accompanies it is reinforced by the increased secretion which assists in washing away any invading bac-

pH Cheynes-Stokes breathing develops at great heights. At moderate heights, blood pressure increases in persons making a transitional change, but is not altered in residents of mountainous districts. Much water is lost through the lungs. At 26,000 feet the water vapor tension is only 6 per cent of that at sea level, so that there is evaporation of large quantities of water from the respiratory tract, as well as withdrawal of heat from the body. As a person becomes adapted to altitude, there is an increase in the number of red blood cells, in the quantity of the blood, in the hemoglobin, in the rapidity of circulation, and in the respiratory and pulmonary volume.

Rheumatic infections are most common in the cooler and stormier regions of the earth, and relatively uncommon in the warmer, less stormy tropical and subtropical areas. The incidence of respiratory infections, including bronchitis, pneumonia, and pulmonary tuberculosis, is higher in the winter than in the summer. The physiological effects of sunshine are dependent on its ultraviolet, visible, and infra red radiations. These subjects are discussed in their respective chapters.

According to Pottenger, the ill effects of meteorological forces may be noted in the clinical course of a disease such as tuberculosis. Hemoptysis, pain, insomnia, pleural effusion, metastatic spread, and exacerbations appear seasonally, and also appear in multiples at the same season, being precipitated by storms. Most exacerbations and most spread of the disease occurs in the late winter and early spring, after the patient has been long subjected to the stresses of winter weather. A period of lesser severity is observed in the fall. Endocrine function and sensitivity of the components of the vegetative system all show seasonal changes. In the winter, the tissues are more active, cells more permeable, and potassium more prominent than calcium, in summer the reverse is true. It is obvious that there should be a seasonal difference in the incidence of those diseases which are seasonally as well as atmospherically conditioned.

It is yet to be determined whether the ionic content of the atmosphere has a medical significance. Ions are electrically charged atoms, molecules, or molecular groups. These charges may be either negative or positive. The existence of ions in the atmosphere is due to the bombardment of molecules in the air by cosmic rays coming from interstellar space, by solar radiation, and by radio active materials on and below the surface of the earth. The aspirating action of winds and the fall of barometric pressure cause the ionized gases to be diffused through the capillaries of the soil into the air. About 60 per cent of the total ionic content of the air near the surface of the earth is due to gases from the soil. The condition of the atmosphere deter-

atmosphere or to other factors, is problematical. It is known that changes in barometric pressure influence the physiology of the body. Smith observed that the body acts like a sponge in that there is an increase in water content of the tissue with falling pressure, and a decrease, with rising pressure. He found an increase of as much as one-half inch in the calf of the leg following a day of declining barometric pressure; with an upward turn in atmospheric pressure, these measurements diminished. The tissue swelling that occurs at low pressures may be due to water removed from the free-water stores in the intestinal tract or the blood stream. Alterations in mental capacity occur with fluctuations in atmospheric pressure. Suicides are said to increase when barometric pressure declines. Attacks of severe headaches or fainting spells develop most frequently during low pressure periods, in persons prone to such attacks. Other changes which are reported to result from lowering of barometric pressure include increase in blood sugar, decrease in blood pH, variations in gastric secretion, stimulation of the hematopoietic functions, and increased volume of respiration and blood supply to the lungs.

The physiological alterations due to changes in altitude vary in accordance with the speed with which they occur and with the time during which a person is exposed to the elevated altitude. Airplanes make the transition from sea level to extremely high elevations within minutes. The symptoms produced by such sudden changes are due primarily to diminution of the oxygen content of the atmosphere, although other factors, such as reduction in barometric pressure and extreme changes in temperature, play an important part. In mountain-climbing there is a more gradual adaptation to the climatic changes which occur in the transition from sea level to high altitudes. The relatively gradual ascent allows mountain climbers to reach a level of 20,000 feet without the use of oxygen, whereas in airplanes oxygen becomes necessary at about 16,000 feet. According to Ray, the symptoms produced by high altitudes are lassitude, apathy, palpitations, nausea, sometimes vomiting, dyspnea, shivering, headache, vertigo, un-co-ordinated movements, weakness of memory, sleeplessness, and occasionally diarrhea. Changes at high altitudes described by Durig include increase in the number of red blood cells; marked cyanosis; increase in the quantity of blood and circulation; and increase of hemoglobin, residual nitrogen, cholesterin, glutathion, and lactic acid. There is a decrease in reserve alkalies and a diminution in the amount of oxygen in the blood. The simultaneous decrease of carbon dioxide tension, which permits an increase in the oxygen combining power of the blood, is interfered with by the formation of other acids with a resultant increase in

Residence in the Southwest meets what Mills terms the second important consideration for the care of tuberculosis, namely, avoidance of winter hazards brought about by epidemics of acute upper respiratory infections. However, opinions differ as to the climate most suitable for patients with pulmonary tuberculosis. More important in the treatment than climatic considerations, is the carrying out of a suitable regime of exercise, rest, and diet. As Pottenger says, "I would rather be treated intelligently in the worst climate than be allowed to run wild in the best."

The southwest portion of the United States is also suited to the care of rheumatic conditions, including rheumatic arthritis and rheumatic heart disease. Patients with rheumatic heart disease, however, should avoid high altitudes. According to Mills, the warm, moist climate of the Florida peninsula and the Gulf Coast offers possible relief to sufferers from metabolic diseases, such as diabetes, toxic goiter, pernicious anemia, leukemia, and Addison's disease. Although modern treatment permits diabetic patients to be adequately cared for in relatively unfavorable climates, the advantages of a warm climate should be sought for young patients and those whose social and economic ties permit them to be transferred readily. Cardiac patients suffering from sclerotic changes which may be accompanied by hypertension do best in the warm, moist regions of the South. The sedative climate of the South is suitable for mentally disturbed patients who have gone through a period of tension (Psychotic patients require institutional care). Residence in the warm South increases susceptibility to upper respiratory tract infections on migration to northern climates during the cold and stormy seasons. This holds true for both the native and the northerner who has spent several weeks in the South.

*The Ocean* Marine climates, both at sea and on the seacoast, are characterized by relatively equable temperatures, because heat is absorbed by the water during the day and given off during the night. The humidity of the atmosphere is relatively high. The advantages of a sea voyage include the equable temperature, comfortable degree of humidity, and purity of air, rest and quiet, change of scene and manner of life, open air life with plenty of sunshine, and the exhilarating and bracing effects of motion through air caused by the sea breezes. Burney Yeo says "The sea voyage, for persons whom it suits, may be regarded as a combination of sedative and tonic influences, increasing the appetite, stimulating the nutritive processes and favoring repose of mind and calm sleep." However, a patient's inclinations should be consulted before a sea voyage is prescribed. To some, the monotony may prove irksome. Dr. Samuel Johnson said "A ship is a prison with a



mines the relative distribution of the various-sized ions. The number of ions in the air varies from 50 to 10,000 for each cubic centimeter of air, depending on many factors. They are higher in number during the day than at night. They are much more numerous on clear, sunshiny than on foggy and rainy days, and also much more numerous in summer than in winter. The atmosphere contains both negatively and positively charged ions. One or the other may predominate in number; on mountain tops negatively charged ions predominate. With the approach of thunder storms, the number of positive ions becomes greater. Ions of opposite charge may combine to form neutral ions.

#### THERAPEUTIC USE OF CLIMATE

A change of abode, either temporary or permanent, may have physical advantages for normal persons as well as for those who are suffering from certain diseases. Practically all the possible beneficial climatic advantages are to be had in the United States and the American continent. It would appear logical to evaluate the physical status of the prospective vacationist and to suggest some locale for his holiday activities which would enhance the benefit he might secure during this period of change. In Europe a sojourn at a spa is a common method of spending a vacation. According to Singer, the instinctive motivating factor toward migration is a desire for a climatic change, the effects of which may be either sedative or stimulating.

When a change of climate is desirable for a person who is ill, his constitution and the nature of his disease should determine whether the climatic change be to temperate or subtropical zones; to low altitudes on the sea coast, ocean, or inland; or to high altitudes. While changes in climate may exert a profoundly beneficial influence, there exists no absolutely curative climate; only climates favorable to certain constitutions and to certain types of disease.

*The South.* The southern section of the United States presents a relatively warm climate the year around. In general, that portion of the South including Florida and the Gulf Coast region is characterized by a warm and relatively moist climate. The Southwest, particularly Arizona and New Mexico, is characterized by a warm, dry climate, relatively free from storms, which appears to be particularly valuable for the treatment of chronic sinusitis, bronchitis, asthma, and bronchiectasis. For many sufferers from upper respiratory tract diseases, a permanent change in residence to the Southwest is desirable, because return to the colder, moister, and stormier climate may cause a recurrence of their symptoms.

shortly disappear. Many patients suffering from pulmonary tuberculosis are sent to high altitudes. These regions are better suited to early cases, older cases with well marked physical signs do better at low altitudes, especially if hemoptysis is a complication. It is the opinion of Nienhaus of Davos, Switzerland, that non purulent pleuritic exudates which show no tendency to absorption at low levels disappear after a comparatively short stay at a mountain resort, and that pleuritic adhesions are stretched and thinned and thereby healed by means of the involuntary lung gymnastics caused by deeper inspiration. There is the risk that such an increase in respiratory movements may produce emphysema and cause a spread of the disease. At Leysin, Switzerland, where the climate is characterized by relatively long periods of solar radiation at a high altitude, Rollier has secured excellent results with heliotherapy in tuberculous infections of the bones, joints, glands, and peritoneum. Such mountain heliotherapy has also been employed prophylactically in open air schools for delicate children. These children gain weight and thrive in such surroundings. The procedure which Rollier employs has been described in Chapter X.

*Artificial Climate (Air Conditioning)* Air-conditioning as we know it today is a relatively modern development. Fundamentally, it is very old, harking back to the days when prehistoric man built a fire within his cave to keep himself warm. Americans are said to hold the temperature of their homes at too high a level, as compared, for example, with people living in England. The occurrence of upper respiratory tract infections in the winter may be due to the sudden changes in temperature and humidity to which the respiratory mucosa is exposed in going in and out of dry, heated rooms on cold moist days. I have observed a relative humidity of between 20 to 30 per cent in heated apartments in New York City during the winter time. Such a low humidity has a drying effect on the upper respiratory tract. It is possible that elevation and maintenance of the humidity at between 40 and 50 per cent diminishes the incidence of colds. Special, relatively simple apparatus is available for increasing the moisture content of dry air within homes.

Although artificial cooling of the air has brought comfort to persons who find it necessary to live and work in warm surroundings, it is not an un-mixed blessing, because the sharp differences in temperature and humidity between the outdoors and indoors may cause exacerbations of upper respiratory tract and rheumatic disorders. A possible solution of this difficulty, suggested by Ferree, lies in dehydrating the air to a low humidity without reducing the temperature more than a few degrees below that of the level out-

chance of being drowned." Marine climates are recommended for persons with hay fever, chronic laryngitis, and chronic bronchitis. They may also be of value following convalescence and for some forms of nervous disorders. The worried and overworked individual who is looking for rest and tranquillity should avoid cruises on which there is much social activity.

*The Seashore.* A stay on the seacoast in a climate characterized by relatively warm temperature is advised for respiratory infections, dry bronchial catarrh, and the bronchial affections of older persons. Children who react well derive much benefit from a stay at the seashore; those who do not respond well to sun and ocean air should avoid it. Sea-bathing provides a strong metabolic stimulant through the combination of natural chloride mineral water, exposure to wind and fresh air, to the sun's rays, and to the mechanical action of the water. Sir Henry Gauvain has made good use of sea-bathing in the treatment of children suffering from non-pulmonary tuberculosis. Under his regime the child is acclimatized through gradual exposure, and then permitted to play around in the water. Not until after some days, when the patient's reaction is good, is total immersion allowed. Children who cannot walk are carried on stretchers and dipped into the sea. Paddling or spraying is not allowed until the temperature of the water reaches 58° F.; when it exceeds 60° F. total immersion is permitted. He considers that the optimum temperature for sea-bathing is between 65° and 68° F.; that the rising tide is to be preferred because it is fresher; that the best time for bathing is from two to three hours after breakfast. After the bath, the child is wrapped in a warm bath towel and dried before a small fire on the beach. His feet are placed in hot water and he is given a warm drink. It has been noted by Gauvain that with the increase in metabolism, the muscular tone is improved; recalcification is stimulated; glands are more rapidly absorbed; and after an initial increase in discharge, there is rapid healing of sinuses (unless they are kept open by dead sequestra). Haberlin recommends the climatic sea cure for patients suffering from upper respiratory infections including asthma, exudative skin diseases, food allergies in children, functional disorders of the gastro-intestinal tract, and functional disturbances of the heart.

*High Altitudes.* According to Ray, the patients most suitable for treatment at high altitudes are persons possessing plenty of muscular energy and strong bodily constitutions, who have become mentally exhausted by business or domestic worries and anxieties and who have perhaps indulged too much in the pleasures of the table. The initial discomfort experienced when first coming to high altitudes, such as dyspnea, palpitation, nausea, and tinnitus,

paratus applied to the mouth and nose Weiss has described the use of such pneumatic treatment The inhalation and exhalation of air below atmospheric pressure through the use of rarefied air is said to be helpful in the treatment of bronchial and cardiac asthma The inhalation and exhalation of air above atmospheric pressure is stated to be of value in the care of asthma, chronic bronchitis with dyspnea, and when abundant expectoration of mucus is desired The two techniques, namely, those of overpressure and underpressure, may be combined In spas abroad, inhalation therapy is frequently administered for the treatment of upper respiratory diseases such as rhinitis, laryngitis, tracheitis, pharyngitis, and tonsillitis Such inhalatoriums employ vaporized and nebulized mineral waters as well as combinations of salts, oils, and other medicaments

*Ionized Air* Electrical charges in the atmosphere vary in different localities both as to number and sign On mountain tops and on sunny days, for example, there is an increase in the number of negatively charged ions, whereas at the seashore and on cloudy days the number of positive ions is increased The electrical content of the air has been artificially altered by apparatus constructed for the purpose Happich believes that a definite improvement and even cure may be obtained in such chronic diseases as bronchial asthma, rheumatic affections, and endocrine disorders Hoppel and Strasburger maintain that patients suffering from hypertension and rheumatic affections have improved under this treatment

#### SPA THERAPY

The Council of the International Society of Medical Hydrology has defined a spa as follows "A spa is a place where there occur mineral waters or natural deposits of medicinal value, where the local administration has provided suitable facilities for making use of these and where the treatments are given under medical direction" The requirements for admission to the Federation of British Spas is in accord with this definition These requirements are

- 1 Possession of natural mineral waters which possess a definite therapeutic value
- 2 Existence of sufficient bathing and pump room accommodation
- 3 Residence in the particular town of medical men who specialize in spa treatment
- 4 Suitable hotel and boarding house accommodation
- 5 Treatment must be given under the direction of properly qualified medical men

doors. Linke believes that general installation of air-conditioning in living quarters and offices in moderate climates is injurious, and that the greatest danger lies in the curtailment of the activities of the regulating systems of the organism.

There are definite indications for the therapeutic use of air-conditioning. Some sufferers from asthma and hay fever, for example, may be relieved while they remain in air-conditioned atmospheres freed from the offending allergens. The postoperative care of patients in the tropics or during northern summers can be improved by air-conditioning. In the care of otherwise healthy infants in the tropics, the use of a room in which the temperature and humidity are controlled may have life-saving value (Carles). Lowering the temperature in operating rooms is of value to both patient and surgeon. Ferderber suggests that such rooms be held at a dry bulb temperature between 72° and 74° F., with a relative humidity of 50 to 60 per cent. Keys recommends a dry bulb temperature between 70° and 80° F., with a relative humidity between 40 and 50 per cent. Filtered air reduces the possibility of wound infections, while humidity as high as 50 per cent diminishes the dangers of explosive anesthetics. Keys recommends that the temperature of nurseries be not lower than 75° F. nor higher than 95° F., except for premature infants, when it may be as high as 98° F. Ferderber found that with dry bulb temperatures between 77° and 100° F. and a relative humidity of 65 per cent, the physiological weight loss of premature infants in the first four days of life was reduced to 6 per cent of the birth weight as contrasted with 12.4 per cent in an ordinary nursery. He suggests that a dry bulb temperature of 65° F. and 50 per cent relative humidity are the optimum conditions for an oxygen tent when the oxygen concentration is 50 per cent or more.

*Pneumatic Chambers.* In Europe, use has been made of special chambers in which atmospheric factors can be varied. The size of these chambers varies from that of a telephone booth to that of a large room. Within them, the air pressure may be changed to a level higher or lower than that of the outside atmosphere; it can be filtered to remove substances found outdoors; it can also be modified by the addition of vapors, electrically charged particles, and the like. Patients suffering from bronchitis, asthma, emphysema, and upper respiratory tract infections may be treated in pneumatic chambers. The initial treatment may be for a period of one hour; this is gradually increased to two hours. Twenty or thirty such treatments may be administered on successive days.

*Inhalation Therapy.* The pressure of respired air can be changed by ap-

## CLASSIFICATION OF MINERAL WATERS

Spa waters contain a variety of cations and anions, but there is usually a preponderance of one which serves as a basis for classification. Smith says that "as a matter of expediency it is good to hold to the position that a full knowledge of the composition of water as at present available, does reveal the basis of its medicinal value and to depart from this position only when the evidence of experience suggesting a different conclusion is strongly convincing." However, the manner in which minerals and gases are held within natural water may account for a therapeutic effectiveness which cannot be explained on a purely chemical basis. Spa treatments are generally prescribed on the basis of clinical experience. Attempts at artificial incorporation into water of the ingredients contained within mineral springs have not proved effective. Natural mineral waters bottled at the spa and artificial waters are used for home treatment. So also are "salts," either extracted from natural mineral waters at the source or produced artificially. Neither of these have the therapeutic influence of the natural products as ingested at the spa. They usually lack the trace minerals present in the natural mineral waters.

*Saline or Muriated Waters* Common salt is the chief ingredient of saline or muriated waters. In addition, they may contain chlorides of ammonium, barium, calcium, lithium, magnesium, potassium, and strontium. Free carbonic acid is often present. Waters of this type are found at Glen Springs, New York.

*Alkaline Waters* Alkaline waters are so called because of their predominant content of sodium carbonate and bicarbonate. They may contain bicarbonate and carbonate salts of barium, calcium, iron, lithium, magnesium, and potassium. At Manitou, Colorado, there are alkaline waters.

*Alkaline-Saline Waters* Alkaline-saline waters are mixtures in which there are appreciable quantities of common salt in addition to sodium bicarbonate. At Saratoga Springs, New York, and Richardson Springs, Indiana, there are alkaline saline waters.

*Sulphur or Sulphuretted Waters* The major ingredient of sulphur or sulphuretted waters are the sulphides, thiosulphates, and sulphates of sodium, magnesium, and calcium (Glauber's salt, Epsom salt, gypsum). Waters of this type are found at White Sulphur Springs, West Virginia, and French Lick Springs, Indiana. Sulphated saline waters contain relatively large amounts of sulphates and chlorides which may be those of sodium, potassium, calcium, iron, and lithium. Waters charged with hydrogen sulphide

6. The amenities and sanitary conditions of the town must be duly approved by the Federation.

7. The spa must be under municipal or other approved control.

8. The chief activity of the spa must be the provision of facilities for spa treatment.

In addition to these requirements a spa should provide facilities for the administration of other physical therapeutic measures such as massage and exercise, and for various sports and recreational activities. The climate of the spa and its accessibility are additional considerations. When selecting a spa, not only the specific condition to be treated but the patient as a whole should be taken into account; that is, his mental state and his clinical status—nutrition, the presence of cardiac, gastro-intestinal, renal or other pathological changes. For example, an arthritic patient who also suffers from heart disease, should not be referred to a spa devoted to the treatment of arthritis, which is located in the mountains with its uneven terrain and high altitude, but rather to a spa with relatively flat surroundings. During the time he spends at the spa, the patient should be given specific instructions for his daily activities, including guidance as to diet. His day should be spent in a pleasant as well as a healthful fashion. Such a regime, with its removal from the scenes of stress and worry, change of climate, outdoor life, and adequate periods of sleep, has a beneficial psychic effect which makes him more amenable to therapeutic measures.

There is considerable evidence to prove that spa therapy can also cause organic changes. That the therapeutic effect of spa treatment is not entirely psychic is evident from the fact that animals—race horses, domestic pets such as dogs and cats and even birds—have been treated successfully at spas. It has been argued that it is unlikely that spas exert direct therapeutic action since one type of disease may respond favorably at various spas possessed of different characteristics. One gouty patient, for example, suffering from chronic joint changes may be benefited by the use of sulphur springs and mud baths and packs. Another, with non-articular involvement, while suffering predominantly from hepato-intestinal or renal disorders, should be referred to a spa enjoying a reputation in the treatment of these conditions and not to spas where the care of arthritis is the major concern. Lord Horder believes that spas are of special value because of the attention paid there to minor deviations from normal health, such as occur in rheumatic and functional nervous diseases, and because of the effort made to raise the level of fitness in those who are free from disease.

by ordinary water, which have been described in the chapters on hydrotherapy and on heat and cold. An important difference between mineral and ordinary water is that the neutral zone of water containing carbon dioxide is from 3° to 4° F lower than that of ordinary water. The mechanical effect of mineral water is also that of water except for the influence of changes in specific gravity. This mechanical consideration is of particular interest in the treatment of cardiac patients (page 522).

Application of waters, mud, and peat found at spas produces local, focal, and general reactions. The local reaction occurs at the site of application in the form of marked hyperemia. The focal reaction is evidenced by an increase of pain and swelling at the site of the focus of the disease, whether it be a joint or some other region. It occurs within twenty four hours after the application and terminates within the next twenty four hours. The general reaction has been called the "cure crisis" or "cure reaction." The symptoms are similar to those of protein shock therapy. When baths are taken too frequently or at too high a temperature or for too long a duration, symptoms of exhaustion may be produced.

The clinical effects of spa treatment depend on whether the media are used externally or internally. Externally, such substances as salt and sulphur exert direct astringent and antiseptic action on the skin. The action of mud and peat baths is based on their chemical, temperature, pressure, and other physical effects. Absorption through the skin of the gaseous contents, such as carbon dioxide, radon, hydrogen sulphide, may cause changes in the body tissues. The alterations produced by carbon dioxide effervescent baths are mentioned in the discussion of the use of carbon dioxide baths (page 35).

The internal administration of mineral waters is usually by mouth, although they may be administered through the rectum as in colonic irrigations. They may also be inhaled by means of fine sprays, as in the treatment of chronic catarrhal conditions of the upper respiratory tract. Mineral waters used for such sprays contain the chlorides and bicarbonate salts of sodium or hydrogen sulphide. They are said to exert a solvent and soothing action.

The physiological action of imbibed mineral water is attributed to the ionic dissociation of the minerals held in the water, as well as to the effect of the water itself. As stated by Fitch, "The hydromineral action of a water seems to be due to the constitution of the combination resulting from dissociation of the molecular elements of the water, rather than to its total mineralization." Baudish stated that the minerals contained in these waters exist in structural complexes which differ in form from artificial preparations of the same sort. He suggested that the human organism requires these



gas are referred to as sulphuretted. Hydrogen sulphide is the most active therapeutic agent.

*Earthy Calcareous Waters.* These waters contain salts of the alkaline earths (calcium, magnesium, barium, strontium). The carbonates of calcium and magnesium are the chief ingredients of some of the earthy waters. Others are characterized by a preponderance of sulphate of calcium (gypsum).

*Iron Waters.* Iron water springs contain other mineral salts such as ferrous bicarbonate. To be regarded as iron water, at least 10 milligrams of ferrous or ferric iron per liter of water must be present.

*Neutral or Indifferent Waters.* Examples of these waters are Mountain Valley, Arkansas, and Poland Springs, Maine. They contain relatively small amounts or traces of minerals.

There are springs in which arsenic is found either in association with the sulphate or bicarbonate of iron or with the chloride or bicarbonate of soda. There are also waters in which small quantities of bromine and iodine exist.

Mineral waters may be gaseous or non-gaseous. The gaseous content of springs differs in kind and in quantity. The most important of the gaseous springs are those that contain free carbon dioxide (Saratoga Springs). Others are characterized by the presence of hydrogen sulphide. Radio-active emanations (radon) are contained in all waters, but certain springs are radio-active to an unusual degree. The analysis of the mineral content of waters can be indicated in several ways; in terms of ions of salt components in parts by weight in 100,000 or in terms of grains of solids per gallon or in parts per 100,000.

The temperature of the water of a spring determines whether it is thermal or non-thermal. According to the United States Geological Survey a thermal spring is one the temperature of which is at least 15° F. higher than the mean annual temperature of its locality. Generally, a spring is considered as non-thermal if the temperature of its water is below 70° F., or as thermal if the water temperature is above 70° F. In the United States, the temperatures of thermal springs vary from that of the water of Hot Springs, Virginia, with a temperature of 106° F. to that of Arrowhead, California, with a temperature of 204° F.

#### PHYSIOLOGICAL ACTION

Mineral waters may be isotonic, hypertonic, or hypotonic. They promote elimination through skin, bowels, or kidneys. The changes produced in the human body by these waters are due to thermal, mechanical, and chemical influences. The thermal changes are essentially the same as those produced

tain magnesium Thermal saline waters are used in the treatment of fibrositis and torpid types of eczema

*Sulphate waters* (bitter waters) have laxative and purgative effects, and are extensively bottled for home consumption The properties of sulphates and also of sulphated alkaline waters are utilized in the treatment of obesity These waters enjoy considerable reputation in the care of disturbances of liver function, chronic disorders of the gall bladder and biliary tract, in gastro intestinal catarrh and for the treatment of uric acid gravel

*Saline-alkaline waters*, because of their solvent and expectoration favoring effects, are employed in chronic catarrhal conditions of the respiratory organs Taken in larger amounts, they act as a laxative and are given preferentially to patients of the lean type They are considered useful in organic gastric disease associated with hypochlorhydria

*Sulphated-alkaline waters* prove most salutary in gastric conditions associated with hyperchlorhydria, in hepatic and gastro-intestinal disorders They are prescribed for stout plethoric patients suffering from constipation They are of benefit in the treatment of disorders of the respiratory system and also for uric acid gravel

*Sulphur waters* with, or without hydrogen sulphide are used for their laxative properties and also in patients with hepatic dysfunction and gastro-intestinal catarrh They increase the flow of bile Sulphur waters are of great value in cases of chronic poisoning with heavy metals such as lead and mercury Antisyphilitic treatment with mercury inunctions are still carried out at certain sulphur water spas in Europe

*Earthy waters*, due to their soothing action, are employed in gastric and intestinal catarrhs They prove beneficial in the treatment of bladder catarrh and are given also to patients with uric acid gravel

*Iron waters* are most beneficial in anemias characterized by iron deficiency and in debilitated individuals

*Arsenical waters* are employed in anemia, skin diseases, chorea and Hodgkin's disease

#### DISEASES TREATED AT SPAS

A residence of three or four weeks or more at a spa can prove helpful to patients suffering from a variety of disorders Such patients should be under the care of a spa physician who will give them specific instruction as to the time and quantity of water which they are to drink, the type, frequency, and duration of the baths or packs which they are to take, exact instructions as to what they are to eat, when they are to rest, and the charac-

“mineral-vitamins” as it does the more commonly known vitamins.

It has been suggested that the action of weakly mineralized waters may be due primarily to the effect of the water itself. Water stimulates the production of gastric, biliary, pancreatic, and intestinal secretions. It facilitates the passage of gastric and intestinal contents and so aids in the evacuation of the bowels. It is a diuretic.

The inorganic salts contained in mineral waters exert a physiological action in addition to the osmotic changes for which they are responsible. Hypotonic solutions of sodium chloride act as diuretics; hypertonic solutions act as laxatives and purgatives. In general, carbonated saline and saline-alkaline waters increase gastric secretion. Alkaline and sulphated waters diminish the secretory activity of the gastric mucous membrane; they stimulate the function of the liver, increasing the flow of bile; they exert a diuretic effect, and according to some authorities increase the solvent power of urine for uric acid. Sulphur water has a sedative action; those containing sodium or magnesium sulphate in large quantities act on the intestinal tract, exerting a laxative or cathartic effect. Potassium salts have a diuretic effect whereas sodium salts are solvent and magnesium salts are laxative. Calcareous waters taken in large amounts act as diuretics. The antacid effect of calcium carbonate may also be of use in appropriate cases. Iron acts as a tonic, and as a stimulant to the production of hemoglobin. Waters containing carbon dioxide gas are said to exert a sedative action on both the gastric and arterial systems, when administered cold; when taken warm and when highly charged with sulphuretted hydrogen they are stimulating. Radon-containing waters are stated to increase the metabolism of body cells.

#### THERAPEUTIC INDICATIONS FOR INTERNAL USE OF MINERAL WATERS

*Alkaline waters* are indicated in disturbances of the gastro-intestinal tract (gastric dyspepsia, hyperchlorhydria, flatulence) and in hepatic dysfunction. They are recommended for the treatment of urinary calculi, especially oxalate and urate stones and gravel. Such waters are employed in the treatment of albuminuria of mild degree. They are also administered to patients suffering from eczema.

*Saline waters* are considered helpful in chronic catarrhal conditions of the gastro-intestinal tract (chronic gastritis, hyperacidity, duodenitis), and in functional hepatic disorders. The waters relieve hepatic congestion and stimulate activity of the liver. They are said to be of benefit in lean persons because they enhance digestion and promote anabolic processes. They act as a mild laxative when given in adequate amounts, especially when they con-

lesions of the nervous system are treated, as in other places, with underwater exercises and other forms of physical therapy

*Cardiovascular Disorders* Functional disturbances of the heart, such as neurovascular asthenia, are benefited by therapy, especially by carbon dioxide, brine baths and other forms of balneotherapy, graduated exercise, and so forth Cardiovascular conditions accompanied by mild or moderate decompensation may respond to carbon dioxide (effervescent) baths and other spa measures (pages 35 and 522) Carbon dioxide baths lower arterial tension and slow the heart rate, possibly by stimulation of the vagus The usual hot bath does not slow the heart rate in the same manner It has been pointed out (page 37) that carbon dioxide baths are the only form of physical therapy in which the cardiac muscle is trained without concomitant increase of the pulse rate In disorders of rhythm such as sinus tachycardia and tachycardia of hyperthyroidism, these baths have a sedative effect Patients who suffer from congestive heart failure, advanced luetic heart disease, severe dyspnea, and febrile endocarditis are not suitable subjects for spa treatment Functional hypertension is frequently helped by carbon dioxide baths, exercise, massage, and similar measures Hypertension due to arteriosclerotic changes may not be materially benefited

*Respiratory Diseases* Spas specializing in the treatment of respiratory disorders are equipped with special apparatus for the administration of sprays, douches, and gargles, and with inhalation rooms where nebulized mineral waters of the alkaline-chloride type or with other added substances are inhaled under normal or altered atmospheric pressures Internal consumption of mineral water is considered to play an important part in the treatment through its effect on the associated metabolic or gastro intestinal disturbances Respiratory conditions suitable for spa therapy include chronic sinusitis, chronic pharyngitis, bronchitis, and asthma The favorable effect exerted by some sulphur waters on catarrhal conditions of the upper respiratory tract is explained by the fact that these waters are partially eliminated through the bronchial mucous membrane

*Gastro intestinal Disorders* Sulphated, alkaline waters are prescribed for chronic catarrhal conditions of the stomach and intestine in which there is excessive secretion and hyperacidity Alkaline saline waters are recommended in the presence of diminished secretions and hypo-acidity The person accustomed to eating and drinking too well may secure relief from his "dyspepsia" by following a spa regime including the ingestion of alkaline waters containing carbonic acid For patients suffering from functional gastro-in-

ter and frequency of their exercise, and of the other physical therapeutic treatments which they are to receive. If necessary, the patient is taught how to conduct himself after he has returned home from the spa so as to live as well as he can with his illness.

*Diseases of the Locomotor System.* Sufferers from rheumatic affections form a large percentage of those who seek relief at spas. This form of therapy is indicated in both the articular and non-articular conditions. Fibrositis in the acute or subacute stage should be treated at home; in the chronic stage, spa treatment may so influence the metabolic background that the local manifestations yield to physical therapeutic procedures. Hot vapor or steam baths from thermal mineral springs, administered in special rooms or cabinets, are useful in the treatment of fibrositis and arthritis. In persistent rheumatic disorders baths containing sulphur, administered at high temperatures, may give relief. Brine baths, and mud and peat baths and packs which cover the entire body or parts of it, are of value in the treatment of rheumatic, gouty, and traumatic exudates. The sequelae of traumatic injuries, chronic indurated wounds, and osteomyelitis may be benefited by chloride or brine baths. Spa therapy is of value in the care of both osteoarthritis and rheumatoid arthritis. The fact that arthritic patients return year after year to spas indicates that while the treatment does not cure the disease, it affords a greater measure of relief than they are able to obtain at home.

In the subacute and chronic stages of gout, alkaline waters containing the carbonates or bicarbonates of lithium, potassium, sodium, magnesium, and calcium are given internally. Hot sulphur baths and hot mud baths or packs comprise the local treatment. Some patients are more comfortable in a sedative climate; others do well in a bracing climate.

*Neurological Disorders (Functional Nervous Disorders).* A properly equipped spa is particularly suitable for the care of persons suffering from real or imaginary symptoms due to mental tension caused by anxieties, overwork, and the like. Complaints of fatigue, insomnia, and headache may disappear after a few weeks' vacation at a restful resort. Removal from home surroundings, exercise, sports, supervised diets, inauguration of regular habits including those of the bowels, plenty of sleep, warm baths, in addition to the psychic factors, all help to bring about relief of these symptoms. Frankly psychotic patients should not be sent to spas.

For the treatment of neuritis, including sciatica, simple thermal baths, warm sulphated baths and hot mud baths and packs are employed. Organic

forma Most of the European resorts are public institutions The natural scenic beauty of their surroundings is enhanced by carefully planned architectural features, and entertainment is furnished to help the visitor spend his time pleasantly but not excitingly

Appreciation of the possibilities of spa therapy is more general among the European medical profession Competent specialists are familiar with the therapeutic possibilities and the methods of applying them The experience of European resorts in solving the administrative, medical, and social difficulties might be used profitably in establishing American spas In 1937, as president of the American Congress of Physical Therapy, I appointed a special committee to assemble data concerning spa and health resorts of this country The following year, a committee on health resorts was appointed by the American Medical Association The data secured by these and other groups should serve to make the use of spas more general in this country Many of the large number of mineral springs in the United States are described by Fitch in "Mineral Waters of the United States and American Spas" The waters are as efficacious as those found in Europe, in some instances they are superior A few of the leading spas in this country are described in the following pages

*Arrowhead Hot Springs, California*, is situated in a valley at the foot of Arrowhead Mountain, at an elevation of 2000 feet above sea level The water of Penyuqal Hot Springs is believed to be the hottest of any curative spring or spa in the world— $202.2^{\circ}$  F This spring contains disodium arsenate, a very rare ingredient in mineral waters The only other springs in the world which contain this valuable mineral constituent are those at La Barboule, France The waters of Arrowhead are moderately mineralized, sodium, sulphated, calcium, bicarbonated, alkaline saline (arsenated) waters, possessing diuretic, antacid, laxative, and alterative properties They are valuable for conditions of the gastro intestinal tract, liver, kidneys, and general debility The steam caves and mud baths are the hottest natural ones in the world The former are roomlike cavities in the conglomerate strata, which are filled with natural steam issuing from the rocks, the temperature varying from  $158^{\circ}$  to  $200^{\circ}$  F They are used for the treatment of lumbago, rheumatism, sciatica, and neuritis

*French Lick Springs French Lick, Indiana* derives its name from the time when it was a French trading post The waters are of the sulphated saline type, containing sodium and magnesium They are also carbonated, sulphated, and radio activated Their laxative, diuretic, antacid effect is beneficial in diseases of the stomach, intestines, liver, gall bladder, blood and

testinal disturbances, the change in habits of eating and exercise, removal from the worries at home, the soothing influences of baths, help to restore normal function. Sulphated alkaline mineral waters are of special value in the treatment of chronic constipation because they stimulate the secretion of bile. For the same reason they are of value in the care of chronic disorders of the gall bladder and biliary tract. Sulphated waters are laxative and purgative. Taken warm, they have been recommended for chronic hyperemia of the liver due to overeating, alcoholism, and a sedentary existence. Organic diseases of the liver should not be treated at spas.

*Genito-urinary Disorders.* The diuretic action of mineral waters is the basis of their usefulness in chronic cystitis and chronic pyelitis. Sulphated, bicarbonated calcium waters have a marked diuretic action. The drinking of such waters is also advised in the treatment of renal calculi, not because of the possibility of dissolving such concretions but rather to flush small calculi capable of being passed. In nephritis, a mineral water regime may be contraindicated if the condition calls for diminution rather than increase in fluid intake.

*Other Diseases.* When sulphur baths are indicated in the treatment of eczema, prurigo, and staphylococcus infections, the best results are obtained from an alkaline water with a relatively high content of dihydrogen sulphide. Waters containing iron are recommended for secondary anemia. Obesity is a disease in which spa care may be of value (sulphated-alkaline waters). Patients suffering from so-called functional debility after prolonged and wasting illnesses or as a result of overwork and mental strain, inadequate exercise, dietary indiscretion, and the like are frequently materially benefited by spa care.

#### AMERICAN SPAS

The basic physical facilities for spa therapy exist in as great measure in America as in any other part of the world. Every variety of mineral water is found on this continent. Yet, in comparison with European custom, the use to which these facilities are put is meager. Unlike the European, the American is not spa-conscious although many thousands of citizens of this country have gone abroad to receive spa care. The seashore might well be utilized for the establishment of spas. Seashore spas exist in Europe. Patients suffering from arthritis and rheumatic conditions resort to European spas of this type, where, under competent medical direction, advantage is taken of the climate, the use of sea water, sand, and so forth. Seashore spas could be established in regions of the United States, such as Florida and Cali-

similar to those at Aix les Bains in France. The climate is agreeable, stimulating and invigorating. These springs are well equipped for the administration of physical therapy treatments and for all types of sports.

*White Sulphur Springs, Sharon Springs, New York* is located between the Adirondack and Catskill Mountains of New York, at an elevation of 1100 feet above sea level. Sulphur tub baths are given for acute, subacute, and chronic rheumatism, neuritis, sciatica, neuralgia, neurasthenia, and some forms of skin diseases, especially eczema. The waters are applied as external douches in the local treatment of joints, sciatica, and other neuralgic disorders, and as vaginal douches and colonic irrigations. Full steam sulphur massages are given for subacute and chronic affections of the muscles and joints. The inhalatorium provides for the inhalation of vaporized sulphur water to which pine needle extract has been added. These inhalations have proved efficacious in catarrhal conditions of the respiratory system—nasal, pharyngeal, laryngeal, and bronchial conditions. The Nauheim bath is used as an adjunct to the sulphur water treatment. The water may also be taken internally as a drinking cure.

*White Sulphur Springs, West Virginia*, is situated in a valley in the west foothills of the Allegheny Mountains at an elevation of 1400 feet above sea level. The climate is dry, bracing, and invigorating. The waters are radioactive. Water from White Sulphur Springs has been used and prescribed by physicians since 1778. One spring is a chalybeate spring, containing iron in an assimilable form. The alum spring is actively astringent. White Sulphur Springs water is natural sulphur water in a concentrated form, and is generally taken as a laxative and eliminant. The diseases which are benefited by a course of supervised routine, including Nauheim baths and graduated exercises, include constipation, gout, chronic rheumatic conditions, early kidney disorders, high blood pressure, and heart disease, such as irritable hearts and those in the early stages of decompensation. There is suitable and competent medical supervision. The accommodations are comfortable. It is well equipped with various forms of physical therapy apparatus.

#### REFERENCES

- BACMEISTER. Fundamentals of medical climatology *Balneologie*, 4 449-454, 1937
- CARLES, L. M. Prophylactic and therapeutic indications in meteoropathology *Presse méd* 46 1339-1340, 1938
- FERDERBER, M. B., and HOUGHTON, F. C. Effective temperature scale *JAMA* 116 474-477, 1941
- FERREE, J. W. Summer air conditioning *J Indiana M A*, 33 295-297, 1940



blood vessels, urinary system and in nutritional disorders, rheumatism, and obesity. The springs are situated in a valley about 500 feet above sea level.

*Hot Springs National Park, Hot Springs, Arkansas*, was according to legend known to Ponce de Leon and De Soto. These springs are now owned by the Federal Government and conducted under regulations made by the Secretary of the Interior. The waters are classified as thermal, alkaline waters containing the bicarbonate of calcium, sodium, and magnesium; the quantities of the mineral constituents is small. The spa is located in a valley at the base of Hot Springs Mountain, 600 feet above sea level. Originally a summer resort, it has come to be used all year around. The hot waters are employed to give relief in rheumatic and gouty conditions, neuralgia, neuritis, many chronic skin diseases, and some forms of cardiovascular disease with high blood pressure. Its hot baths are used in syphilis.

*Mt. Clemens Mineral Springs, Macomb County, Michigan*, is located on Lake St. Clair. Analysis shows this to be a very highly mineralized sodium, calcium, magnesium saline (lithium, bromium, iodine) water, sulphuretted, possessing diuretic, laxative, tonic and alterative properties. The waters closely resemble those at Achel-Maunstein in Bavaria. Owing to excessive mineralization, it is necessary to dilute the water for internal use and for bathing. As bathing and drinking cures these waters have acquired considerable reputation in the treatment of scrofulous disorders of the skin, conditions of the bones and joints, rheumatism, chronic articular joint diseases, sciatica, neuritis, gout, uric acid diathesis, neurasthenia and general nervous breakdown, kidney and bladder affections, and constipation.

*Saratoga Springs, Saratoga, New York*, is located in the foothills of the Adirondack Mountains on a plateau 300 feet above sea level. The spa is conducted under the direction of the State government. The waters are similar to those at Bad Kissingen. They are classified as alkaline, saline, carbon-dioxated. Internally, these waters are beneficial for rheumatism, gout, neuritis, dyspepsia, constipation, and various liver and stomach disorders. In the form of baths, they are used for arthritis, neuritis, diseases of the heart, and stomach disorders. The bathing waters here are more abundant and more highly saturated with carbon dioxide gas than are the waters at any of the European spas.

*Virginia Hot Springs* is situated in a valley in the Appalachian Mountains. The waters are classified as moderately mineralized, thermic, calcium, magnesium, bicarbonated and sulphated alkaline waters, carbondioxated and strongly radio-activated. They are efficacious in the treatment of gout, rheumatism, obesity, neurasthenia, in disturbances of the gastro-intestinal tract characterized by hyperacidity, and in diseases of the liver. The waters are

## CHAPTER IV

# VISIBLE AND INFRA-RED RADIATION

THE OLDEST AND MOST COMMONLY USED FORMS OF heat are those derived from visible and infra-red radiation. Radiation from the sun owes its effects not only to its ultraviolet content but also to its visible and infra-red energies. The two latter attributes provide most of the total energy falling upon the surface of the earth. The ultraviolet component comprises less than 1 per cent of the total radiation from the sun.

In addition to the sun's rays, which have been employed purposefully or inadvertently by man for maintenance of his well-being and for treatment in disease, heat from other sources has been universally used for therapeutic purposes since time immemorial. Thus heat has been administered by means of hot water, hot sand, poultices, heated bricks, hot water bottles, wood and coal fires, gas stoves, and more recently by steam radiators and electric heating pads. All these sources produce infra-red radiation. The human body itself emits infra-red radiation.

This radiation has its inception in the changes of the energy levels within the atoms. When the temperature of a substance is increased, it radiates more energy in the form of "electromagnetic waves," with resultant changes in the wavelength of these waves.

The radiations from metal heated to temperatures between about 100 to 500° C are of long wavelengths, and the human body perceives them as heat. With continued elevation of temperature, smaller wavelengths are added progressively and at about 1000° C the human retina perceives them as red light. At higher temperatures, still shorter wavelengths are added, and the heated metal appears successively as orange, yellow, and white. At this latter stage the metal is "white hot." Elevation of the temperature beyond 3000° C produces wavelengths too short to be perceived by the human eye. These have been called "ultraviolet" waves, because they are beyond the violet end of the visible spectrum. They were first discovered in 1801 by Johann Ritter, who noted the changes which they produced on silver chloride. In the previous

- FINN, R. S. In Blumer: The Therapeutics of Internal Diseases. New York, Appleton-Century, 1940, Vol. I, Chap. 2.
- FITCH, W. E. Mineral Waters of the United States and American Spas. Philadelphia, Lea and Febiger, 1927.
- GAUVAIN, (SIR) HENRY. The Effect of Sun, Sea, and Open-Air Treatment. London, Medical Research Committee, H. M. Stationery Office, 1919.
- HAPPICH, C. Air electricity and clinical therapy: facts and prospects. *Deutsche med. Wchnschr.*, 64 : 665-668, 1938.
- HILL, L. The Science of Ventilation and Open-Air Treatment. London, Medical Research Committee, H. M. Stationery Office, 1919.
- HORDER (LORD). Value of spas in raising the standard of health. *M. Rec.* 148 : 128-129, 1938.
- LINKE, F. Basic premises of light climatology. *Fund. Radiol.*, 4 : 29-32, 1939.
- MACLEOD, J. J. R. Physiology and Biochemistry in Modern Medicine. St. Louis, Mosby, 1926.
- MILLS, C. A. Medical aspects of climatology. In Principles and Practice of Physical Therapy. Hagerstown, Maryland, Prior, 1932, Vol. I, Chap. 24.
- POTTENGER, F. M. Living with weather. *Ann. Int. Med.*, 14 : 502-512, 1940.
- RAY, M. B. Hydrotherapy and Climatotherapy. London, E. Arnold, 1936.
- SINGER, C. The application of climatotherapy in general medicine. *Arch. Phys. Therapy*, 20 : 595, 1941.
- SMITH, E. E. Classification of mineral waters. In Fitch, W. E.: Mineral Waters of the United States and American Spas. Philadelphia, Lea and Febiger, 1927.
- SMITH, E. M. In Blumer: The Therapeutics of Internal Diseases. New York, Appleton-Century, 1940.
- WEISS, M. Inhalation and pneumatic treatments. *New York State J. Med.*, 38 : 713-716, 1938.
- YEO, B. The Therapeutics of Mineral Springs and Climates. Chicago, W. T. Keener, 1904.

## TUNGSTEN FILAMENT LAMPS

Deserving of extensive use in the physician's office and in the hospital is the tungsten filament lamp which is comparatively richer in visible radiation and emits a far whiter light because of the metal used in it (Fig 45) It



FIG 45 Fifteen hundred watt tungsten filament lamp with wire mesh screen Insert shows infra red element which can be substituted for the bulb

contains a larger percentage of visible and near infra red radiation than does the carbon filament lamp The wattage used in these lamps varies from 250 to 1500 The large bulbs require a large reflector Because the stands which hold these lamps tend to be top heavy, the base should be wide and supplied with good sized casters to permit easy movement

## INFRA RED GENERATORS

Apparatus that are richer in the long infra red radiations have heating sources made of materials with high resistance, such as iron and German

tion. The carbon filament lamp (which has been superseded by the tungsten filament lamp for illuminating purposes) placed in a reflector is widely used as a heating source (Fig. 44). Its wattage is usually 260. The lamp together

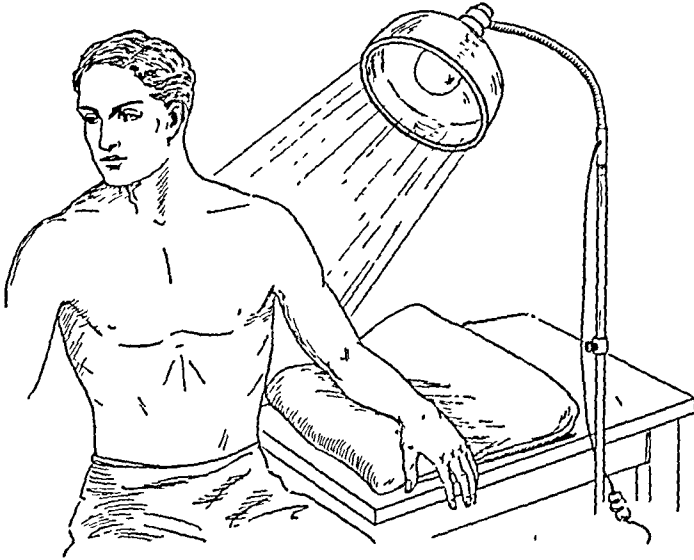

FIG. 44. Small carbon filament lamp.

with the reflector in which it is housed is held in position by stands of various shapes and lengths so arranged that they may be clamped on chairs, or placed on tables or on the floor. Floor stands are the most convenient, because they allow the lamp to be correctly placed without the assistance of some article of furniture. A good reflector permits the rays to leave it parallel to each other. If the reflector is poorly constructed or misshapen there is danger that the rays may focus at one point, which will then become uncomfortably, if not dangerously hot, while the region surrounding it may be warmed comparatively ineffectually.

#### CARBON FILAMENT LAMPS

The carbon filament lamp, modest though its appearance and price, lowly though its position (from a medical practitioner's point of view because it is offered for sale to the layman by druggist, hardware and department stores), is none the less an extremely useful instrument. It deserves a place in every doctor's office, in every hospital, and for that matter in every home, because of the numerous conditions in which it may be of service. The light coming from this lamp is yellow in color because the rays of the red end of the visible spectrum preponderate in it. It also emits near infra-red (up to 14,000 Å) and some far infra-red rays (longer than 14,000 Å).

of the blood stream, the heating effect is mild. Most of the *far* infra-red radiation is absorbed in the epidermis, and therefore it has very little penetrating power. The blood stream and the air serve to cool the epidermis. Anderson's

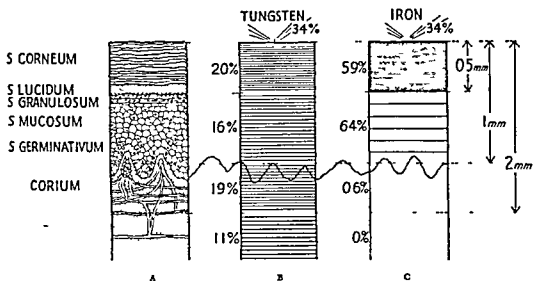

FIG 46 Absorption of radiation from a tungsten source (comparatively rich in visible and near infra red radiation) and from an iron source (containing mainly long infra red radiation) A Schematic section of skin B Reflection and absorption from tungsten source C. Reflection and absorption from iron source Thirty four per cent of the radiation from both sources is reflected from the skin surfaces (Schematic after W T Anderson Jr)

studies give additional confirmation of the fact that radiation from non luminous or poorly luminous heating sources is absorbed almost entirely in the upper layers of the skin, whereas the luminous radiations pass through the skin and well into the subcutaneous tissues (Fig 46). Laurens states that the luminous rays, particularly the red and yellow, are capable of passing through several centimeters of the human body. This carries them well through the dermis, inasmuch as in most parts of the body the skin thickness is between 1.7 and 2.4 mm.

Using thermocouples, I determined the temperature of the surface of the skin and of the subcutaneous area during radiation by these two types of photothermal sources. My findings were in agreement with those mentioned and with others, that is, they showed that lamps emitting the larger percentages of visible or near infra red radiation were decidedly more effective in elevating the subcutaneous temperature than those containing mainly infra red rays. An ordinary electric bathroom heater was more effective than an infra red lamp in creating elevations of subcutaneous temperature. The temperature of the surface of the skin was higher when the infra red lamps were applied to the tolerance point than when the more visible sources were

silver. Most of these instruments glow a dull red because their radiation is largely in the infra-red field. This type of apparatus has been advertised as possessing very special therapeutic merits. Except for its reflector, the ordinary electric heater sold in hardware and drug stores for a small sum is just as efficient as most of these so-called infra-red generators. Some of them have been advertised under special names. This further tends to confuse the physician who has not paid special attention to the subject and therefore does not readily identify the apparatus for what it really is, an electric heater.

Infra-red radiation of the longer wavelengths has a place in therapy. There are occasions when it is to be preferred, because its effect is skin deep and therefore more effective as a counterirritant. In subacromial bursitis, for example, when the inflammation is subacute, penetrating heating energies may aggravate the condition, whereas relatively non-penetrating energies may be of value.

#### ARC LAMPS

Many of the lamps used for their ultraviolet radiation also emit visible and infra-red radiation; in this respect they resemble solar radiation more closely than any of the other artificial sources of ultraviolet. The hot quartz mercury vapor lamps produce a considerable quantity of infra-red rays as well as visible energy at the violet end of the spectrum. These visible rays give the light its peculiar color. This type of colored light is also associated with the so-called "cold" ultraviolet generators. The amount of infra-red radiation coming from these lamps is comparatively small.

#### PENETRATION OF VISIBLE AND INFRA-RED RADIATION

The penetrating quality of the radiation from luminous sources may be readily appreciated when one observes transillumination of the paranasal sinuses. The visible rays which pass through the tissues from a light source placed in the mouth and which can be seen by the examiner's eye, cause no changes in the structures which they traverse. According to Grothus' Law only rays which are absorbed by the tissues will cause heat within them. Bachem and Reed showed clearly that the energy in the lower end of the visible and the *near* infra-red portion of the spectrum penetrates the skin with a considerable percentage of the energy passing into the subcutaneous area. These authors state that the blood in the corium and the subcutaneous layers absorbs most of the visible and near infra-red radiation. Because of the small absorption in the epidermis and the convective cooling

blood carries much of the heat away by conduction. In spite of this, the local temperature becomes elevated with a consequent increase in the local metabolism. The active hyperemia is associated with vasodilatation, and the consequent changes in the pressure relationships between arterial and venous circulation and cellular and intercellular fluids. These and other physiological changes produced by heat are discussed in Chapter I.

Sweating may occur in the heated area or, if the degree of warmth on the surface is sufficiently high, the sweat may evaporate and not be readily noticeable. An almost immediate response is an erythema which becomes more intense as the radiation continues. This erythema may be mottled in its appearance, "erythema ab igne." Frequently repeated exposures can produce mottled pigmentation. The local metabolic activity is increased as is the local tissue immunity. The number of white corpuscles in the region may be augmented, phagocytosis becomes more active. Clinically, infra red radiation has a sedative and antispasmodic action. Relaxation may be explained by the counterirritation which occurs as a response of the cutaneous vessels to the thermal irritation. This holds true for other forms of irritation and may possibly be explained on the basis of the production of some histamine-like substance, as suggested by Sir Thomas Lewis. The reflex influence on internal structures when changes are produced on the surface of the body have been described by Krogh and others. It may well account for the sedative influence of infra red radiation on symptoms caused by disturbances of internal organs, although there may be no direct effect on these organs as a result of such radiation.

Clausen found that daily ten minute exposures to near infra red radiation stimulated growth in rachitic rats, and prolonged their period of survival on a ricket producing diet. She noted that infra red radiation given in conjunction with ultraviolet radiation also stimulated growth to some extent in rats fed on a standard ricket producing diet. In experiments conducted by Ludwig and von Reis, the weight of rats grown under visible red rays was 80 grams greater than that of the controls.

#### TECHNIQUE OF VISIBLE AND INFRA RED RADIATION

As with other forms of heat application, the chief guide to maximum dosage of thermal radiation is the tolerance of the patient. It is well to keep in mind that the maximum dosage is not necessarily the optimum one. This is particularly true in cases in which the local vascular changes are abnormal, as in peripheral vascular disease, and in certain other conditions. For example, in the treatment of an infection occurring in the forearm of



used to cause the same heat sensation. This may be due to the fact that the total volume of heat within the skin and subcutaneous layers is greater during the application of visible radiation than during radiation from an infra-red source. There is considerable variation in heat tolerance in different parts of the body. The skin of the forehead and of the hands and the feet is able to endure the greatest amount of heat. These same areas reveal the lowest skin surface temperatures when the point of maximum heat tolerance is reached.

The heating source employed in these experiments was a 260 watt, carbon filament lamp which was held at a fixed distance of 18 inches from the skin surface. The length of time of exposure which the subject could tolerate was the variable factor. The coincident occurrence of greater heat tolerance and lower skin surface temperature in some regions may be explained by the fact that these areas possess the most efficient cooling mechanism by virtue of numerous arteriovenous anastomoses, many sweat glands, and large numbers of thermal nerve endings.

#### PHYSIOLOGICAL CHANGES PRODUCED BY VISIBLE AND INTRA-RED RADIATION

The physiological response of the body to exposures from sources emitting visible and infra-red radiation is explained by the action of heat. We do not yet know of any specific non-thermal influence. The degree of reaction depends on the intensity, the duration, and the extent of the radiation. A local reaction occurs in the irradiated region. A generalized reaction also takes place, varying from a slight vasodilatation of the skin at the periphery of the extremities to a substantial elevation of the temperature of the entire body (page 177). The initial fall in rectal temperature which sometimes follows application of local and systemic heat may be explained by the body's thermal readjustment in its effort to prevent a rise in its systemic temperature level. The generalized reaction is manifested by an elimination of the normal skin surface temperature gradient from the torso to the ends of the extremities; sweating, with consequent chemical changes; increased metabolism; increased respiratory and pulse rate; lowering of the blood pressure, followed in some instances by a slight rise in the systolic and fall in the diastolic pressure. A drop in the systemic blood pressure is a common response to the application of mild heating energies to the body. It may be caused by increase in the peripheral vascular bed, or, as some authors believe, by lowering of the tone of the sympathetic system.

The local hyperemia produced by infra-red radiation is an active and not a passive one. It brings a larger volume of blood into the heated area. This

long distance from the body, because the superficial layers of the skin (in which the thermal nerve ends are situated) will become very hot. With a carbon filament lamp, the distance may be shorter than that used with an infra red burner. A still shorter distance can be tolerated with a tungsten filament lamp, even though such a lamp be energized by 1500 watts while the carbon filament lamp be powered by only 260 watts. This greater tolerance to the tungsten filament lamp is due (1) to distribution of the heat over a larger surface area because of the larger size of the reflector, and (2) to the small percentage of long infra red radiation, which permits the superficial layers of the skin to remain relatively cooler. As with other forms of radiation, that coming from a photothermal source is subject to the inverse square law, that is, the quantity of radiation varies inversely with the square of the distance from its source (Fig 172). This is a useful rule, although not an absolutely accurate one, because the source is not a point but a relatively large area covering the lamp and the reflector surface. According to this law, if the lamp distance is doubled, the radiation reaching the treated surface is one quarter of the previous intensity. Conversely, if the distance is cut in half, the energy reaching the surface is quadrupled.

#### LAMP ANGULATION

If a lamp is placed so that its rays strike the skin surface at an acute or obtuse angle, the effective intensity of its radiation is less than if the rays were at a right angle to the treated surface. This is in accord with the cosine law, which was first enunciated by Lambert (Fig 173). If the lamp is tilted too much from the vertical, it cools more slowly and will burn out sooner.

#### PROTECTIVE APPARATUS

*Eye Shades* When applying radiant energy to the region of the face, it is advisable to cover the eyes, particularly in persons who are light-sensitive. Goggles such as those usually worn for ultraviolet radiation are unsatisfactory because they cover too large an area. Useful "spectacles" are the ones made of small rectangles of black cloth, arranged in a double layer with a piece of cardboard between (Fig 47). The "bridge" of these spectacles is a piece of string inserted through holes at their inner ends. The "temples" are pieces of string long enough to go around the head and tie behind. A piece of absorbent cotton or gauze is placed between these shields and the eyelids so that a new and clean surface is presented each time the device is used.

*Lamp Screens* Inasmuch as lamps occasionally break, it is advisable to

a young woman who suffered from agranulocytotic angina, continuous application of mild heat from a carbon filament lamp appeared to have but little influence on the condition. When the period of application was changed to one-half hour at two hour intervals, marked improvement took place during the ensuing twenty-four hours. It may have been that the patient's general condition (her leucocyte count was only 300) was a factor in the unsatisfactory local response to the larger quantity of heating. In contrast to this, continuous mild thermal application to a region of cellulitis in an otherwise relatively normal person may be much more satisfactory than interrupted treatment. In the care of erysipelas, the prescription may call for the application of radiation for twenty-four hours daily. For some mild effect the lamp may be prescribed for only fifteen or twenty minutes twice or three times during the day.

The size of the lamp to be used should be determined by the size of the area treated. However, inasmuch as lamps come in more or less standardized sizes, the possible variations are limited. The 1500 watt tungsten filament lamp is a useful apparatus. Its disadvantages are that it requires a relatively large reflector housing with a correspondingly heavy and costly stand and that the ordinary house wiring may be inadequate to supply the large amount of current which it consumes. Electric wires of sufficient size and fused to about 15 amperes are needed to supply the current for these lamps.

If it were possible to determine the exact histological status of the treated tissues, thermal radiation and other forms of heat could be applied in much more exact dosage. Lacking this, the dosage must be based on a clinical sense developed by reason and experience. Inasmuch as the patient's subjective response is a guide to the intensity of the radiation which we apply, it is essential to know that the area treated is not anesthetic nor the site of a pathologically diminished circulation. In such patients, as well as in infants and in persons who are unconscious, the operator may determine the intensity of the radiation coming from a photothermal source by placing his hand at the distance at which the lamp is to be held. Allowance must then be made for the fact that the hand can tolerate much more heat than other parts of the body, and that the operator, unlike the recipient of the energy, is in a state of normal health.

#### LAMP DISTANCE

The distance from the patient at which the lamp is to be placed varies with the character of the apparatus employed. If the lamp produces radiation in which the long infra-red predominates, it should be held at a comparatively

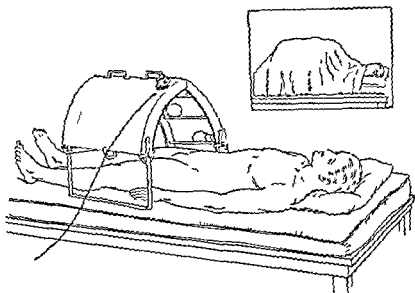

FIG 48 Collapsible heating hood with lamps So called baker

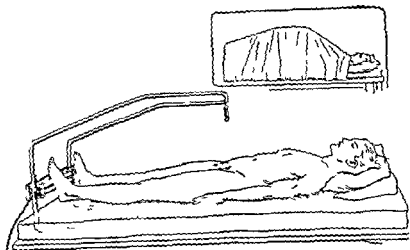

FIG 49 Thermostatically controlled heating hood

protect the opening of the reflector with one of the screens designed for this purpose. These screens do not absorb sufficient radiation to make them objectionable.



FIG. 47. Opaque spectacles to protect eyes against radiation.

#### ELECTRIC LIGHT HOODS AND CABINETS

*Hoods.* Photothermal energy has been applied by numerous devices other than the lamps described. For heating an entire extremity or a considerable part of the body surface, so-called "bakers" have been used for many years (Fig. 48). As these devices are not really employed for baking purposes, the term is a misnomer. The apparatus is supplied with numerous lamps backed by a metallic reflector, and is supported on adjustable legs. All or only a part of the lamps may be lighted at one time. As it creates considerable heating energy, the usual hood may prove dangerous in the treatment of peripheral vascular disease. For the majority of purposes for which electric light hoods have been employed, I have found a thermostatically controlled one more satisfactory (Fig. 49). This hood can be placed over the patient without occupying any space on the surface of the bed. It consists of a tubular ellipse, bent into the shape of a U. The lower portion of the U is inserted under the mattress; the upper portion is rigidly constructed so that a blanket may be drawn securely over it. Thermostatic control is essential to prevent the hood from becoming too hot. Since the temperature of the interior of the hood can be regulated with a fair degree of accuracy it is possible to prescribe the quantity of heating energy with far greater nicety of dosage than is possible with the ordinary hood. Accuracy in dosage

after contusions, sprains, traumatic peri-arthritis, synovitis and tenosynovitis, and fractures and dislocations It is useful in the treatment of myositis, fibrositis, and arthritis (both atrophic and hypertrophic) Its sedative action

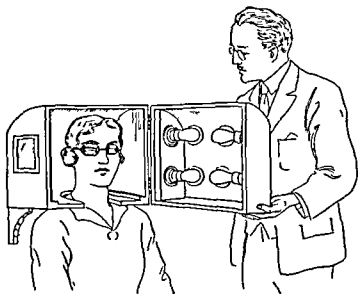

FIG 51 Head light bath

is an aid in relieving pain due to nerve irritation in conditions such as neuritis and neuralgia Its antispasmodic action is utilized in the treatment of cramps arising from intestinal and uterine disturbances Followed by massage and exercise it relieves spastic muscles, such as those responsible for painful feet and for backache Similarly, it helps to relax contractures secondary to central nervous system damage or to other causes

Phototherapy also has a place in the treatment of local infections, but in these conditions its application must be guided by surgical judgment In the very early stages it may help to abort an infection When pus has formed, it must be evacuated by an incision After drainage has been established, photothermal radiation will usually cause pus and serum to drain from an open wound as though unseen fingers were squeezing the area The idea of applying heat to cause a localized infection to "point" is an old one, as witness the common application of hot compresses, flaxseed and other poultices for this purpose

Photothermal radiation may be applied to the head in the treatment of paranasal sinusitis A device used in Europe for this purpose is the "head-light bath" (Fig 51) In this country recourse is more commonly had to a lamp such as the 1500 watt tungsten filament lamp Both the acute and chronic stages of paranasal sinusitis may be benefited by phototherapy If

is especially important when treating diseases of the peripheral circulation of the lower extremities for which the apparatus was especially designed.

*Cabinets.* The electric light cabinet is frequently found in hydrotherapeutic

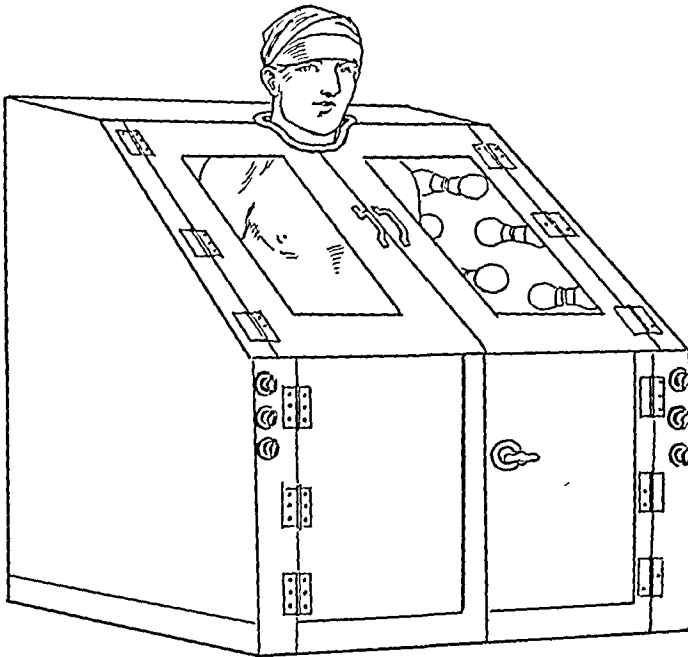

FIG. 50. Electric light cabinet.

establishments, as it is commonly used in conjunction with the Scotch douche in the administration of so-called "neurovascular training" (Fig. 50). If the cabinet is so constructed that a patient may lie horizontally within it, it can be used for the therapeutic production of fever. Most cabinets are built so that the occupant sits on a stool. They are provided with either carbon filament or tungsten filament lamps. Applied for from ten to fifteen minutes the carbon filament lamps are useful to produce sweating in the treatment of skin diseases. For so-called general tonic effects tungsten filament lamps may be applied for from five to eight minutes. As the difference between the effects of the carbon filament and the tungsten filament lamps is slight when they are employed in this manner either one may be used on most occasions.

#### INDICATIONS FOR VISIBLE AND INFRA-RED RADIATION

Phototherapy is utilized for its hyperemia-producing and pain- and spasm-relieving effects, and also as a preliminary to and in conjunction with massage and exercise. Its direct and indirect effects on local areas make it valuable in the treatment of injuries to soft tissues, such as those occurring

has also been found advantageous in the care of lupus erythematosus Vollmer pointed out that the beneficial effect may be due to exclusion of the more chemically active rays and not to a specific influence of the red light. The preference shown by guppies for blue light and by ants for red light results from the natural preference of certain animals for light, darkness, and semi-darkness. Some colors may exert a psychic effect and have, therefore, an indirect therapeutic influence. It has not been proved that the various colors of the visible spectrum exert any direct therapeutic effect other than that which can be attributed to their physical characteristics. Radiation from infra-red lamps, for example, is comparatively rich in the lower end of the visible spectrum and the near infra-red rays. Its uses, therefore, are those described in the preceding pages.

#### INJURIOUS EFFECTS OF VISIBLE AND INFRA-RED RADIATION

As with any form of heat, overexposure to infra-red radiation may produce burns. This danger is increased when treating patients who are unable to indicate their reactions as in unconsciousness or infancy, and also when the region is devoid of normal thermal sensibility, for example, in syringomyelia, scars, and anesthetic areas. Damage may also be produced as a result of overdosage. This is especially true where the circulatory response is poor, as in peripheral vascular disease. Cataract has been described as occurring in workers who expose themselves to intense radiant heat such as that found in glass factories. This type of damage is due to interference with nutrition of the lens by the action of infra-red radiation upon the iris and the ciliary body. The eyes of some persons are particularly sensitive to light. Their conjunctiva may become inflamed and lacrimation be stimulated upon exposure. Light may also produce chemical changes in the retina. The rapid disappearance of visual purple on exposure to light is indicative of vitamin A deficiency. Many persons are unable to sleep satisfactorily in light surroundings. For these, eye shades are of assistance. A sensitive skin, particularly if it be the site of an acute inflammation, should limit the use of radiant heat. It is possible to produce heat stroke by artificial means as well as by exposure to solar radiation.

#### REFERENCES

- ANDERSON, W. T., JR. Physical aspects of infra-red radiant energy in therapy  
*Arch Phys Therapy* 18 11, 1937
- BACHEM, A., and REED, C. J. Skin and radiation *Arch Phys Therapy* 12 581,  
1931



there is inadequate drainage from a sinus, heat may aggravate the condition. Radiant heat is of value in the care of inflammation of the ear, both of the external auditory canal and of the middle ear with adequate drainage through the tympanic membrane. In the treatment of erysipelas the combination of phototherapy and ultraviolet radiation is more effective than the ultraviolet alone, particularly when the involved area is covered with hair.

I have observed excellent results in the care of peripheral facial palsy (Bell's) following phototherapy applied daily. I follow this treatment with static brush discharge during the first two weeks of the disease, and with electrical stimulation after the initial two weeks.

An inadequate reaction may be photothermally stimulated in the treatment of indolent ulcerations. Radiant energy applied to such areas for one-half to one hour daily may make the difference between healing and non-healing. Overdosage of heat may injure the comparatively delicate new cells of granulation tissue.

Phototherapy may be combined with ultraviolet radiation for stimulating purposes. In the treatment of burns, a radiant heat source may be permitted to shine on the involved part; or better, a thermostatically controlled heating hood in which the source of heat is luminous may be placed over the injured area. The latter permits the regeneration of tissues in a thermal environment which may be more suitable for their growth than are ordinary atmospheric conditions. It is in the treatment of peripheral vascular disease that the thermostatically controlled hood finds its chief therapeutic place.

Phototherapy is applied systematically for several purposes. When of sufficient energy it will bring about elevation of systemic temperature (Chapter VII). Used for relatively short periods of time, it is indicated in the treatment of functional neurological disturbances. For this, the cabinet bath is usually employed. Rheumatoid and arthritic states may be treated in a similar fashion. Mild application of radiant heat may also be used to cause a temporary lowering of blood pressure in hypertension. The copious sweating which this form of heating can produce helps to eliminate metabolites through the skin. This may be of particular value in the presence of acute or chronic inflammations of the kidney.

#### CHROMOTHERAPY

The therapeutic use of various portions of the visible spectrum has been advocated. Attention has been called to the fact that in patients suffering from smallpox, suppuration and scar formation are less likely to occur when the patient is placed in a room lighted only with red light. This treatment

## CHAPTER V

# LONG WAVE DIATHERMY

### LONG WAVE AND SHORT WAVE DIATHERMY

**E**LECTRIC CURRENTS OF HIGH FREQUENCY ARE EMPLOYED extensively in medicine for the converse heating of tissues. The term "long wave" is applied to currents whose frequencies are of the order of one million or less, the term "short wave" to currents with frequencies of about ten million or more. It has been claimed that the short wave currents can produce effects other than thermal, but these claims have not been substantiated. Therefore, both varieties of high frequency currents are grouped under the same heading of "diathermy." Long wave diathermy is the older method. It is referred to as the "conventional" method. During the past decade the trend has been toward the increasing use of the short wave current, so much so that many practitioners do not own a long wave diathermy machine. While the short wave machines possess many advantages, including the important one of greater ease of application, there are some valuable treatment techniques which require the long wave apparatus. Both devices should be included in the armamentarium of those who would practice physical medicine. The differences in the characteristics of these two currents, in the apparatus necessary for their production and in their clinical applications are discussed in this and in the succeeding chapter.

### APPARATUS THE MACHINE

The diathermy machine is a device for the production of a rapidly alternating electric current. Such a current produces heat when it is applied to the body. When a flow of electric current is interrupted at very short intervals, it causes neither an irritating sensation nor muscle contraction. To avoid effects other than thermal the frequency of the interruptions should be greater than 10,000 per second. Changes in current flow at such frequencies can be produced by an oscillating electrical circuit containing a spark gap, condensers, and a coil. The diathermy machine utilizes the electrical energy secured from a source of alternating current. If alternating current is not

- BIERMAN, W. The effect of photothermal radiation upon cutaneous and subcutaneous temperatures. *Arch. Phys. Therapy*, 14 : 717-721, 1933.
- CLAUSEN, E. M. L. Use of isolated radiations in experiments with rats; effect of infra-red radiation on growth of rachitic rat. *J. Nutrition*, 2 : 125-153, 1929.
- KROGH, A. The Anatomy and Physiology of Capillaries. New Haven, Yale Univ. Press, 1929.
- LAURENS, H. C. Physiological Effects of Radiant Energy. New York, Chemical Catalog Co., 1935.
- LEWIS, (SIR) THOMAS. Blood Vessels of the Human Skin and Their Responses. London, Shaw & Sons, 1927.
- LUCKIESH, M. A., and PACINI, A. J. Light and Health: Discussion of Light and Other Radiations in Relation to Life and to Health. Baltimore, William & Wilkins, 1926.
- LUDWIG, F., and VON RIES, J. Über den Einfluss der Rot- und Blaustrahlen auf das Wachstum. *Strahlentherapie*, 39 : 485, 1931.
- VON RIES, J. Die Beeinflussung der Narbenbildung durch Lichtfilter. *Wien. klin. Wchnschr.*, 35 : 702, 1922.
- VOLLMER, H. Studies on biologic effect of colored light. *Arch. Phys. Therapy*, 19 : 197, 1938.

available, direct current must be converted to alternating by a rotary converter or some other method

The mechanism involved during each half cycle of the alternating current

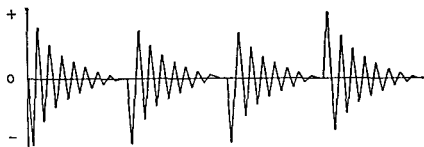

DAMPED HIGH FREQUENCY CURRENT

FIG 53 Damped high frequency current.

is as follows. The current is first led to a transformer where its voltage is increased (Fig 52). From the transformer it goes to the condensers, which become charged to a level sufficiently high to permit the current to jump across the air space between the points of the spark gap. This completes the circuit through a wire coil—the “solenoid.” The patient is connected to the solenoid either directly or inductively. A prolongation of the solenoid which develops a current of higher voltage and correspondingly lower amperage leads to a metal knob, called the “Oudin terminal.” The discharge of the condensers across the spark gap creates a train of current oscillations of high frequency, whose amplitude diminishes rapidly due to losses in the circuit until the energy stored in the condenser is exhausted. With the next half cycle of the alternating current, the same process is repeated (Fig 53). Current ceases to flow until the condensers again become charged to a level where sufficient energy accumulates to permit the current to jump across the gap. The charge of the condensers and spark discharge takes place in each half cycle, or 120 times a second if a 60-cycle alternating current is used. The frequency of the damped oscillations varies with the design of the machine from 500,000 to 1,000,000 or more per second.

Figure 54 shows a schematic panel board of a long wave diathermy machine. The patient is connected to the two *binding posts* during the usual diathermy treatment. The current is turned on by throwing the *main switch* to the “on” position. The *choke coil* controls the quantity of current which is permitted to flow into the machine in the same manner that water is controlled by a faucet. By turning this adjuster, the quantity of current flowing into the machine can be controlled. The choke coil is opened in gradually increasing steps, numbered one, two, three, four, and so on. At the beginning

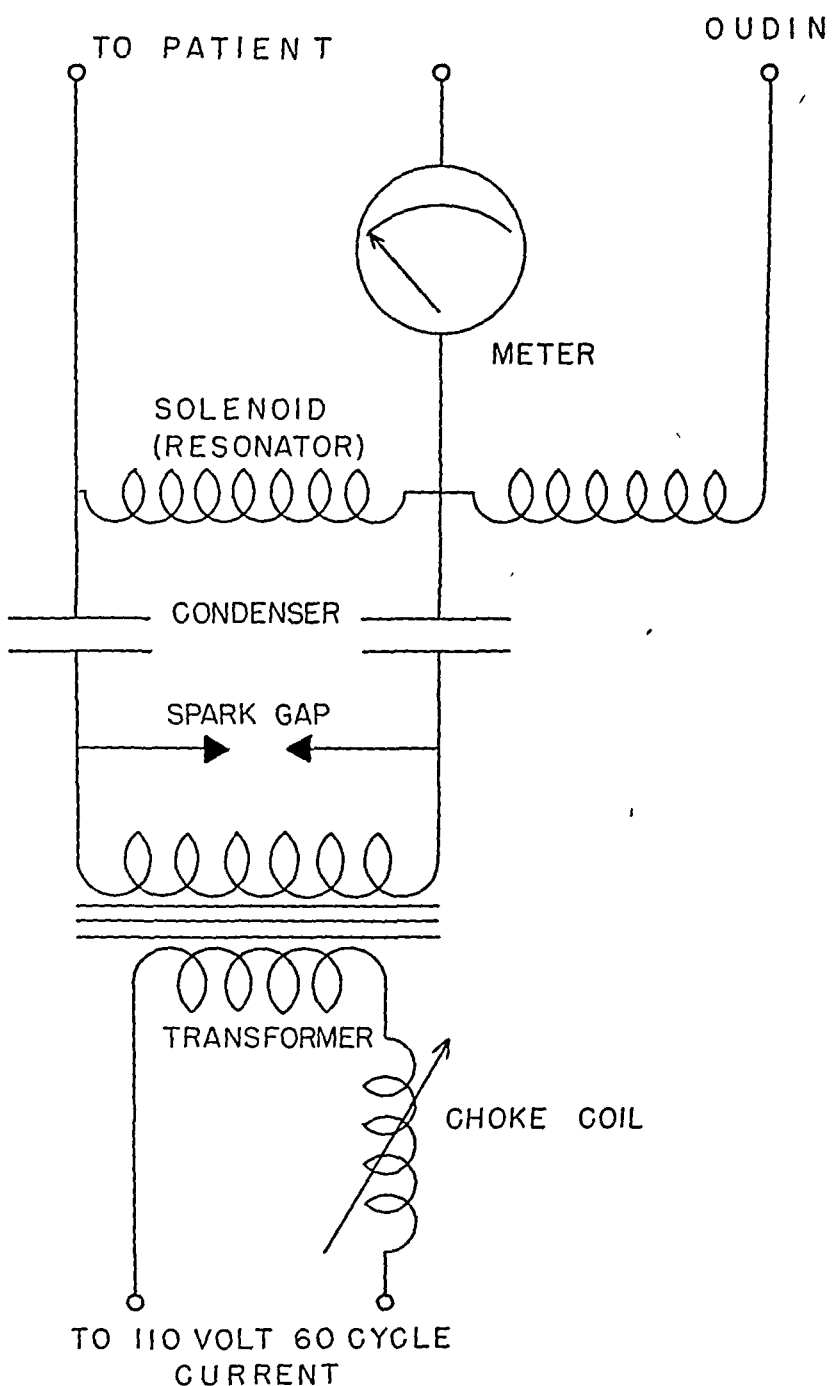

Fig. 52. Schematic long wave diathermy circuit.

## SPARK GAPS

Multiple spark gaps are provided in modern diathermy machines. Their opposite flat surfaces are made of tungsten which will withstand the pitting and oxidizing effect that the current has on other metals. These surfaces should be in close apposition to each other when the gap is closed. If they become somewhat irregular after long use, they should be cleaned with a fine grade of sandpaper. This may be done by folding the sandpaper so that its rough surface is in contact with the metal surfaces of the gap which should be closed to a distance which will permit the even application of the sandpaper. If the irregularities of the gap surface are too great to be evened off by means of sandpaper, they should be adjusted by the company which sold the apparatus. Spark gaps are equipped with thin metal vanes to radiate heat. They may be regulated to open or to close the spaces between the two, three, or all the plates simultaneously. Before opening the main switch, one should make certain that all the gaps are closed tight. After the choke coil has been properly adjusted, the spark gap should be opened slowly. The current flowing across them should produce an even hissing sound, if the gaps are opened too widely, the sound becomes sputtering in character. This can be corrected by reducing the size of the air space. The quantity of current in the patient's circuit can be controlled by means of the spark gap. With a little experience the optimum spark gap distance on a given machine is soon determined. After the current has been permitted to flow for a minute or so, the spark gap may be closed again and the previously described adjustments made on the choke coil. This procedure may be repeated for from three to five minutes before the current is permitted to flow for the remainder of the treatment.

## THE METER

The quantity of current in the patient's circuit is indicated by the *milliammeter* with sufficient exactness to be of clinical value. This meter may be provided with either one or two scales. In the latter instance the smaller scale usually extends from 0 to 1000 milliamperes, the larger, from 0 to 4000 milliamperes. A switch permits the utilization of either scale. At the beginning of a treatment the needle on the scale should be turned to zero by means of the adjusting screw. Some machines are equipped with a fuse to prevent the meter from being burned out if too much current is permitted to flow through it. These small fuses are readily replaceable. However, since most of the machines are not so equipped, the operator should make certain

of a treatment the first step should be used. After the *spark gaps* have been slowly opened, and the current permitted to flow for a minute or so in the patient's circuit, the gaps are closed and the indicator on the choke coil

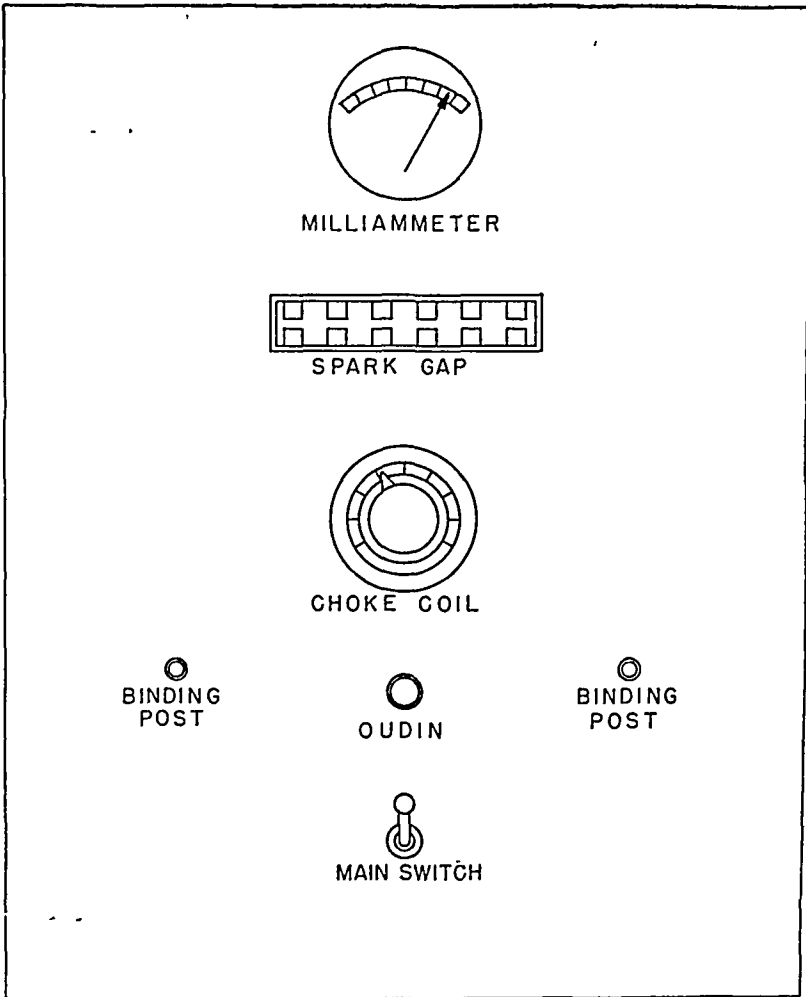

FIG. 54 Schematic panel board of long wave diathermy machine.

moved to step two. This procedure may be repeated with each of the steps; or the spark gap may be left open as the indicator is moved through the successive steps. Initially, only a small quantity of current should be permitted to flow into the patient's circuit, in order to minimize possible injury to the patient through faulty technique. For example, if the metal clip attached to the plate which is placed on the patient slips off, the result with a weak current is merely a slightly unpleasant sensation; with a strong current there will be a severe burn.

Special jellies have been manufactured for the purpose of establishing good electrical contact between the plate and the skin. Those with an aqueous base (commonly used for lubrication) are serviceable, but in general, these jellies

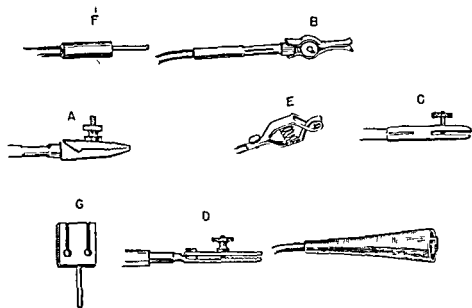

FIG 55 Electrode clips *A B C D* are clips depending on screws to hold the jaws tight on the electrode *E* Fahnestock clip *F* Rod tip for insertion into binding post hole *G* Divider to permit two contacts at one binding post

are unnecessary and expensive. They are of value only for special purposes, such as in making good electrical contact on the application of face electrode masks and for the lubrication of orificial electrodes.

The metal plates which serve as the contact electrodes are usually made of 22 gauge block tin. Thinner metal wrinkles too readily, thicker metal is less pliable and therefore more difficult to bring into close apposition with the skin surface. Very thin metal, like tinfoil, can be used to advantage to line plaster casts made to fit irregular contours. This method of making electrodes is a good one, for example, in the treatment of paranasal sinusitis. A plaster cast of the face which covers all the sinus areas may be made of a good grade of slow setting dental plaster (Fig 56). Before the plaster is poured the face should be well greased with vaseline, especially the areas where there is hair, as around the eyebrows and eyelashes. The upper part of the face is then encircled by a thin strip of electrode metal to form a mold for the plaster. The region of the mouth is not included nor is that of the nostrils. I have found it most convenient to cut a piece of block tin so that it bridges the lower portion of the nose and extends on to the sides of the cheeks, there to meet a metal band coming down from the forehead to the outer ends



that the flow of current is not beyond the capacity of the meter. This can be done by quickly throwing the main switch to the off position if the needle is moving completely across the face of the meter. For some uses (as when applying the current for surgical purposes) it may be advisable to take the meter out of the circuit. Some machines are equipped with a switching device for this purpose.

When the diathermy current is used for surgical procedures, a foot switch should be connected in the réceptacle provided for it. Some machines are also equipped with a separate circuit for the application of the so-called "cutting current." A switch on the panel controls this special circuit.

#### ELECTRODES

The electric current is conducted to the patient by means of cords connected to the metallic plates which are placed on the part of the body to be treated. One end of the cords or "rheophores" is inserted into the binding posts on the machine; the other is clipped to the metal plates. Mechanically, this connection to the plate is a weak link in the circuit. There are a number of ingeniously constructed clips which serve this purpose well (Fig. 55). I have found the Fahnestock spring clip efficient. A disadvantage of many clips is that too much time is required to fasten them securely and to loosen them at the termination of the treatment. Occasionally clips slip off.

The metal plates which carry the current to the body are placed in direct contact with the skin surface. To insure good contact, some physicians interpolate a layer of fabric soaked in saline solution between the plate electrode and the skin. Others use soapsuds applied with a shaving brush to the surface of the electrode to be placed on the skin. Some use plain water for the same purpose, while still others apply the plates dry. I have found the soapsuds technique to be satisfactory. It takes but a fraction of a minute to whip up a lather in a shaving mug and apply it to the electrode. Although the saline-soaked pad technique is considered satisfactory by many, it is more awkward than the soapsuds method, and the solution tends to drain toward the lower portion of the material so that there may be a region of dryness if the treatment is prolonged, thus increasing the possibility of burns. The advocates of the dry technique maintain that if the current is applied in increasing strength, perspiration accumulates underneath the metal, producing good contact with a moist skin. These three techniques have each been used in the treatment of many thousands of patients. The fact that each works well indicates that different men develop different techniques which appear to be equally effective for the same purpose.

of each cheek. These two portions of metal may be held together with an ordinary paper clip. Any sharp edges on the surface of the cast opposed to the skin should be smoothed out. Several hours after the plaster has hard-

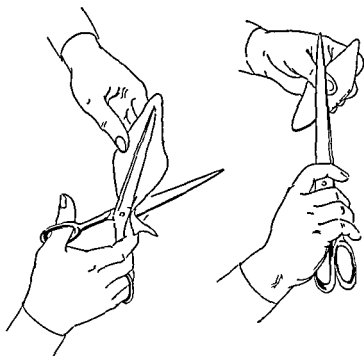

FIG 58 Cutting of long wave diathermy electrode and rounding of edges

ened, its inner surface is lined with a thin layer of plasticine. This is covered with tinfoil. The tinfoil is bent around the sides of the cast and on to its upper surface where, by means of a strip of metal, it makes contact with the clip on the electrode cord connected to the diathermy machine (Fig 57). I have never seen injury to the eyes during diathermy treatment. However, if it be desired to avoid applying the diathermy current to the eyes, they may be covered by some substance like plasticine during the pouring of the cast. The plasticine can be readily removed from the surrounding plaster after the latter has hardened.

The corners of metal plates should be rounded inasmuch as the current tends to concentrate at these points. Similarly, the edges should be rounded. This may be accomplished by running some relatively dull instrument along the edge to shave off some of the material on either side and thus produce a rounded end. A pair of shears or bandage scissors is a good instrument with which to cut the metal (Fig 58). In shaping the electrode it is convenient to leave a tongue of metal to which the clip of the rheophore may be attached. This metallic strip can then be bent backward on the plate so

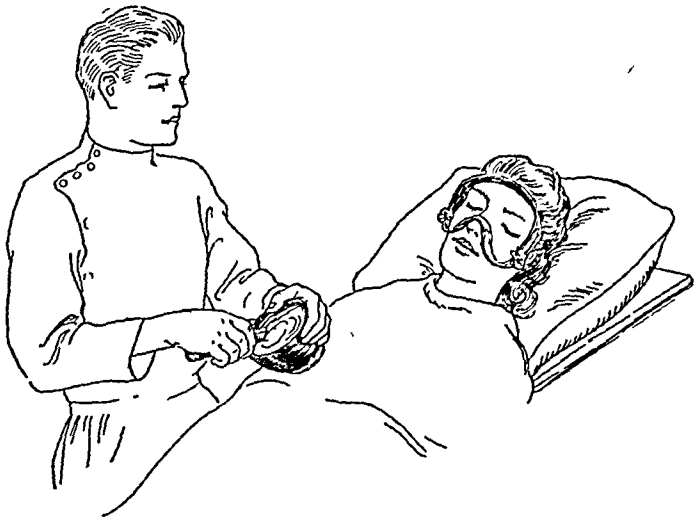

FIG. 56. Making plaster cast electrode for face. The two strips of flexible metal are held in place with paper clips.



FIG. 57. Cast in place on face.

by the subjective sensation of the patient. The upper limit of current density is not permitted to go above 100 milliamperes per square inch of the smaller electrode surface.

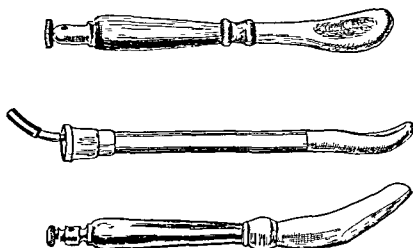

FIG 60 Rectal electrodes

Plate electrodes can be held in position by the weight of the body when the patient lies on them, or by sandbags, or by encircling bandages. The latter must be made of a yielding substance such as cotton cloth with rubber strands in it, or sheet rubber. I have found sheet rubber the more satisfactory. The bandages should be applied relatively loosely with the ends tucked under the outer layer. Even when so applied, they may cause a sensation of pain and tension if the treated part becomes enlarged following the augmented flow of blood and lymph and the increase in intercellular fluids. Whatever the method used, the electrode should be held firmly against the skin, otherwise there is danger of arcing and consequent production of a burn.

The region around the rectum and vagina can be effectively heated with orificial electrodes. These are made of metal and connected to a metal shaft running through an insulated holder to join the electrode cord going to the machine. Rectal electrodes have been made in many sizes and shapes, some are cylindrical with rounded ends, and others are curved (Fig 60). Some are of insulating material inlaid with a small metallic surface on the side applied to the prostatic region. One electrode has been constructed with a hinge in the middle, so that the flat surface will open after the instrument has been inserted into the rectum. With this instrument there is danger of pinching the anal mucosa. For most purposes, I consider the cylindrically shaped electrodes the best. They may be introduced with the least discom-

that irregular surfaces are not presented to the skin. Before it is applied, the metal plate should be smoothed out. This is readily accomplished by rolling a squeegee over it after it is placed on some hard surface like a slab of

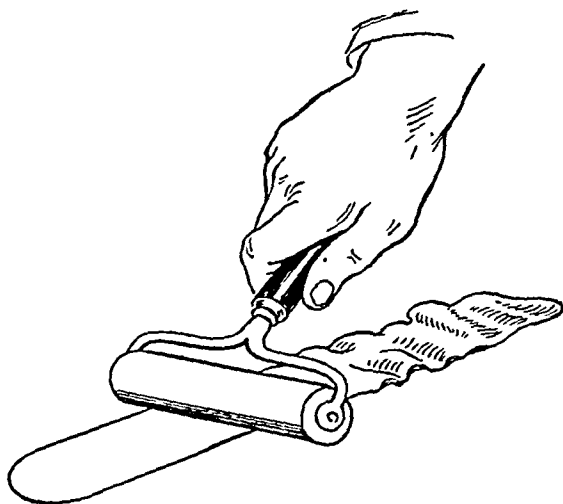

FIG. 59. Squeegee smoothing out irregularities in surface of long wave diathermy electrode.

marble, metal, or glass. Squeegees can be purchased in photographic supply stores. Better still is a heavy metal roller (Fig. 59).

The shape of the plate must be adapted to the region to which it is applied. It may be oblong, square, round, or cut in a long strip to form a cuff around an extremity or a belt around the abdomen. It may be irregular in shape, like the butterfly electrode for the region of the forehead, nose, and the cheeks. For production of systemic elevation of temperature, Neymann and Osborne used large plates with serrated edges, applied to the torso anteriorly and posteriorly.

The size of the plate, too, will vary with the region to be treated. When using the technique in which the electrode surfaces are parallel to each other on either side of the region to be heated, care should be taken to avoid bending the opposed edges toward each other. This is a common fault which is responsible for overheating in the relatively superficial areas lying between the edges of the plates closest to each other. Cuff and belt electrodes should not be too narrow. A good width is about three inches. The length of the belt should be sufficient to encircle a very large abdomen. For treating a smaller circumference, that portion of the belt which is unnecessary for skin contact can be bent back on itself. The two plates used need not necessarily be of the same size; a smaller plate may be applied on the side on which it is desired to concentrate the current. The strength of the current is gauged

fort to the patient and they can be made large enough to present a maximum metallic surface. It is convenient to have the electrode channeled to allow insertion of a thermometer down to its end. By this means it is possible to

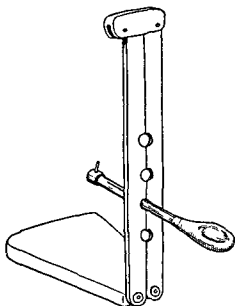

FIG 64 Holder for vaginal electrode

determine the temperature of the metallic mass of the electrode, which, in turn, is determined by the temperature to which the surrounding tissue has been elevated. While the electrode is in position, spasmodic contractions of the sphincter may cause it to be extruded or to be drawn further into the rectum. To prevent its internal displacement, the electrode should be constructed with a constriction at its outer end, and beyond this a flange or knob. A stand or sandbag placed between the thighs helps further to insure that the instrument will remain in place.

The female pelvis can be heated most effectively by means of a vaginal electrode (Fig 61). The larger the surface area of the electrode, the greater the amount of current which can be applied. We have constructed an electrode patterned after plaster casts of the vagina which is available in four sizes (Fig 62). A thermometer inserted into it serves to indicate the temperature of the tissues in contact with the electrode (Fig 63). The instrument can be held in place by a stand placed between the thighs or by sandbags (Fig 64).

Special electrodes have been advised for the treatment of the genitourinary tract. Cumberbatch employed a small rodlike electrode for the urethra and the penis. This organ can also be heated by placing it on the

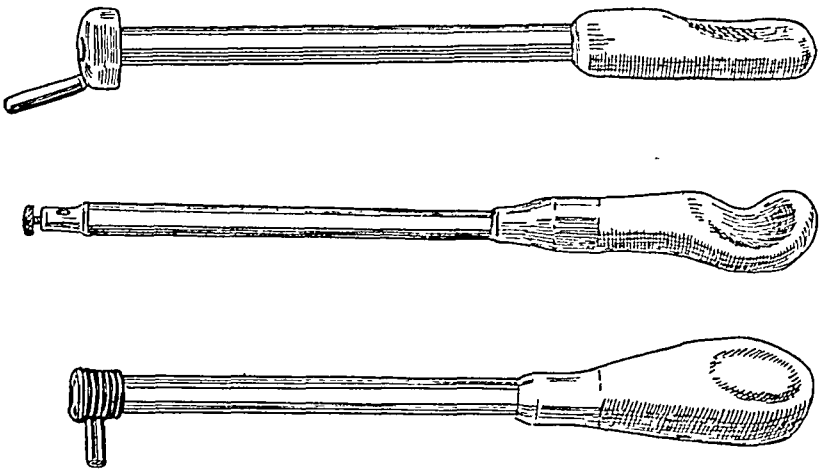

FIG. 61. Vaginal electrodes.

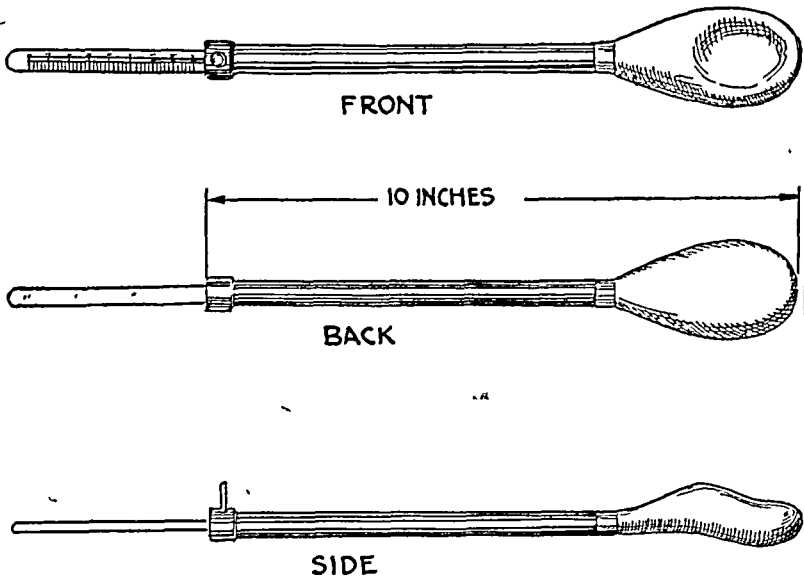

FIG. 62. Vaginal electrode fashioned from plaster casts of the vagina.

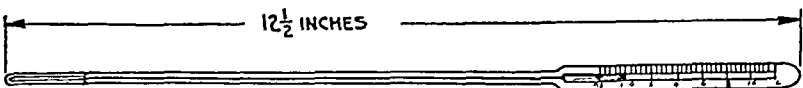

FIG. 63. Special thermometer for insertion into orificial electrodes.

When parallel paths are presented, the current will flow through the region of least resistance. This region will therefore become the hottest. When, however, the current is forced to go through tissues of high as well

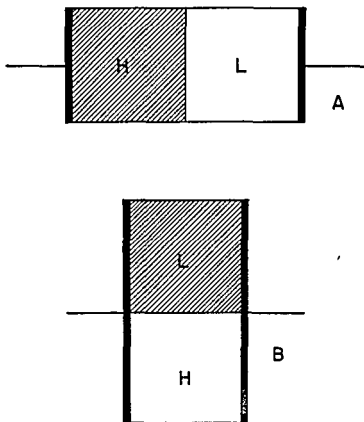

FIG 65 Influence of high and low resistance on diathermy current flow A Resistances in series *H* tissue of higher resistance *L* tissue of lower resistance Shading indicates that tissue of higher resistance becomes more heated B Resistances in parallel *L* tissue of low resistance becomes the hotter than tissue of high resistance (*H*)

as low electrical resistance in order to complete its circuit, the tissues of highest resistance will be the most heated (Fig 65). This is well illustrated when high concentrations of current are applied through an electrode placed on the abdomen. In such instances, coagulation of subcutaneous fat may occur without visible damage to the skin, the high resistance of fat causes it to become more heated than skin.

In human beings, the inequalities of tissue heating due to variations in electrical resistance are minimized by the flow of blood through the heated regions. Further equalization of temperature may result from the conductive transfer of heat from the tissues rendered hottest by the passage of the high frequency current. The position, relative sizes and shapes of the electrodes influence the temperature of the tissues lying between them. This is well



lower abdomen and then covering it with a metal strip. The rodlike electrode designed for the male urethra presents two disadvantages: It cannot be safely employed in acute inflammations of the canal; if it is inserted and held so that it presents a right angle to the electrode placed posteriorly, there is danger of concentration of current at the tip of the instrument. Corbus designed a clamp for heating the testes and epididymis. This has the disadvantage of exerting pressure on organs already made sensitive by the presence of inflammation. A piece of metal may be shaped to cover these areas. This makes a more satisfactory electrode. Light sandbags and a liberal application of soapsuds help to make good electrode contact.

Electrodes made of glass, both vacuum and non-vacuum, are now used much less than in the past. A glass electrode may be connected to one terminal of the machine while a metal plate, placed on some part of the body, is attached to the other; or the electrodes may be attached to the Oudin terminal. The irritating arcing which occurs between the glass and the skin surface produces an erythema. The area to be treated is covered with powder to permit the electrode to be moved smoothly over it. Vacuum and non-vacuum electrodes have also been made in shapes suitable for insertion into the nose. Toy machines producing a purplish discharge within vacuum electrodes have been sold to the laity as "violet ray" apparatus. They produce no ultraviolet radiation.

PHYSIOLOGICAL CHANGES PRODUCED BY LONG WAVE DIATHERMY

Diathermy produces heat within the tissues in accordance with Joule's law. The heating energy is directly proportional to the square of the strength of the current; to the resistance of the materials; and to the time during which the current is permitted to flow. It is obvious that the greater the intensity of the current and the longer its duration, the greater the total quantity of heat developed.

The resistance of excised human tissue to long wave diathermy current is measured in ohms as follows:

	<i>Ohms</i>
Muscle . . . . .	110
Kidney .. . . .	126
Spleen . . . . .	256
Skin . . . . .	289
Liver .. . . .	293
Bone .. . . .	1800
Fat . . . . .	2180

When parallel paths are presented, the current will flow through the region of least resistance. This region will therefore become the hottest. When, however, the current is forced to go through tissues of high as well

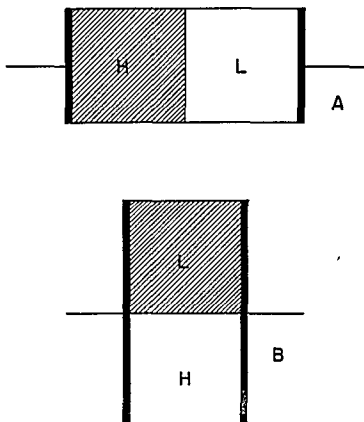

FIG. 65 Influence of high and low resistance on diathermy current flow. A Resistances in series. *H* tissue of higher resistance. *L* tissue of lower resistance. Shading indicates that tissue of higher resistance becomes more heated. B Resistances in parallel. *L* tissue of low resistance becomes the hotter than tissue of high resistance (*H*).

as low electrical resistance in order to complete its circuit, the tissues of highest resistance will be the most heated (Fig. 65). This is well illustrated when high concentrations of current are applied through an electrode placed on the abdomen. In such instances, coagulation of subcutaneous fat may occur without visible damage to the skin, the high resistance of fat causes it to become more heated than skin.

In human beings, the inequalities of tissue heating due to variations in electrical resistance are minimized by the flow of blood through the heated regions. Further equalization of temperature may result from the conductive transfer of heat from the tissues rendered hottest by the passage of the high frequency current. The position, relative sizes and shapes of the electrodes influence the temperature of the tissues lying between them. This is well

illustrated in the diagrams shown in Figure 66, which were based on the determination of the lines of current flow in an excised, relatively homogeneous medium, ground meat. It will be noted that the greatest concentra-

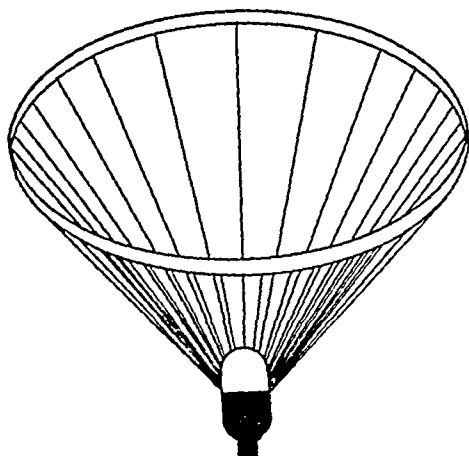

FIG. 66.

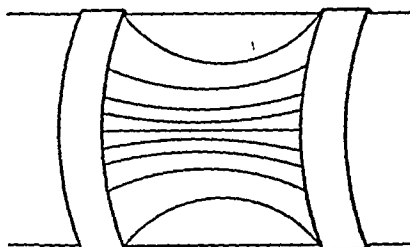

FIG. 67

FIG 66 Belt and vaginal electrode technique (schematic). The greatest concentration of current is in tissue that is in contact with the metal portion of vaginal electrode.

FIG. 67. Cuff electrode technique (schematic). Lines of current-flow pass deeply through tissue

tion of current occurs nearest the surface of the electrodes (Fig. 66).

In the living animal the influence of the varying factors responsible for the thermal changes produced by the high frequency current is most definitely determined by direct temperature observations. Binger and Christie found that the temperature of the lungs in live dogs could be raised 0.6° F. above the rectal temperature by applying diathermy to the chest. Interruption of the circulation of a branch of the pulmonary artery caused an elevation in the corresponding lung tissues of about 2.6° F. above the rectal temperature.

Application of diathermy to the eye of narcotized dogs caused the following temperature changes (Moncrieff *et al.*):

	<i>Average Maximum Elevation</i>
Orbit . . . . .	8° F.
Vitreous . . . . .	18° F.
Anterior chamber . . . . .	13° F.
Conjunctiva . . . . .	14° F.

These studies indicate the ability of diathermy to cause a definite elevation of temperature in the structures of the eye. As a result of studies on the application of diathermy to the carpal joints of the horse, Edstrom found that it was possible to raise the temperature of the joint from 7° to 9° F. Cloetta

and Waser observed an elevation of  $1.8^{\circ}$  F in the temperature of the brain tissue after the passage of diathermy through the head. With cuff electrodes applied to the leg in human beings, Tarbell and I found a distinct elevation in the temperature of the muscles of the calf (Fig 67). During vaginal diathermy, the temperature of the adjacent structures was raised. The temperature of the male posterior urethra was elevated on applying diathermy with a rectal electrode.

Other physiological changes produced by diathermy current are ascribable to the heat which it generates within the tissues. These changes are discussed in the section on the physiological effects of heat (page 1).

#### TECHNIQUE OF LONG WAVE DIATHERMY

The technique selected in the administration of the diathermy current should be adapted to the part to be treated and the structures to be influenced. Probably the most widely used technique is that in which the plates are placed parallel to each other on opposite sides of the region to be heated. For application to the head, for example, one metal strip is placed on the forehead and the other on the region of the occiput and upper neck, as the patient lies on a table. The weight of the body will hold the posterior electrode in position. The anterior electrode may be kept in place by an elastic bandage or by a light sandbag.

Diathermy may be applied to the eye either by direct contact with metal or with saline soaked cotton interposed between the metal and the eyelid. For direct contact the electrode is made of 22 gauge Crook's metal (Fig 68), cut in an oval shape and modeled to conform to the contour of the eye when the lid is closed. Its area is a little over one half inch. To a small extension on one end of the electrode, a light, insulated wire is attached, the other end being attached to one terminal of the diathermy machine. The electrode is moistened with water soluble jelly placed over the upper lid. A square of gauze is placed over this and the electrode is held snugly in place by means of a bandage wound around the head. The strength of the current should be 250 to 350 milliamperes, the duration, twenty to thirty minutes, usually thirty. When both eyes are to be treated, two electrodes of identical size are connected with a split cord. The dispersive electrode is placed on the back of the neck. This area must be thoroughly moistened (soapsuds are good for this purpose) to insure elimination of air spaces between the metal and the skin. Air spaces may also occur if a dry plate is placed over the region of hair. Therefore the hair should be moistened with water, saline solution, or soapsuds so that it lies flat. Another device used in treating the eye is a

bifurcated non-vacuum electrode so applied that its shallow depressions fit over the eyes. The patient holds the electrode in position by means of a handle.

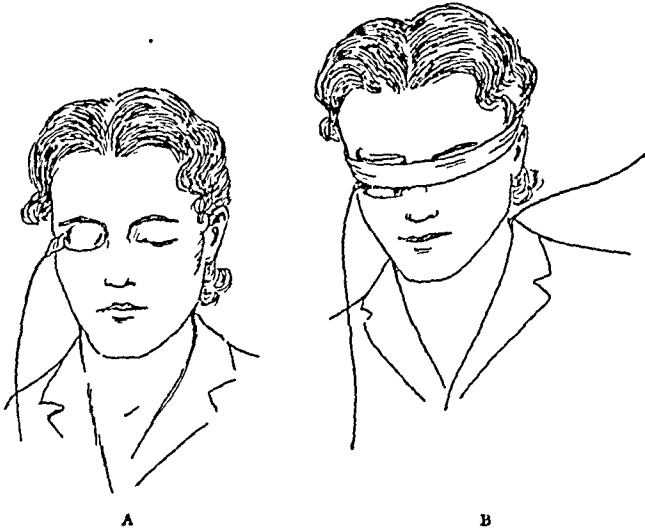

FIG 68. Diathermy to eye. Direct metal contact. A. Electrode in place on eyelid. B. Gauze and bandage serve to hold electrode in place.

The best diathermy electrode for the treatment of the paranasal sinuses is the plaster cast of the face already described (page 115). It is also possible to apply metal plates over the region of the sinus. A special headband with a projecting rod facilitates the holding of these electrodes. They may be moistened with a water-soluble jelly. The posterior electrode, which is relatively large, is placed on the neck and the upper back. Similar types of electrodes may be used for other portions of the face. For example, they may be applied to the sides of the face if the temporomandibular joints are to be heated.

The region of the ear presents difficulties. A technique which has been described consists of the insertion of the patient's index finger into the auditory canal after metal cuffs have been placed around the forearm and connected to the machine (Fig. 69). Small electrodes have been inserted within the external auditory canal. These techniques appear to be of value only for the treatment of localized conditions in and about the external auditory canal; they do not permit of adequate current concentration in the region of the middle ear. For this purpose it is better to cut the metal plates so that they will cover the area around the ear, or to place a smaller electrode on the area back of the treated ear and a larger one on the opposite cheek (Fig. 70).



FIG 69 Binaural technique with cuff electrode on forearm and fingers in ears

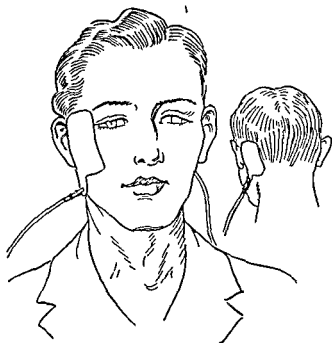

FIG 70 Diathermy to region of the ear One electrode is held behind the ear the other on the opposite cheek

To treat the muscles of the back of the neck, strip electrodes may be placed on either side; or the involved area may be covered by one electrode and a larger one placed on the chest. When the electrodes are disposed laterally, they may be held in position by a bandage around the neck; or if the patient lies on a table, his weight will keep the posterior electrode in position, and the anterior one may be weighted with a sandbag. With the coplanar technique both electrodes are placed on the same surface; one over the region of the occiput and neck, and the other on the upper back. The elevation of temperature so produced in the structures lying beneath the skin is of value in the treatment of cervical arthritis. To reach the structures within the neck, electrodes may be placed on its lateral aspects, or anteroposteriorly. To cover the region of the thyroid or of the larynx, small electrodes may be placed on either side of these organs; or one electrode cut somewhat like the outline of a butterfly may be placed on the anterior and both anterolateral aspects while the other, larger electrode is placed on the neck and upper back.

Anterior-posterior disposition of the electrodes is usually made in treating the organs lying within the chest. In pneumonia, for instance, the usual procedure is to apply one large electrode to cover the area of the involved lobe anteriorly, while another large electrode is placed posteriorly. The experiments of Christie and Binger indicate that this technique does not produce an appreciable increase in the temperature of the pulmonary tissue lying between the electrodes. The probability is that most of the heating occurs within the chest wall rather than within the lung tissues. When diathermy is used in the treatment of angina pectoris one electrode is placed over the projection of the heart area on the chest wall and another posteriorly.

Large plates applied anteroposteriorly are also employed in the treatment of the abdominal organs. For the most effective heating of the structures lying within the pelvis, orificial electrodes should be used: rectal electrodes in the male; and a rectal or vaginal electrode in the female. The larger the size of the inserted electrode, the greater is the amount of current which can be applied.

The configurations of the extremities present special problems in the application of electrodes. The region of the shoulder joint is particularly difficult. Here electrodes may be placed anteroposteriorly, and held in position posteriorly by the weight of the body as the patient lies on the table and anteriorly by a sandbag; or the electrodes may be tied in place by bandages wrapped around the body. In an attempt to avoid these awkward arrangements, sponge electrodes covered with metal mesh and held in place by a wooden

viselike frame have been used but they are not as satisfactory as electrodes with a smooth surface. The shoulder can also be treated by placing one electrode at the base of the neck and the other on the upper arm.

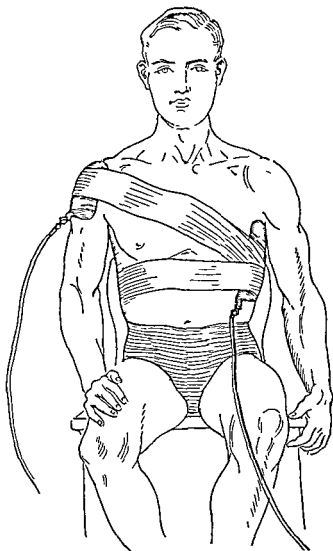

FIG 71 Diathermy to shoulder. The smaller electrode is placed on the shoulder, the larger on the opposite side of the chest.

Another technique consists in the use of a small metal plate on the shoulder and a large plate placed on the opposite side of the chest (Fig 71). The two shoulders may be treated simultaneously by placing electrodes on their external aspects. Still another shoulder technique is the application of one electrode in the axilla, the other on the shoulder. This technique is unsatisfactory as the arm must be held abducted. To secure maximum heating of the shoulder, the upper arm may be encircled with a cuff electrode, and



the other electrode (a strip) is placed between the shoulder and the base of the neck. When the objective is to secure comparatively ineffective heating, as in the treatment of subacute bursitis, the plates should be applied

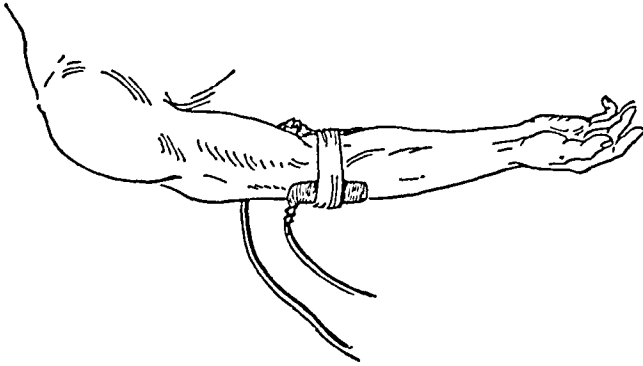

FIG. 72. Diathermy electrodes on elbow.

anteroposteriorly. To heat the entire upper extremity as, for example, in "brachial neuritis," one strip electrode about  $2\frac{1}{2}$  inches wide and 9 inches long is applied to the region of the lower neck and upper back on the side of the vertebrae away from the affected extremity; the other electrode is placed on the palm of the hand as the patient lies flat on the table. A cuff around the forearm may be substituted for the hand electrode. This will exclude the region of the wrist which otherwise becomes heated most. If the cuff is placed around the upper arm, the elbow, forearm, and hand will remain unheated. Cuffs placed above and below the elbow offer an efficient technique for heating that region. Less thorough heating of portions of the upper extremity will be produced by means of strip electrodes placed anteroposteriorly or laterally (Fig. 72).

The fingers, hand, and wrist can be treated by putting one electrode on the palm of the hand, while a cuff encircles the lower forearm. This is a good method for heating the wrist. This joint can also be treated by electrodes placed anterior and posterior to it. A commonly advised technique for heating the fingers consists in the use of a cuff electrode around the forearm, while the other electrode is immersed in a vessel containing salt water into which the fingers are placed. However, this procedure may prove ineffective, particularly if the temperature of the water is too low. It was found that with cool saline solution, the temperature of the skin surface of the fingers was lower after than before treatment. It is therefore important to make certain that the solution is warm, or to use some other technique.

Heating of the hip joint presents a difficult problem. Anterior-posterior

electrodes can be applied, or one metal strip may be placed on the lateral aspect of the joint while a larger one is put on the corresponding region on the other side of the body. The most efficient technique appears to be one

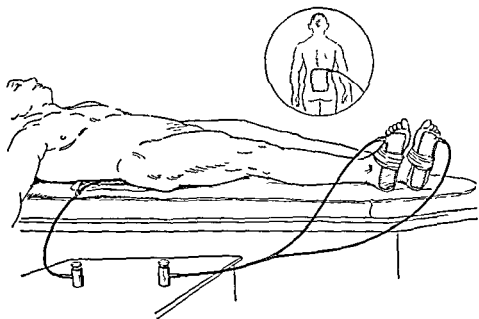

FIG 73 Diathermy to both lower extremities. Plates are placed on the feet. The large electrode on the back.

in which a cuff is fastened around the upper portion of the thigh and a half belt electrode placed over the lower abdomen on the side of the involved hip. The entire lower extremity can be treated by techniques analogous to those described for heating the upper extremity. One electrode can be placed on the lower back, while cuffs encircle the thigh or calf, or a plate is placed against the sole of the foot (Fig 73). In the treatment of sciatic pain the back plate should be placed high enough to cover the lumbosacral and sacroiliac joints. A three plate technique has been described for heating the lower extremity (Fig 74). Two of the plates (one over the calf and one on the lower back) are connected to one terminal of the machine by a bifurcated cord. The other terminal is connected to a metal plate placed on the region of the knee. This plate should be larger, as its surface must balance the current densities of the other two. When treating the knee joint, the electrodes may be applied laterally or anteroposteriorly, or cuffs may be used above and below the joints. For the ankle, good heating may be secured by laterally placed plates, or, more effectively, by a cuff above the ankle and a plate underneath the foot (Fig 75). For heating the heel, a semi cuff may be placed about the calf and a plate on the plantar aspect of the foot.

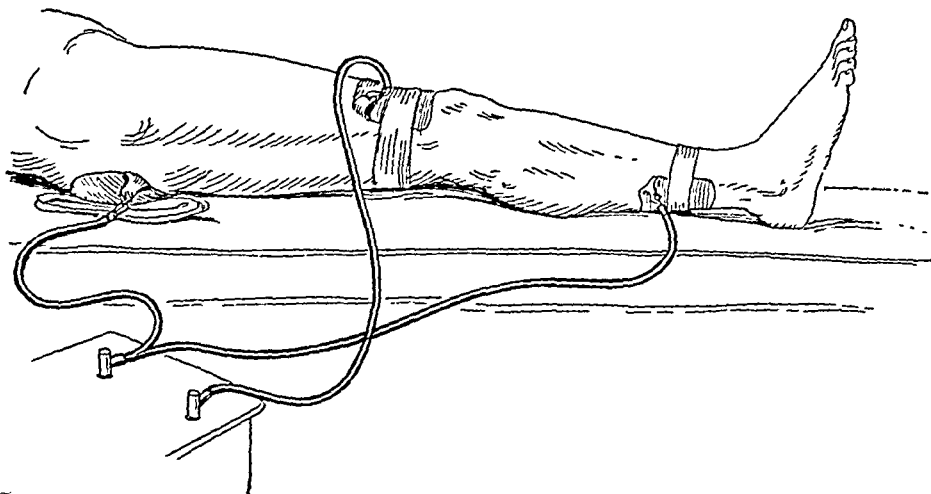

FIG. 74. Three-plate technique.

The coplanar technique is best adapted to the structures of the back of the body. To heat the entire spine, for example, as in vertebral arthritis, one plate is applied to the upper back and one to the lower back. This is

better than using long strip electrodes on either side of the spine, or one over the spine with a larger plate covering the anterior aspect of the body. Large sections of the back may also be treated in a similar fashion. For treating the lumbosacral or sacro-iliac joints, electrodes may be placed on the back either above and below the involved areas or lateral to them.

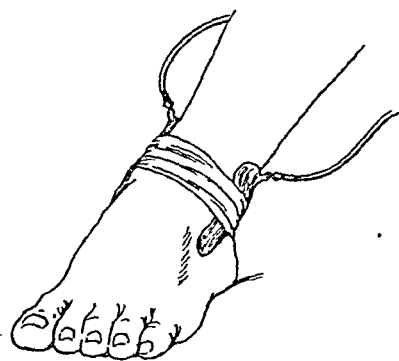

FIG. 75. Diathermy to ankle.

Autocondensation permits warming of the entire body (Fig. 76). For its applica-

tion the patient is placed upon an autocondensation pad. This is a metal sheet covered with some non-conducting material such as artificial leather, to which one terminal of the machine is connected. From the other terminal the current is led to a metal cylinder which is held by the patient as he lies on the pad. A pillow or some similar object is placed between the body and the arms. The greatest concentration of the current occurs in the region of the wrists. It is the ache produced there which limits the quantity of current employed. Usually from 500 to 800 milliamperes is adequate. Large fenestrated electrodes have been applied to the torso anteriorly and posteriorly to produce a substantial elevation of the body temperature, as in artificial fever therapy, but this technique has been generally discarded.

While numerous methods of electrode application have been described, it is obvious that a concept of the physical properties of the current and of the conductivity of the tissues to which it is applied, a knowledge of the

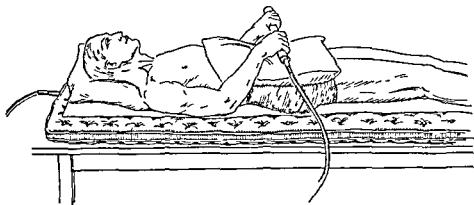

FIG 76 Autocondensation

pathological conditions involved, and of the proper dosage, plus the ingenuity of the operator must be the guiding factors in the successful use of diathermy

#### INDICATIONS AND CONTRAINDICATIONS FOR LONG WAVE DIATHERMY

The indications for diathermy comprise those conditions which may reasonably be expected to be improved by the active hyperemia produced by the current. Unlike conductive heating and photothermal radiation, the high frequency current can cause marked elevations of the temperature of tissues lying deeply below the surface of the body. As with the other forms of treatment, the best results are generally achieved in conditions in which the causative factor is no longer operating.

Traumas of soft tissues—sprains, contusions, ecchymoses, myositis, and arthritis—are especially responsive to the heating influence of this current energy. Fractures are treated with long wave diathermy, not in the hope of causing significant changes in the process of bony union, but to improve the condition of the injured soft tissues. Traumas and fractures respond more dramatically than other conditions to diathermy. To the physician who has not employed this agency previously, the rapid disappearance of large ecchymotic areas furnishes evidence of the value of the active hyperemia produced by the current. Ankle sprains, for example, frequently show marked improvement after one or two treatments.

Another large group of conditions which respond favorably to diathermy consists of chronic inflammations of muscle and connective tissue. Myositis,

fibrositis, and myofascitis should be treated by converse heating followed by mechanical measures, such as massage.

Bursitis must be treated cautiously. In the acute stages, cold applications afford the best results. As the acuteness subsides, some relatively ineffective heat application, such as phototherapy, is beneficial. Later the converse heat of diathermy should be applied. Synovitis and tenosynovitis are benefited by the application of this current. Diathermy has proved of value in the treatment of chronic arthritis; in the acute stage, it may cause increased pain and disability.

In "brachial neuritis" and "sciatica" diathermy may bring about cessation of the pain distribution in the involved nerves. Manifestations of motor nerve damage may also be improved if the damage is due to infiltrations produced by intravenous injections, trauma, or pressure such as that which may occur on the operating table. Diathermy is useful as an adjuvant in the treatment of atrophy of disuse following nerve injury or prolonged immobilization.

Diathermy has been used in hemiplegia after the immediate danger of further hemorrhage appears to have passed. It is difficult to evaluate the results of such an application because of the spontaneous improvement which may occur. In chronic paranasal sinusitis the results obtained are not universally good. However, improvement appears to be achieved in a sufficiently large percentage of patients to make this method of treatment worth trying. In trifacial neuralgia, diathermy has afforded relief in a sufficient number of instances to warrant its trial along with other physical therapeutic procedures before the inauguration of more radical measures such as nerve section or injection of alcohol.

In laryngitis, tracheitis, and bronchitis, this form of therapy frequently gives relief. In a group of cases of lobar pneumonia, long wave diathermy caused diminution in respiratory effort, improvement in cyanosis, and a gradual fall in temperature. It should, of course, be used only in conjunction with other measures which have proved to be of value.

The stimulating influence of the current on circulation is of advantage in treatment of peripheral vascular diseases such as arteriosclerosis or thrombo-angiitis obliterans. In these cases proper dosage is essential, since, with inadequate venous return, the engorgement produced by increased arterial supply may aggravate the condition. The response to diathermy seems to be greater in arteriosclerosis than in thrombo-angiitis obliterans. There is considerable doubt as to the value of diathermy in angina pectoris.

In patients who experience relief, the pain may have been anginoid in character or possibly the result of spinal arthritis. When applied generally to the body, as by autocondensation, diathermy has been used to lower elevated blood pressure. Its effectiveness in cases of hypertension is probably due to its influence in increasing the size of the peripheral blood bed, if so, its action would be essentially a temporary one.

Diathermy has been advocated in the care of various intra abdominal diseases. Its use has been followed by relief in some patients suffering from conditions such as cholecystitis, intestinal muscle spasm, and intra abdominal adhesions. It is possible that the reflex effect of the heat produced in the abdominal wall may account for such improvement.

In diseases of the pelvic organs, definite benefit can be ascribed to the heat produced by orificial electrodes. Inflammations of the tubes and the ovaries, the uterus, and the bladder are indications for this treatment. So also are gonococcal inflammations of the prostate, seminal vesicles, and urinary bladder. Dramatic changes may result from temperatures great enough to exert a direct thermolethal effect on the gonococcus. To achieve such high temperature values it may be necessary to raise the temperature of the entire body. The procedure for accomplishing this is discussed in the chapter on fever therapy (page 173). In chronic non gonorrheal inflammations the heat produced by diathermy current may prove very valuable. While diathermy may give rapid relief in acute gonorrheal inflammation of the epididymis, it may aggravate the symptoms in acutely inflamed tubes and ovaries.

Diathermy should not be applied in conditions in which active hyperemia may be harmful. It is not always possible to determine this in advance. In some instances the contraindications will be clear cut, as, for example, in the presence of confined pus without drainage. In such cases active hyperemia may break down the normal protective mechanism which the body develops in order to avoid dissemination of the infection. The harmful reaction becomes visible when the local infection becomes widespread, and lymphangitis and lymphadenitis become more prominent. When there is adequate drainage, however, the creation of active hyperemia may hasten resolution of the local inflammation. Inasmuch as the short wave current is used for treatment of localized infections, the question has arisen as to the possibility of applying long wave diathermy for the same purpose. Cumberbatch has shown that this is clinically feasible. The technical difficulty encountered in making direct contact with a very tender area makes applications of diathermy

more difficult than those of the short wave current. If the mechanical difficulties can be circumvented the basic considerations are the same for both types of current.

Some forms of acute inflammation without pus formation may also be contraindications to active heating measures. In acute arthritis, for example, local pain and tenderness may be aggravated by diathermy. A similar reaction may occur in acute inflammations within the pelvis.

When a tendency to bleed exists, it is obvious that the production of an additional flow of blood may increase the danger of hemorrhage. This may occur in recent hemoptysis, in the presence of duodenal or gastric bleeding, and during menstruation. In this latter state, it is customary to avoid application of diathermy to the pelvis. During pregnancy, likewise, the short wave current should not be applied to the lower abdomen. It is thought that because of the increased blood supply produced, it is inadvisable to apply the diathermy current to the region of a malignant growth. A state of relatively poor vascularization may also contraindicate diathermy. This obtains, for example, in peripheral vascular disease of the lower extremities in which energetic application of diathermy may give rise to cramps or pains, indicating an overheating of the muscles. In cases of deficient circulation, diathermy should be applied cautiously, if at all. It may be better to use less efficient methods of heat application, such as phototherapy. Phlebitis is also considered a contraindication.

While the muscles do not contain thermal nerve ends, normal skin does. This permits the patient to appreciate overheating and call attention to it before a burn occurs. However, in the presence of central nervous system or peripheral nerve injury, thermal sensation may be lost. In the absence of thermal sensitivity diathermy should be applied very cautiously, utilizing a current density well below that which could be safely applied to the normal skin. Where simpler heating measures are effective, it is best to avoid diathermy. This is true, for example, in the treatment of the skin, the fingers, or the toes. For these parts, radiant energy or hot water applications or heated paraffin may suffice. It may be difficult to apply diathermy to a very young infant. It is then best to place reliance upon simpler heating measures.

#### REFERENCES

- BINGER, C. A. L. General and local heat developed in living animal body by passage of high frequency currents. *Proc. Soc. Exper. Biol. & Med.*, 24 : 677-683, 1937.

- CLOETTA, M, and WASER, E Beitrage zur Kenntniss des Fieberanstieges *Arch f exper Pathol u Pharmakol*, 77 16, 1914
- CORBUS, B C, and O'CONNOR, V G Diathermy in the Treatment of Genito-Urinary Diseases with Especial Reference to Cancer Rev ed St Paul and Minneapolis, Bruce Pub Co, 1925
- CUMBERBATCH, E P Diathermy St Louis, Mosby, 1928
- EDSTROM, G Thermal effect of diathermy in treatment of joints *Acta Rheum*, 3 10, 1931
- MONCRIEFF, W F, COULTER, J S, and HOLMQUEST, H J Experimental studies in diathermy applied to eye and orbit *Am J Ophth*, 15 194, 1932
- NEYMANN, C A, and OSBORNE, S L The treatment of dementia paralytica with hyperpyrexia produced by diathermy *JAMA*, 96 7-13, 1931
- TARBELL, L, and BIERMAN, W Temperature determination during local application of diathermy *Arch Phys Therapy*, 15 645-648, 1934



## CHAPTER VI

# SHORT WAVE DIATHERMY

### APPARATUS AND PHYSICS

THE SHORT WAVE CURRENT EMPLOYED IN MEDICINE IS a product of advances in radio engineering. The term "short wave" indicates that the current is one of high frequency of alternations; it may have a frequency of ten million or more cycles per second, whereas the current commonly used in long wave diathermy has a frequency of less than one million cycles per second. Electric waves, like light, travel at the rate of about 186,000 miles or 300,000,000 meters per second. If, during a second, the current alternates fifty million times, the distance between one cycle and the next is six meters.

$$\frac{300,000,000 \text{ meters per second}}{50,000,000 \text{ cycles per second}} = 6 \text{ meters}$$

An ordinary diathermy current with a frequency of about one million times per second would yield a wavelength of about 300 meters.

$$\frac{300,000,000 \text{ meters per second}}{1,000,000 \text{ cycles per second}} = 300 \text{ meters}$$

This is a long wave when contrasted with the wave length of currents of higher frequencies. Therefore, the higher frequency wavelengths are referred to as "short." To indicate its relationship to conventional diathermy, the trend in American literature is to refer to these higher frequency currents as "short wave diathermy." This current differs from conventional diathermy not only in its frequency and therefore in its wavelength, but also in the form of its wave. The mechanism of its production yields an undamped wave as contrasted with the usual damped wave of diathermy (Fig. 77).

In comparison with conventional diathermy, this current of much higher frequency possesses a number of advantages. It is simpler to apply. There is

not the need for exactness of contact between body surface and electrode. Neither is there so great danger of concentration of current at the electrode edges. Uneven body surfaces offer less possibility of current concentration.

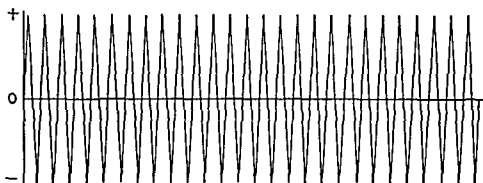

UNDAMPED HIGH FREQUENCY

FIG 77 Undamped oscillations

There occurs a more homogeneous heating of tissues of differing electrical characteristics.

The basic physical considerations involved in the construction of a short wave machine are described by Schwarzschild and by others. Figure 78 illustrates a simple circuit for the production of the short wave current. The filament is heated to incandescence by means of an auxiliary circuit not shown. The oscillatory circuit, consisting of an inductance and condenser of size suitable to oscillate at the frequency desired is included in the dotted lines. This circuit is often called the "tank circuit." The grid of the tube is connected to the filament through an inductance which is magnetically coupled to the tank inductance.

When the generator is connected, and the filament is lighted, current flows to charge the condenser and to produce the magnetic field about the tank inductance. This establishment of the field causes a voltage to be induced in the grid coil, so that the grid is momentarily negative. The flow of current from the generator is now interrupted by the tube (negative grid) and the condenser discharges into the inductance. The tank circuit is now in precisely the same condition as if there were no generator and no tube connected to it. An oscillation occurs. Due to the feedback, or grid excitation voltage, during the next oscillation the grid again becomes positive, allowing current to flow from the generator through the tube. This flow makes good the loss due to energy taken by the load.

The oscillations are thus maintained by means of a boost once each cycle. A very simple analogy is the swinging of the pendulum or balance wheel in

a clock. Once in each half cycle the wheel or pendulum is given an extra push by the spring through the escapement. So here, once in every cycle, the oscillatory or tank circuit is boosted by the generator through the tube.

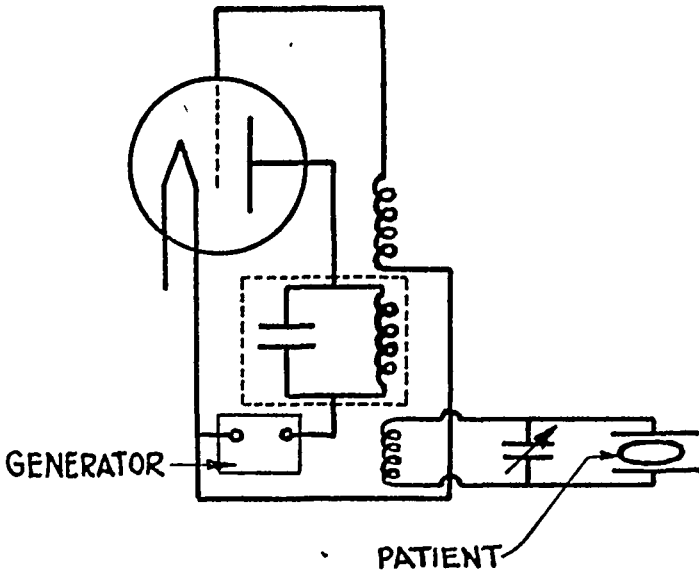

FIG. 78. Schematic diagram of essential elements of a simple tube oscillator circuit. (Bierman, W. Medical Applications of the Short Wave Current. Courtesy of Williams & Wilkins Company.)

When current flows through the tube there must exist a voltage across the tube in the direction of the flow. This is equivalent to the statement that there is a loss of energy in the tube, which is converted into heat.

The patient's circuit is inductively coupled to the tank circuit. There is therefore no direct connection between the patient's circuit and the current source. In the patient's circuit the part to be treated is placed in the field between two condenser plates. These are metal plates covered by some non-conductor, like rubber or glass.

In another arrangement a cable connected to the patient's circuit is wound around the part to be treated. This cable is referred to as an induction cable.

When using the condenser technique, the plates are usually held some distance from the skin surface. The medium intervening between the plates and the skin may be air, felt, toweling, or some other substance with poor electrical conductivity. The relative electrical conductivity of the substance is referred to as its "dielectric constant." This varies greatly with different materials. That of air was arbitrarily chosen as zero. Water, a

better conductor, has a dielectric constant of eighty. Inasmuch as the soft tissues are composed essentially of water, the dielectric constant of the body approaches the value of water. However, not all the body tissues have the same dielectric constant. That of fat, bones, and fibrous tissue is much lower than that of muscle, blood, and soft tissues like the liver and the brain. These marked differences in the electrical conductivity of various body tissues account for the distribution of the electric current in the body when applying long wave diathermy. With short wave diathermy, however, the marked differences in the concentration of the current within the electrical field are not so great.

The ability of the short wave current to heat more homogeneously, tissues which are electrically heterogeneous, makes it in some instances a method of greater efficiency than long wave diathermy. Some thermal inhomogeneities do exist. Fat, for example, becomes more heated than muscle. With the development of apparatus producing currents of shorter wavelengths, these temperature differences have become increasingly diminished. It has been shown *in vitro* that it is possible to heat selectively differing concentrations of electrolytes with currents of different lengths. *In vivo*, however, any such selective heating is counteracted by the equalizing influence of a rapid circulation and by the shielding effect of surrounding tissues. The danger of selective overheating of bone marrow does not exist, according to Osborne and Coulter, who found that in the living animal the temperature of adjacent muscle is higher than that of bone marrow.

The greater ability of the short wave current to heat tissue of poor electrical conductivity may be explained if we consider that this energy is made up of two components of which one is conductive. This type of current is also present in long wave diathermy. The ohmic resistance of the tissues to the passage of this conductive current accounts for the production of heat. The other component, unimportant in diathermy, is called the displacement current. This type of current has been explained as resulting from changes in the orbits of electrons within atoms or the extremely rapid reversal of dipolar entities in the very quickly changing electric field. These dipoles contain ions oppositely charged at their two ends. The energy expended in their effort to rotate in order to orient themselves in the reversing field produces heat. When applying short wave, the actual current at any point is the sum of the conductive and displacement currents.

In long wave diathermy the distribution of current in the body is largely determined by the position of the better conducting layers, vascular struc-

tures, and the like. In short wave applications, the current is more homogeneously distributed because its flow depends not on conductivity alone but also on the dielectric constant of the tissues. In general, it can be shown that the difference in heat developed between different types of tissue for the same current are less pronounced with short wave than with diathermy. In fact, the higher the frequency, the more uniform will be the distribution of heat in different kinds of tissues.

In long wave diathermy we know that for the same current, tissues of higher resistance (lower conductivity) will be heated more. This idea is not applicable when the frequency becomes as high as it is in the short wave. For each type of tissue of a specific resistance, there is a frequency which will cause it to become heated to a maximum. In general, the higher the frequency (the shorter the wavelength) the more equally does heating occur in tissues of varying electrical resistance.

Another very important difference between the high frequencies of short wave therapy and the lower frequencies used in long wave diathermy lies in the ability of the short wave currents to traverse a complete gap in the conducting circuit. Such a gap exists in the usual method of applying short wave therapy between the electrodes and the patient. The resistance of such an air gap is enormously high and for this reason long wave diathermy currents would be unable to pass over it. The dielectric constant of air, however, is sufficiently large to permit the passage of high frequency currents, the distribution of which is virtually independent of resistance.

The lines of current flow in the air space between the electrodes and the patient depend on geometric relations. For example, if a small electrode is placed near a large body, the lines of flow in the air space will diverge. On the other hand, if a large electrode is placed near a body which is small compared to the electrode dimension, the lines of current flow will tend to converge. It is for this reason that the size and spacing of electrodes is an important consideration in the therapeutic application of high frequency currents (Fig. 79).

There has been a tendency in the past to believe that the lines of current in diathermy flow directly from one electrode to the other. This is, of course, erroneous. The field establishes itself by a spread through a large part of the medium. In most instances the concentration of current is greatest at the electrode and diminishes in value as it penetrates the tissue.

There is a tendency for more heat to be developed in the region between two electrodes when they are placed close to each other, but if the electrodes

are further apart, the heat developed near them represents virtually all of the energy, while that developed in the rest of the body becomes diffused. If the body to be heated is small as compared with the size of the electrodes,

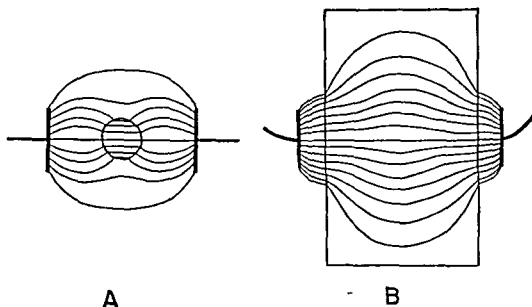

FIG 79 Current flow with air spaced electrodes (schematic) A Electrodes are large in relation to object B Electrodes are small in relation to object (Bierman W Medical Applications of the Short Wave Current. Courtesy of Williams & Wilkins Company)

and these are so arranged that the current must flow through the part to be heated, heating will be uniform throughout the entire space. Similar considerations apply in short wave.

In a large homogeneous body exposed to the field between two properly spaced plates, the lines of flow and the heating are essentially the same as those which would be obtained with diathermy with contact plates of somewhat larger size than those used in short wave. In a small body, the lines of induction tend to bend in and fill it so that the heat distribution is quite uniform, with possibly a somewhat greater concentration at the center. Such an effect can be produced with diathermy by using cuff electrodes. The field would be very similar and the heating would have essentially the same distribution.

With a homogeneous body, it appears to be possible to duplicate with long wave diathermy the distribution which would be obtained with short wave. The principal advantages of short wave would then lie in the ease of application, since a direct contact is not required, and also in the more homogeneous heating of a heterogeneous body.

Figure 80 illustrates the meters and controls on a short wave machine. In the administration of treatment, after the machine has been connected to the alternating current, the patient is placed on a table or seated in a chair as

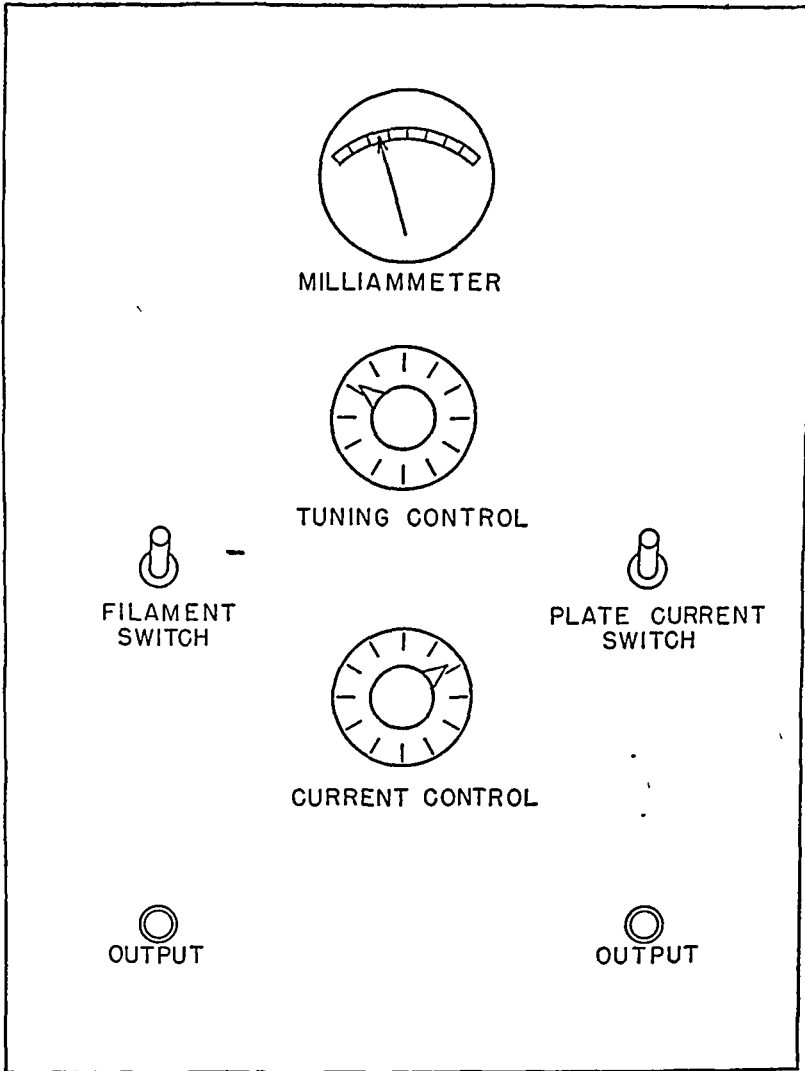

FIG 80. Panel board of short wave diathermy apparatus (schematic).

desired. The condenser electrodes are applied as required. These are then connected to the machine by attaching their cords to the two *output* posts. The current *control* knob is turned so that a minimum of current energy is employed. The *filament switch* is then turned on. After about fifteen seconds, when the filaments have become hot, the *plate current switch* is turned on. Adjustment of *tuning control* will indicate when the maximum point of current flow has been reached as shown on the direct current *milli-*

*ammeter* The current control knob can then gradually be adjusted to higher levels, with retuning if necessary to make certain that the maximum current energy tolerated is being delivered as indicated by the direct current milliammeter

## PHYSIOLOGY

### EXPERIMENTAL DETERMINATIONS OF TEMPERATURE

*Temperature Determinations in Excised Tissue* A bovine thigh was heated by long and by short wave diathermy. With long wave diathermy the temperature distribution was far from uniform. Near one electrode it rose much more than near the other, because of a thick layer of fascia. The bone and marrow did not become heated. The temperature in the fascial layers between the muscles was higher than in the neighboring muscle tissue. The reason for these differences lies in the variations in conductivity between fascia, muscles, and bone. With short wave, on the other hand, the heat produced in muscle and fascia was essentially the same. The temperature of the bone was also raised to practically the same level, while the marrow remained somewhat cooler. The layer of fat surrounding one half the section was not heated unduly in the short wave field, whereas if it had been possible to pass diathermy in the same direction, this fat would have been burned. (In this preparation, there was no skin covering this fat.) These observations indicate that on the basis of the physical characteristics of the currents and of animal tissue, it should be possible to exert a more uniform heating effect on the tissue lying beneath the surface of the body by means of short wave than by diathermy.

*Temperature Determinations in Living Human Tissue* We have conducted numerous experiments to demonstrate the effect of short wave currents applied to the thigh of living human subjects (Fig 81). Living tissue differs greatly from dead tissue in that it possesses a rapidly circulating fluid which can carry heat away from the region where it is produced. The most direct way of determining the actual temperature produced within tissues is by thermocouples. The technique which we employed consisted in the application of cuff electrodes above the knee and as high up on the thigh as was compatible with comfort. Determinations of cutaneous, subcutaneous, and intramuscular temperatures were made before and after application of the short wave current. Substantial elevations of temperature were developed within the intramuscular area as well as in the subcutaneous region and on the skin surface. Equally high temperature readings were obtained when a cable electrode was wound around the thigh. The parallel



electrode technique resulted in comparatively slight elevations of temperature of the tissues lying between the plates.

In our experiments on the living human subject we used felt pads to

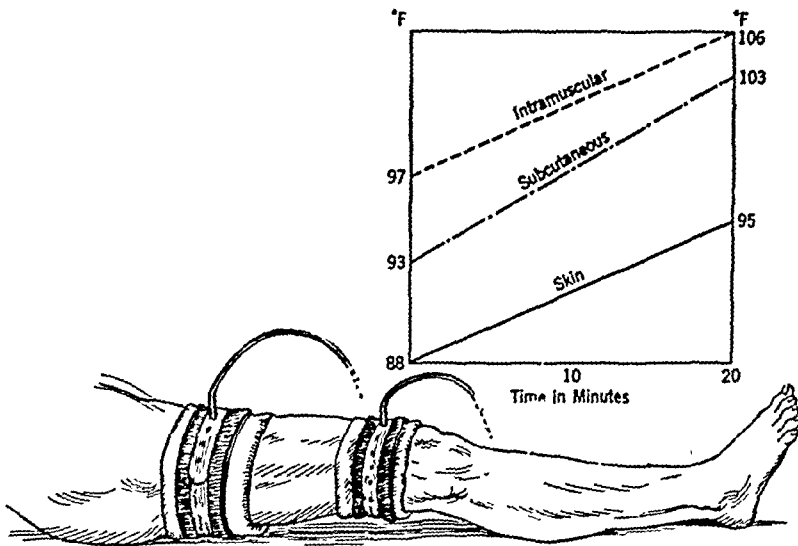

FIG. 81. Temperature changes occurring between cuffs in living human thigh (schematic).

separate the condenser electrodes from the skin surface. We found that if the felt became saturated with sweat during the treatment, the subject complained of an uncomfortable degree of heat, and that the depth temperatures, when taken by thermocouples, were comparatively low. On placing a thin layer of oiled silk between the skin surface and the felt pad, we were able to utilize greater amounts of current with increased heating at a depth and diminished heating on the skin surface. The moistening of the felt by sweat diminished the dielectric effect. The presence of sweat between the oiled silk and the skin did not interfere with effective heating.

In testing a number of machines which produced currents of wavelengths varying from 6 to 18 meters, we found no substantial difference in the degree to which they heated living tissues at a depth. (Coulter and Osborne have made similar observations.) We found, however, that in order to secure good heating effects the spacing between the condenser electrode and the skin surface must be adjusted to the wavelength: it was necessary to hold the condenser electrodes at a greater distance from the skin surface with the shorter wavelengths than with longer wavelengths.

*Pelvic Heating.* With orificial electrodes it is possible to raise the temperature of the tissues in the pelvis. This can be accomplished in the male with a rectal electrode and in the female with a rectal or vaginal electrode. The

temperatures produced resemble those obtained with diathermy. In both instances the height of the temperature elevation is limited to the tolerance of the tissues. As in the application of diathermy, we observed that if the current energy was not increased, the maximum temperatures were not sustained. We found that the best results are obtained with a metal vaginal electrode (Figs 82, 83).

In 1932 Schwarschild and Bierman first reported the use of bare metal orificial electrodes in pelvic heating with the short wave current. With their procedure, the second electrode can be placed on any other part of the body. It was found that the degree of heating obtained depended to an extent on the length of the cord connecting the vaginal electrode to the short wave apparatus, for example, with one apparatus the best results were secured with a cord four feet long. If the most effective cable length for optimum heating is not known for a given machine a variable condenser may be placed in series with the electric cable attached to the metal vaginal electrode.

Experiments with glass condenser vaginal electrodes showed them to be comparatively ineffective. The patients complained of discomfort, the temperature developed was relatively low, and occasionally burns were produced.

A mercury thermometer inserted into a channel within the electrode makes it possible to secure some idea of the temperature values achieved within the adjacent tissues. Horowitz and Bierman fashioned special vaginal electrodes based on plaster casts made in the living human being. The following temperatures were developed as a result of the application of the short wave current with such electrodes.

Vagina	106.3° F
Rectum	106.1° F
Bladder	106.0° F
Cervix	106.2° F

Other techniques employed to cause elevation of pelvic temperature, such as the placing of an electrode on the abdomen and another against the buttocks, or the placing of one electrode against the perineum and the other on the abdomen, did not cause any substantial elevation of temperature within the pelvis. We have found that the diathermy current applied with similar techniques also proved comparatively ineffective.

*Nasal and Paranasal Heating* We have also conducted investigations to determine the degree of temperature elevation that can be produced in certain parts of the head by means of the short wave current. In the tech-

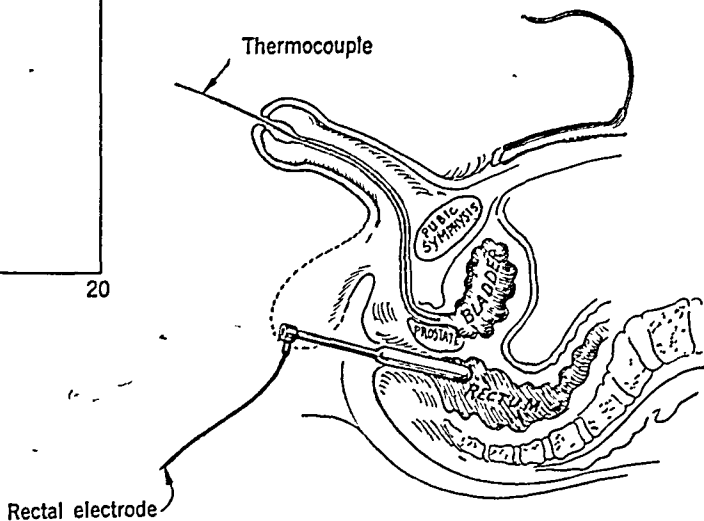
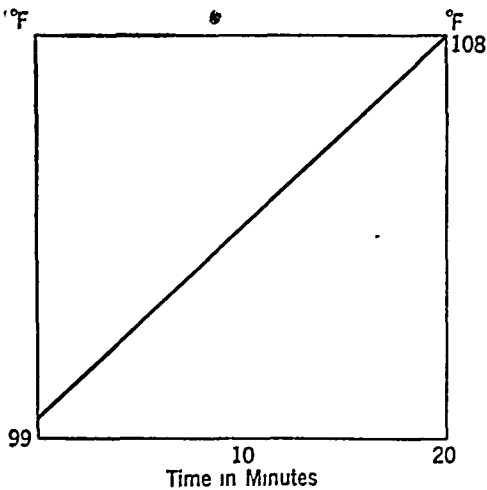

FIG. 82. Temperature changes in the male posterior urethra The metal electrode is placed in the rectum and the condenser pad on suprapubic region. The thermocouple is inserted into posterior urethra. Temperature is determined prior to and following the treatment. The line connecting these two temperatures indicates the sharp increase (schematic).

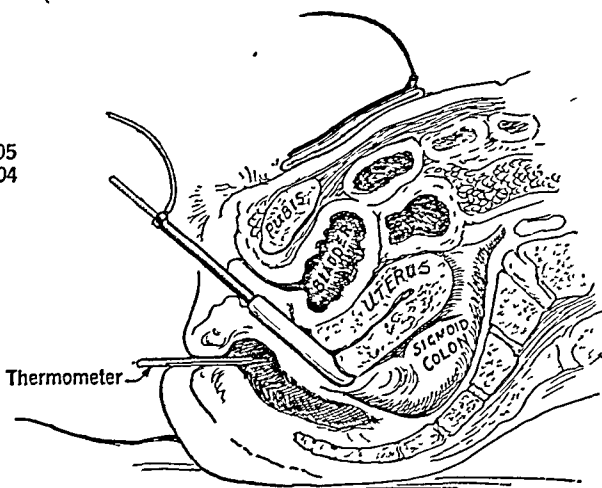
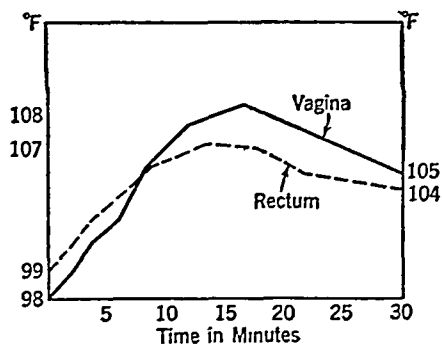

FIG. 83. Temperature changes in vagina and in rectum as a result of application of short wave current with suprapubic and intravaginal electrodes. Thermometers are inserted into the vaginal electrode and into the rectum (schematic).

nique employed one condenser electrode was placed on the face and the other on the region of the back or on the buttocks. The temperatures of the intranasal region of the middle turbinate, the antrum, and the sphenoid

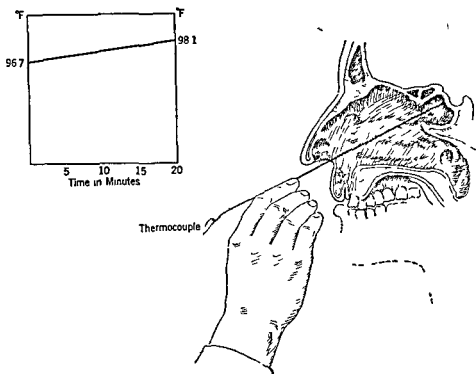

FIG 84 Temperature changes in sphenoid sinus. The thermocouple is within the sinus (schematic)

were determined by a special thermocouple before the short wave current was applied, and again after a ten minute period of application. No readings were made while the current was flowing. The results showed that the temperature of the intranasal, antral, and sphenoid spaces can be only slightly elevated by means of the short wave current. Indeed, many of the temperature readings were lower after the application of the short wave current than before. In all of these instances, however, topical application of a cocaine and adrenalin solution had caused an initial lowering of the temperature which was *not* offset by the subsequent use of the short wave current. When the temperature before the treatment was high, as in acute inflammatory conditions and in postoperative cases, the degree of elevation after the application of current was minimal (Fig 84).

*Heating Within the Spinal Canal* Following the application of electrodes arranged in coplanar fashion to the region of the spine, Feitelberg and I found an elevation of the intraspinal temperatures of two to four degrees Fahrenheit.

## SPECIFIC EFFECTS OF THE SHORT WAVE CURRENT

Whether or not any effect other than that of heat is produced on animal tissue by the short wave current is a controversial question. The determinations that we have thus far made lead to the conclusion that the special changes which have been described as taking place in tissues following the application of short wave currents may be attributed to the temperature elevation. However, numerous reports in the literature maintain that the changes produced by the short wave current cannot be explained on a purely thermal basis. Schliephake stated that he was able to kill staphylococci and tubercle bacilli by exposure to the short wave current. He noted changes in surface tension, in viscosity, and in the stability of colloids, which differed from those observed following heating. Reiter maintained that there was an immediate destructive action on the metabolism of malignant cells when they were exposed to currents with a wavelength of 3.4 meters. Izar and Moretti asserted that the micrococcus melitensis was destroyed by a current of 4 meters wavelength and was not influenced by one of 15 meters. Liebesny stated that he was able to destroy actinomyces with a current of 4 meters whereas the 15 meter current proved completely ineffectual. When Pflomm exposed a frog's foot to the short wave field, he observed dilatation of the capillaries with a slowing up and eventual stasis of the circulation. He believed these changes were due to a specific action of the short wave current upon the autonomic nervous system.

A critical review of these and other claims as to the specific non-thermal effect of the short wave current has thrown reasonable doubt upon their validity. The opinion commonly held today is that a special non-thermal effect is not exerted by the short wave current. In the conclusion of a report to the Council on Physical Therapy of the American Medical Association, Mortimer and Osborne state that the burden of proof still lies on those who maintain that these currents produce any biological action other than that due to heat. On the other hand, it is generally agreed that the short wave currents have a so-called specific action in that they cause phenomena which cannot be produced by other physical means. This specific action is based on the preponderance of the displacement current over the ordinary conduction current. Thus, as Weisz demonstrated, it is possible to secure so-called "point heating" effects in solutions composed of substances having different dielectric constants. When mineral oil was placed in a powerful condenser field, the temperature rise was comparatively small, that is, 10.8° F. When, however, a trace of a culture of *B. coli* was added, the temperature rose 86° F. in the same time period. This observation proves that the heating of the solution containing

the bacteria is adequate to raise the temperature of the entire mixture Kowarschik's experiment of killing small fish in ice water by placing them in the condenser field illustrates that it is possible to elevate the temperature of an

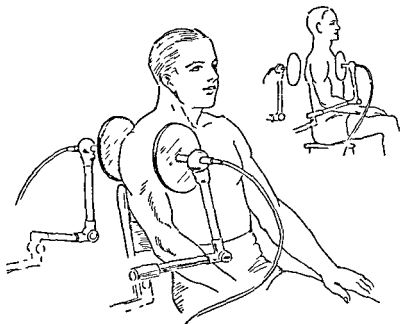

FIG 85 Rigid plate electrodes applied to shoulder anteroposteriorly

mal tissue to lethal levels while the water remains cold Similarly, bacteria may be heated to a higher degree than the temperature of their nutritive medium Drops of water of a water paraffin emulsion begin to boil in the short wave field long before the paraffin has attained a temperature of  $212^{\circ}\text{F}$

These and numerous other experiments demonstrate that the effects produced by the application of the short wave current can be explained by the physiological changes occurring as a result of the heat produced within the tissues This may be true likewise for the so called 'athermal' methods of treatment The fact that the patient is not aware of a definite elevation of temperature is not proof that such elevation does not occur

#### TECHNIQUE

Short wave diathermy can be administered with various devices These include condenser plate electrodes, coil electrodes, drums containing coils and drums with the tank circuit within them, direct metal contact plate electrodes, and orificial electrodes

When using the condenser field technique, the electrodes are usually applied on either side of the region to be treated, parallel to each other (Fig 85) Either flexible or rigid electrodes may be used The rigid electrodes are cov-

ered with some substance like hard rubber, and the flexible ones with some yielding material such as soft rubber or sponge rubber, to diminish the possibility of burns which would occur if the bare metal of the electrodes were touched.

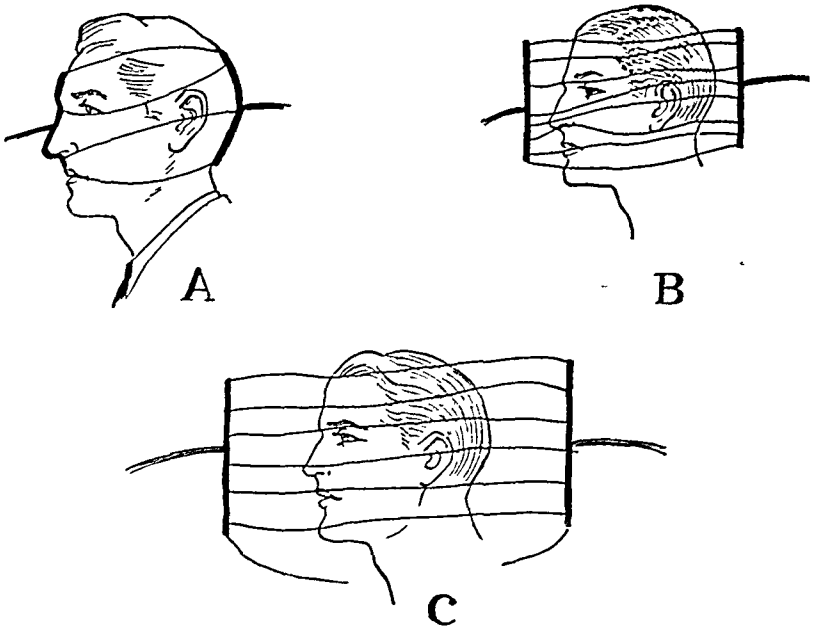

FIG. 86. Current flow through head (schematic). *A.* Contact electrodes. Note reduced current density in nose. *B.* Spaced electrodes, insufficient spacing. Note concentration in nose region. *C.* Spaced electrode, sufficient spacing. Note uniform current density.

Rigid electrodes are held in place by means of supports. They are separated from the skin surface by an air space, the width of which may be varied. Air spacing permits the temperature of the surface of the area treated to remain low in relation to that of the tissues at a depth, because of the cooling effect of the surrounding air. When rigid electrodes are held parallel to each other and applied to an area where there is protrusion of a part, such as the nose and the face, there is danger of a concentration of current energy on those parts which are nearest to the electrode. However, this danger is less with the short wave current than with other methods of conversive heating. It is best to arrange the electrodes so as to avoid marked irregularities of the surface which bring some regions much closer to the electrode than others (Fig. 86). These electrodes may also be placed at right angles to each other; for instance, one against the plantar aspect of the foot and the other back of the calf (Fig. 87). Or, they may be put in the same plane on one surface of the treated region.

When using rigid electrodes on the body, the patient may be seated on a

disadvantage that they become heated themselves, with consequent waste of energy and discomfort to the patient if they come in contact with the skin. The weakest point in the construction of many of these electrodes appears to

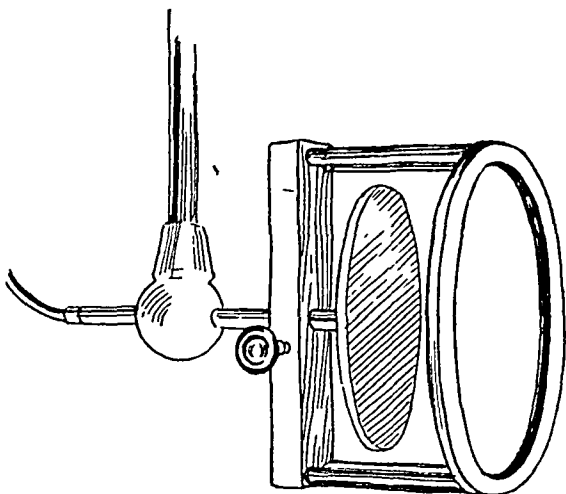

FIG. 88

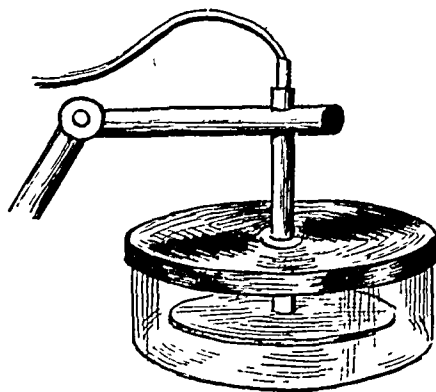

FIG. 89

FIG. 88. Plate electrode with guard. The metal is covered with insulating material.

FIG. 89. Schliephake electrode with glass shoe. Distance of metal plate is adjustable.

be the junction between the electrode cable and the metal plate. We have seen these pull apart with consequent arcing and burning of the insulating material. In these instances the odor of burning rubber has given sufficient warning to prevent thermal injury to the patient.

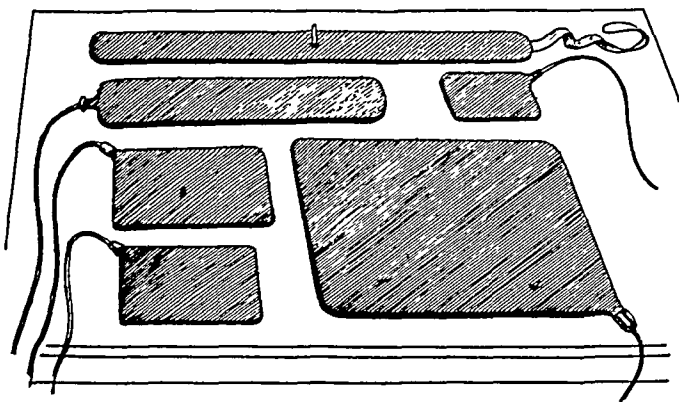

FIG. 90. Various sizes and shapes of flexible plate electrodes.

Flexible electrodes are made in many shapes, most commonly in the form of rectangles or squares with rounded corners. They may be had in various sizes. Those which we use most frequently for local applications are 9 by 12 cm. or 15 by 20 cm. Flexible electrodes may also be circular, or of special



they are for particular purposes, is in the treatment of paronychia. Special butterfly shaped electrodes have been constructed to cover the frontal, nasal, and mental areas without including the region of the eyes (Fig. 99).

In general, electrodes should be of sufficient size to cover the area to be heated. The relationship between the size of the electrode and the size of the area treated is a very important one. If the electrode is larger than the cross section of the mass treated, a concentration of current occurs, if it is smaller, the current is diffused.

The size of the two electrodes need not be the same. If, for example, the condition to be treated is on one surface of the body, this region may be covered by a small electrode while a larger one is placed on another portion of the body. The smaller electrode is usually called the "active," the larger the "inactive" inasmuch as the total current is just as great in the area of the larger electrode although more widely scattered, a more descriptive term would be 'dispersive'. The term 'inactive' implies total absence of any electrical phenomenon in the immediate vicinity of the electrode, which is not the case.

An important point in technique of short wave applications is the relative positions between parts to be heated and the electrodes. When employing rigid or flexible condenser plates, we have observed that an efficient method of creating heat within a desired region is to place the electrodes on the same surface rather than on opposite surfaces, the inner surfaces of the plates should be held parallel to each other. We have called this procedure the "explains technique". The electrodes may be disposed so that the current flows longitudinally or transversely (Fig. 91). In the former instance, the term "longitudinal explains technique" is applied. We have found the unilateral arrangement to be of value in the treatment of such conditions as arthritis of the spine and inflammation in the region of the sacro iliac joint. If the area to be treated, as for example the entire spine, is longer in extent than the largest dimension of the electrode, the longitudinal technique should be employed (Fig. 92). If the portion to be treated is shorter, either explains technique may be used. If the electrodes are transverse to each other, the depth effect will be relatively slight. The considerations of spacing distance and of material are the same as in other forms of electrode application.

#### UNIT PREPARATION

Our electrodes vary in size. Their width may be about 5.5 cm., their length may extend from 30 to 60 cm. The circumference of the treated region determines the length to be used. Overlapping of the electrode does no harm. As

disadvantage that they become heated themselves, with consequent waste of energy and discomfort to the patient if they come in contact with the skin. The weakest point in the construction of many of these electrodes appears to

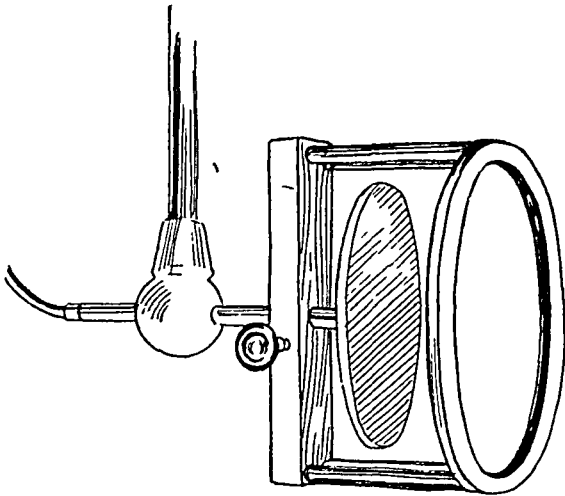

FIG. 88

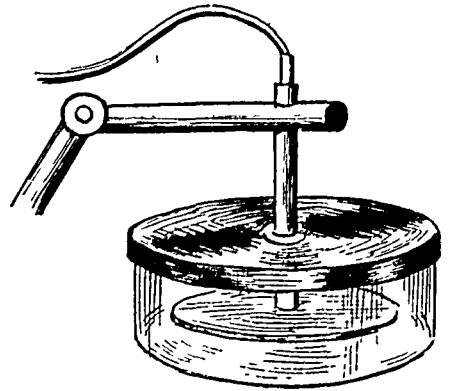

FIG. 89

FIG. 88. Plate electrode with guard. The metal is covered with insulating material.  
 FIG. 89. Schliephake electrode with glass shoe. Distance of metal plate is adjustable.

be the junction between the electrode cable and the metal plate. We have seen these pull apart with consequent arcing and burning of the insulating material. In these instances the odor of burning rubber has given sufficient warning to prevent thermal injury to the patient.

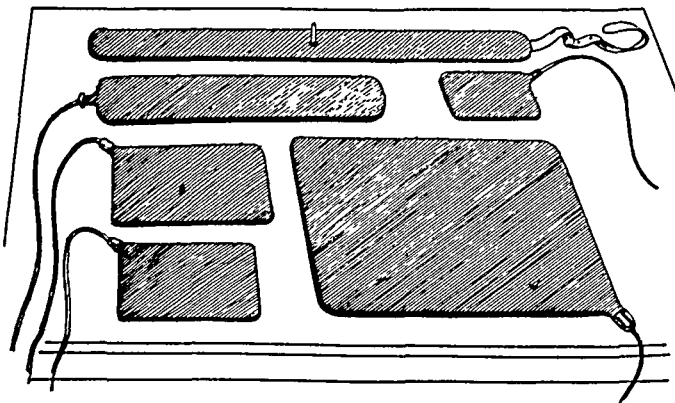

FIG. 90. Various sizes and shapes of flexible plate electrodes.

Flexible electrodes are made in many shapes, most commonly in the form of rectangles or squares with rounded corners. They may be had in various sizes. Those which we use most frequently for local applications are 9 by 12 cm. or 15 by 20 cm. Flexible electrodes may also be circular, or of special

shapes for particular purposes, as in the treatment of paranasal sinusitis. Special butterfly shaped electrodes have been constructed to cover the frontal, nasal, and antral areas without including the region of the eyes (Fig 90)

In general, electrodes should be of sufficient size to cover the area to be heated. The relationship between the size of the electrode and the size of the area treated is a very important one. If the electrode is larger than the cross section of the mass treated, a concentration of current occurs, if it is smaller, the current is diffused.

The size of the two electrodes need not be the same. If, for example, the condition to be treated is on one surface of the body, this region may be covered by a small electrode, while a larger one is placed on another portion of the body. The smaller electrode is usually called the "active," the larger the "inactive." Inasmuch as the total current is just as great in the area of the larger electrode, although more widely scattered, a more descriptive term would be "dispersive." The term "inactive" implies total absence of any electrical phenomenon in the immediate vicinity of the electrode, which is not the case.

An important point in technique of short wave applications is the relative positions between parts to be heated and the electrodes. When employing rigid or flexible condenser plates, we have observed that an efficient method of creating heat within a desired region is to place the electrodes on the same surface rather than on opposite surfaces, the nearest edges of the plates should be held parallel to each other. We have called this procedure the "coplanar technique." The electrodes may be disposed so that the current flows longitudinally or transversely (Fig 91). In the former instance, the term "longitudinal coplanar technique" is applied. We have found the unilateral arrangement to be of value in the treatment of such conditions as arthritis of the spine and inflammations in the region of the sacro iliac joint. If the area to be treated, as, for example, the entire spine, is longer in extent than the largest dimension of the electrode, the longitudinal technique should be employed (Fig 92). If the portion to be treated is shorter, either coplanar technique may be used. If the electrodes are too close to each other, the depth effect will be relatively slight. The considerations of spacing, distance and of material are the same as in other forms of electrode application.

#### CUFF ELECTRODES

Cuff electrodes vary in size. Their width may be about 5.5 cm, their length may extend from 40 to 60 cm. The circumference of the treated region determines the length to be used. Overlapping of the electrode does no harm. As

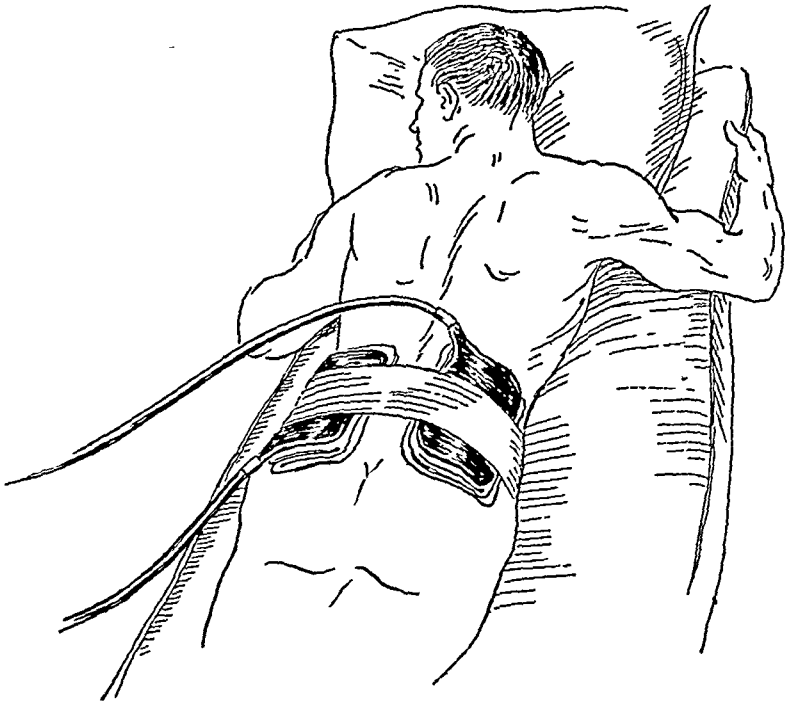

FIG. 91. Transverse coplanar technique in sacro-iliac region.

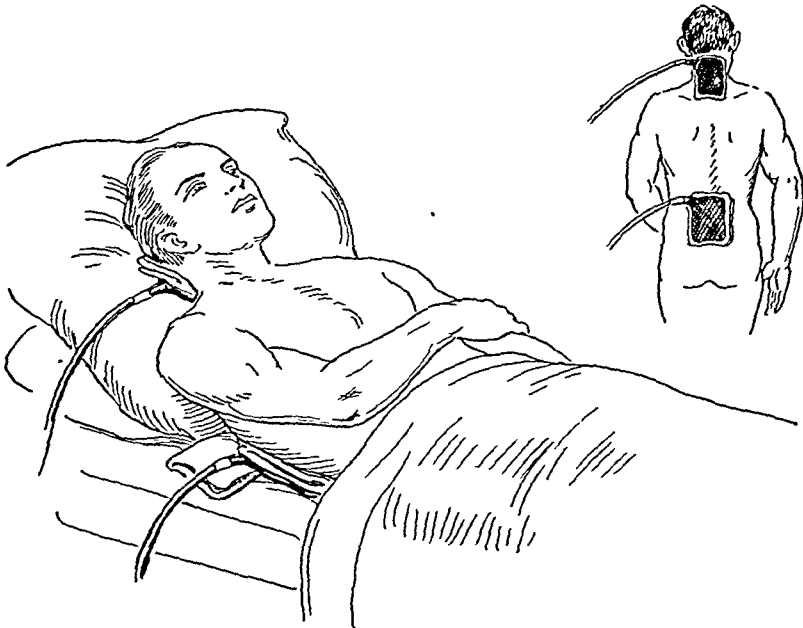

FIG. 92. Longitudinal coplanar technique for spine.

with the condenser plate electrode, cuff electrodes are covered with some insulating material such as rubber. Cuff electrodes are applied chiefly to the extremities. Relatively intense heating of the tissues lying between the cuffs

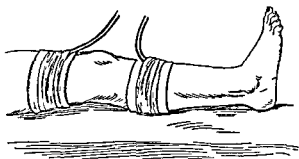

FIG 93 Cuff electrodes above and below knee, held in place by rubber bandages

occurs, because of the convergence of the electric field within the tissue. In conditions in which a high degree of heat is undesirable, cuffs should not be used. In some areas, as, for example, the inner side of the knee, partially encircling cuffs are adequate. The technique is essentially the same as when flexible condenser electrodes are placed in the coplanar position and then bent somewhat to accommodate themselves to the contour of the part (Fig 93).

#### COIL ELECTRODES

With the coil electrode technique it is possible to develop very effective heating within the tissues. This heating probably results from the electric field as well as from the magnetic field. Merriman, Holmquest, and Osborne were the first to describe this procedure. The coil is wrapped around the portion of the limb to be treated with several turns of the cable, usually three or four. The windings should be held as equidistant as possible from the skin surface and from one another. The induction cable is held away from the skin surface by the interposition of toweling, which should be sufficiently thick to give a spacing of from one quarter to one half inch. For the torso the cable may be applied in the form of a long U. Wooden spacers help to keep the coils equidistant from one another (Figs 94, 95, 96).

*Pancake Coil* The pancake coil may be enclosed within a drum (Fig 97). This permits of easier manipulation. Drums have also been constructed which hold the tank circuit. The small wattage employed causes a minimum of interference with radio communications (Fig 98).

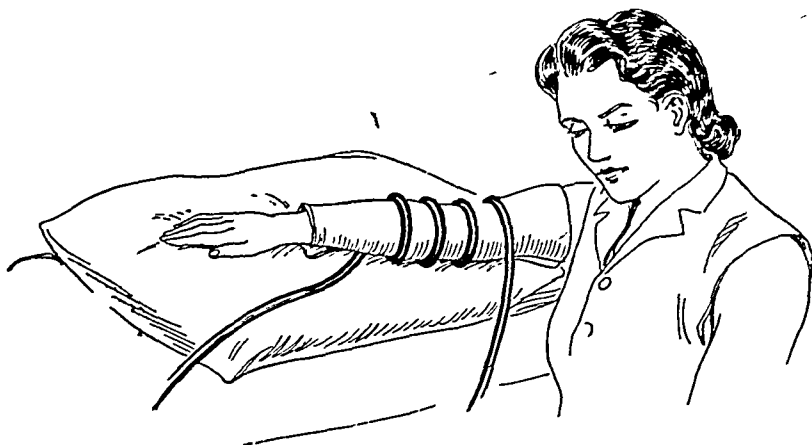

FIG. 94. Coil applied to arm.

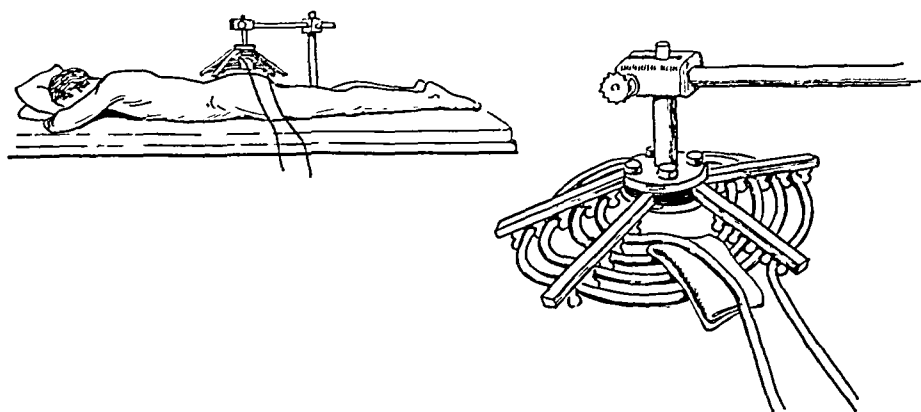

FIG. 95. Cable within adjustable holder, applied to region of buttocks.

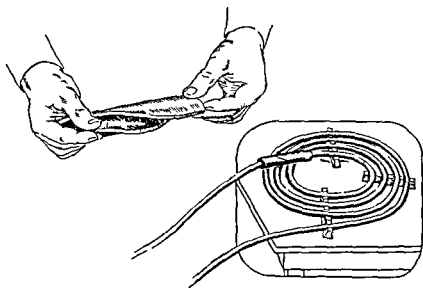

FIG 96 Arrangement of coil showing rubber guard placed on the cable crossing the coils This prevents contact of parts of cable.

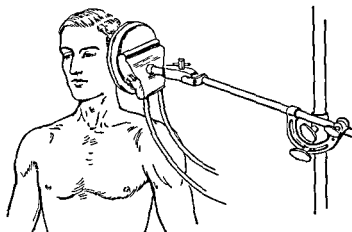

FIG 97 Coil within drum electrode applied to face.

## DIRECT CONTACT ELECTRODES

With a suitable circuit metal electrodes for short wave applications may be placed in direct contact with the skin surface, as in long wave diathermy (Fig. 99).

## ORIFICIAL ELECTRODES

Orificial electrodes offer the most convenient method for heating the body cavities. Bare metal electrodes are more efficient than those surrounded by some insulating material. These electrodes may be connected to the machine directly or through a variable condenser (Fig. 100).

Still another technique which has been described may be referred to as a uniterminal one. In this, only one electrode is used. It is placed over the region to be influenced, and connected to one terminal of the machine. The body possesses a considerable capacity in relation to its environment. The circuit may be completed through objects in the vicinity. The action of this current is essentially superficial. It has been described by Groag and Tomberg.

## ELECTRODE SPACING

In spacing electrodes, the distance between the electrode and the skin surface, and the nature of the intervening material are important. There exists an optimum spacing for each machine. In general, the longer the wavelength the shorter the spacing distance required. Too great a spacing distance causes marked diminution in the amount of energy which can be delivered. It has been stated that to obtain homogeneous heating at a depth, the electrodes must be held at a distance from the surface to be treated. The thermal effect on deeply situated tissues is determined by the relationship between the size of the condenser electrode and the size of the region to be heated. Increasing the skin-electrode distance has the same effect as applying a larger electrode nearer to the skin surface. Therefore, with relatively greater spacing a relatively greater influence is exerted on deeply lying organs. If it is desired to treat a superficial lesion, the spacing distance should be small. With short spacing, the current concentration is essentially in the region of the skin beneath the electrode. In general, the spacing distance for surface effect should not be less than 1 cm. nor more than 5 cm., unless one desires to apply the so-called relatively athermic technique, in which case the distance may be made larger.

Various materials may be interposed between the skin surface and the condenser electrode. These substances have different dielectric values. The



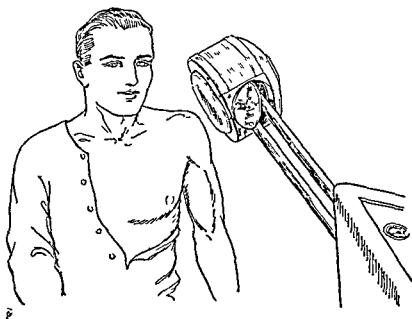

FIG 98 Apparatus with tank circuit in drum

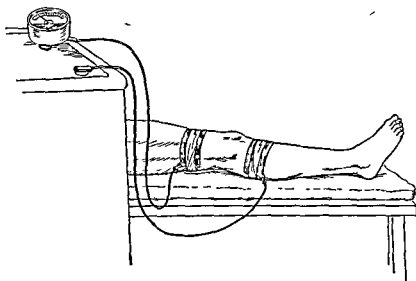

FIG 99 Metal direct contact electrodes with meter inserted

## DIRECT CONTACT ELECTRODES

With a suitable circuit metal electrodes for short wave applications may be placed in direct contact with the skin surface, as in long wave diathermy (Fig. 99).

## ORIFICIAL ELECTRODES

Orificial electrodes offer the most convenient method for heating the body cavities. Bare metal electrodes are more efficient than those surrounded by some insulating material. These electrodes may be connected to the machine directly or through a variable condenser (Fig. 100).

Still another technique which has been described may be referred to as a uniterminal one. In this, only one electrode is used. It is placed over the region to be influenced, and connected to one terminal of the machine. The body possesses a considerable capacity in relation to its environment. The circuit may be completed through objects in the vicinity. The action of this current is essentially superficial. It has been described by Groag and Tomberg.

## ELECTRODE SPACING

In spacing electrodes, the distance between the electrode and the skin surface, and the nature of the intervening material are important. There exists an optimum spacing for each machine. In general, the longer the wavelength the shorter the spacing distance required. Too great a spacing distance causes marked diminution in the amount of energy which can be delivered. It has been stated that to obtain homogeneous heating at a depth, the electrodes must be held at a distance from the surface to be treated. The thermal effect on deeply situated tissues is determined by the relationship between the size of the condenser electrode and the size of the region to be heated. Increasing the skin-electrode distance has the same effect as applying a larger electrode nearer to the skin surface. Therefore, with relatively greater spacing a relatively greater influence is exerted on deeply lying organs. If it is desired to treat a superficial lesion, the spacing distance should be small. With short spacing, the current concentration is essentially in the region of the skin beneath the electrode. In general, the spacing distance for surface effect should not be less than 1 cm. nor more than 5 cm., unless one desires to apply the so-called relatively athermic technique, in which case the distance may be made larger.

Various materials may be interposed between the skin surface and the condenser electrode. These substances have different dielectric values. The

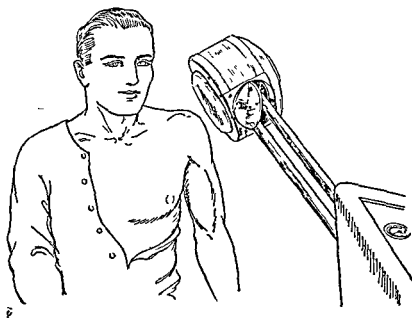

FIG 98 Apparatus with tank circuit in drum

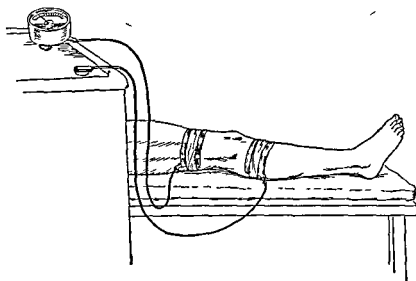

FIG 99 Metal direct contact electrodes with meter inserted

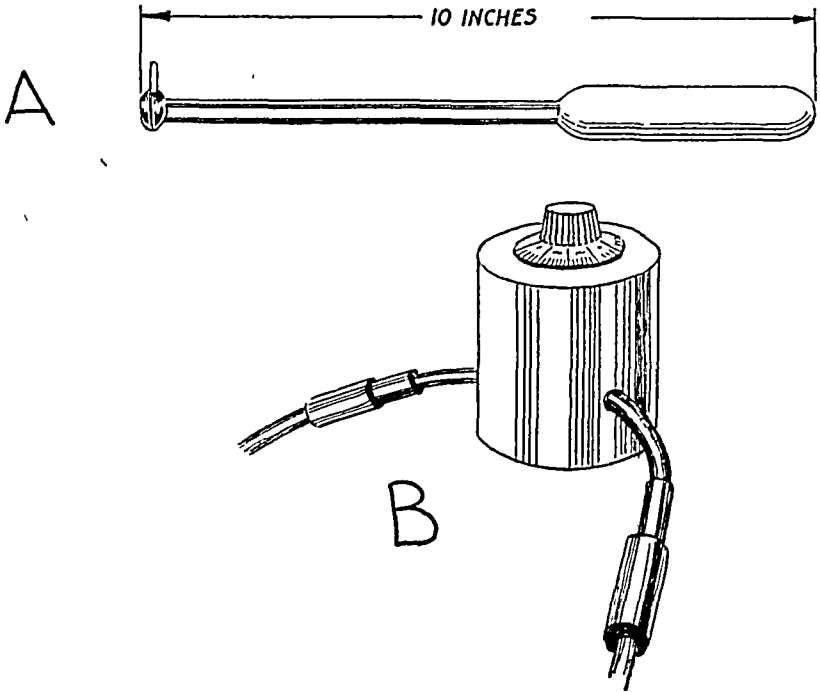

FIG. 100. A. Metal rectal electrode. B. Variable condenser.

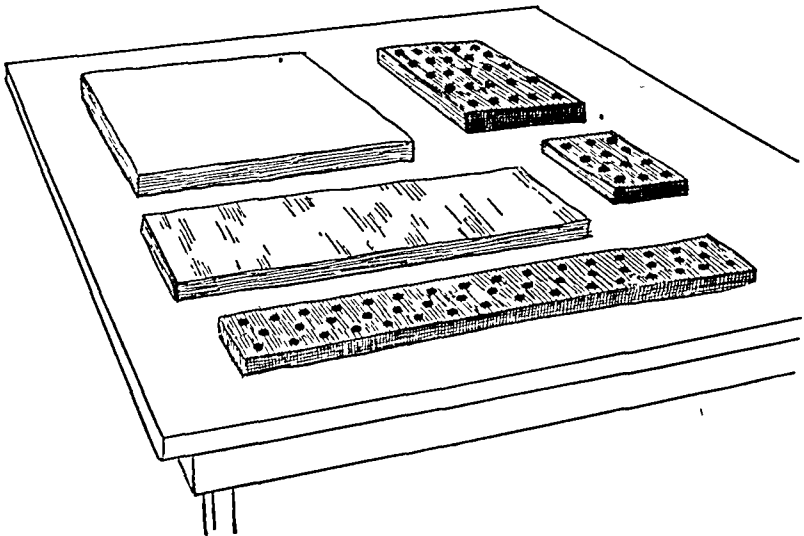

FIG. 101. Felt spacers—solid and perforated

materials ordinarily used have a higher dielectric constant than air, but a much smaller constant than tissue. The most common of them are felt (either solid or with large perforations to incorporate relatively large amounts of air), towels (hand or Turkish), dry gauze, and sponge rubber (Fig 101). When the material is compressible, the spacing distance must be calculated after the material has been compressed. Frequently a combination of materials is used, for instance, felt placed next to the electrode and a layer or two of towels against the skin surface. Or absorbent paper is placed near the skin surface and then a layer of some non absorbent material. The purpose of such arrangements is to remove or to diminish the layer of sweat which may intervene between the skin surface and the electrode. Heat concentration may occur in a layer of sweat, as its chemical content makes it a good conductor. If the intervening material becomes permeated with sweat, the dielectric value of the spacing becomes considerably altered. The area between the region of moisture extending closest to the electrode and the electrode surface becomes narrower, with a consequent production of localized heating in these regions. This current concentration may produce thermal damage. Before this point is reached, the patient, if he is possessed of normal thermal sensibility, will complain of uncomfortable heat. To avoid the possibility of a burn, it is necessary to make frequent inspections of the toweling material applied next to the skin (if this is used), and to substitute a dry towel if required. This precaution is more necessary in warm, moist weather than when the atmosphere is dry and cold.

A thin layer of some substance like oil silk is sometimes placed in immediate contact with the skin to prevent irregularities in the thickness of the sweat layer. Although theoretically it should prove effective, it does not appear to be as satisfactory as absorbent material which can be changed if necessary. It is difficult to keep the waterproof material flush against the skin. However, a layer of foam rubber appears to obviate to a large degree the difficulty resulting from the employment of a sheet of thin material such as oiled silk.

Caution should be exercised in applying the short wave current to the region of open wounds and ulcers, because the irregularity of their surfaces may lead to point heating. If cuff electrodes are used, they should be held equidistant from the surface of the skin. An apparatus utilizing the air as a dielectric has been designed for this purpose. It consists of small wooden supports held together by rods and placed on the edges of the cuff. However, it appears to be simpler to use spacing material such as felt and towels.

The cuff technique has the advantage of permitting greater concentration of current.

#### DOSAGE DETERMINATION

It is difficult to measure the current strength in the patient's circuit. The ordinary hot wire milliammeter is not dependable because only part of the current passes through the meter and because of the variation in energy in different parts of the circuit. Part of the current flowing between the condenser pads does not go through the patient. This portion is referred to as the "wattless component." It varies with the position, shape, size, and spacing of the electrodes, as well as with the frequency of the current. Special instruments have been designed to measure dosage. The amperemeters which are incorporated in some apparatus are of limited value in indicating the point of maximum resonance. The neon lamp provides another relatively crude method of determining current flow; maximum resonance is indicated when the lamp glows most brightly. In view of the limitations to these methods of measuring dosage one must depend on experience gained in the use of a given machine and on the patient's sensations. In the presence of nerve injuries, hysteria, syringomyelia, tabes, and other conditions in which there are sensory disturbances, it is incumbent on the operator to make certain that a temperature sense exists before the current is applied. In the absence of temperature sense, the energy must be applied with extreme caution. The patient should be impressed with the necessity for telling the operator if the area being treated becomes too hot. In certain parts of the body, the sensation of overheating is indicated by the development of a dull ache, as in muscles, or by pain, as in the neighborhood of joints. The latter may be due to periosteal heating.

The quantity of heat produced can be regulated by the operator in accordance with the degree of heat desired; to the point of tolerance, to produce no thermal sensation, or to produce only a sensation of mild heating. When using energy to the point of tolerance, the patient should be impressed with the fact that a sensation of comfortable heat is adequate. In the belief that if a little heat is good, more is better, some patients will attempt to tolerate heating so vigorous as to produce burns. The analgesic action of the current and the compression of the tissues between an unyielding table on one side and a bony prominence on the other may interfere with the proper appreciation of a sensation of overheating. The physician can gain some idea of the temperature of the surface of the part to be treated by momentarily discontinuing the treatment and placing his hand on the region.

## DURATION AND FREQUENCY OF TREATMENT

The duration of the application of short wave current depends on the condition to be treated. In acute conditions, and early in a course of treatments, when the degree of reaction is uncertain, a small amount of energy should be applied for about ten minutes. Occurrence or aggravation of pain indicates that the current is too strong or has been applied for too long a time, or that it should not have been administered at all. The average duration of treatment is about twenty minutes, this may be extended to thirty or forty minutes. In fever therapy, treatments may extend over a period of many hours.

The frequency of treatments also depends on the nature of the disease to be treated. At the beginning, applications are usually made every day or every other day. Later on, the intervals are increased. Occasionally a treatment may be repeated during the same day.

## THE WAVELENGTH

The length of the wave in the range usually employed appears to have but little influence on the degree of heating produced within the tissues. To obtain elevation of general body temperature, wavelengths of 15 to 30 meters may be the most efficient, because at these frequencies a greater percentage of the input energy can be secured from the apparatus, and the efficiency of the tubes is greater. For the treatment of acute inflammations, many authors appear to favor the use of wavelengths of 6 meters or less.

## PREPARATION OF THE PATIENT AND PRECAUTIONARY MEASURES

The patient should be placed in a comfortable position, either sitting or lying down. In the latter instance, a special wooden table (page 153) facilitates the application of the electrodes. While it is possible to apply heat through clothing, it is better to remove the clothing from the affected part. This permits direct observation of the skin and also the removal of the interposed material which may become moist from perspiration, and the substitution of a dry layer. Wet dressings, if present in the region, may become very strongly heated by the flow of current. They should therefore be removed before administering the treatment. Ointments, likewise, should be removed. Dry dressings may be permitted to remain in place. Metal objects, such as hairpins, earrings, buttons, watches, and the like, may help to concentrate the field and bring about local overheating, and therefore they should be removed. According to Kowarschik, metal wires and bone

fragments may become heated if they lie parallel to the direction of the field. Metal fillings in teeth, however, do not appear to cause any difficulties. Care should be taken to see that the cable connecting the electrode to the machine is not permitted to lie in contact with any part of the body surface. Some non-conducting material should be interposed between the cable and the skin surface; otherwise the large amount of heat produced on the surface may cause a burn. We have observed that overheating may occur in skin which is in contact with oilcloth. Kobak reported that art leather and old rubber mats may cause a similar difficulty.

If the patient is not provided with means to turn off the current, the doctor or nurse should remain in the immediate vicinity, to turn off the current if the patient complains of undue discomfort. During treatments through the region of the head, the current should be turned off if the patient complains of dizziness or of headache. At frequent intervals, the patient should be asked how he feels and whether the application is becoming too hot. Often a specific question will elicit information indicating the advisability of reducing the current or of changing a layer of material which has become moist, when the patient might not have volunteered this information spontaneously. Frequently a patient falls asleep while under treatment. Under such circumstances, it becomes necessary for the operator to reassure himself, by inspection of the settings on the machine, by observing the posture of the patient, and by determining whether the interposed material is wet, that the patient is not in danger of receiving a burn. If there is any doubt whatever, it is far better to deprive the patient of a few minutes' sleep than to run the risk of the much greater discomfort of a burn.

Some machines are so constructed that the plate current cannot be turned on before the filament current is operating. When a filament voltage indicator is present, the current should be adjusted so that the meter indicates the proper voltage. After the plate current has been turned on, the patient's circuit is tuned to resonance. This is indicated when the needle reaches its highest point on the meter. If there is too much current in the patient's circuit it is better to adjust the input of the machine rather than detune the circuit. At the conclusion of the treatment, one should make certain that the filament current, as well as the plate current, has been turned off. It is not conducive to the long life of these tubes if the filament current is permitted to remain on for many hours.

The patient should be cautioned not to touch the electrode while the current is on because of the danger of burning his fingers, and because such a contact may distort the field. Before the administration of the first treat-



ment the patient, particularly if he is an apprehensive type, should be assured that the application is a pleasant one, evoking an agreeable sensation of heat. He should be told further that if any disagreeable sensation occurs, the operator should be informed so that necessary adjustments may be made.

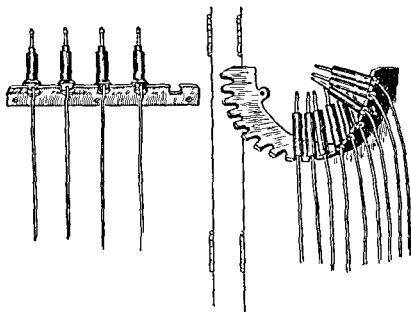

FIG. 102 Racks for hanging electrodes. The back of a door is a convenient place for the rack.

Directly after the current is turned on, the operator should note the time in order to gauge the duration of the treatment. A time clock with a bell which rings at the end of the treatment is of value, particularly when several patients are being treated at the same time. Another method of keeping track of the duration of the treatment is to make a note of the time of its beginning, or better still, of the time at which the session is to end. Some machines are equipped with an electric time switch which shuts off the current automatically.

At the completion of a treatment, flexible electrodes should be placed in such a position that they will remain flat until they are used again. If thrown down carelessly, they may become misshapen and so distort the field when used subsequently, or the wire in the cable may break at its junction with the electrode (Fig. 102).

Brunner has devised an apparatus to be used in conjunction with the short wave machine to permit the heating of two areas at the same time. One terminal of the short wave machine is connected directly to a large condenser electrode placed on the patient, the other is connected to the distributor from which two cords go to two smaller electrodes. Variable

condensers in the apparatus permit separate tuning of the two circuits. The special techniques for the application of the short wave current to various parts of the body are, in general, much like those discussed in the section on long wave diathermy (Chapter V).

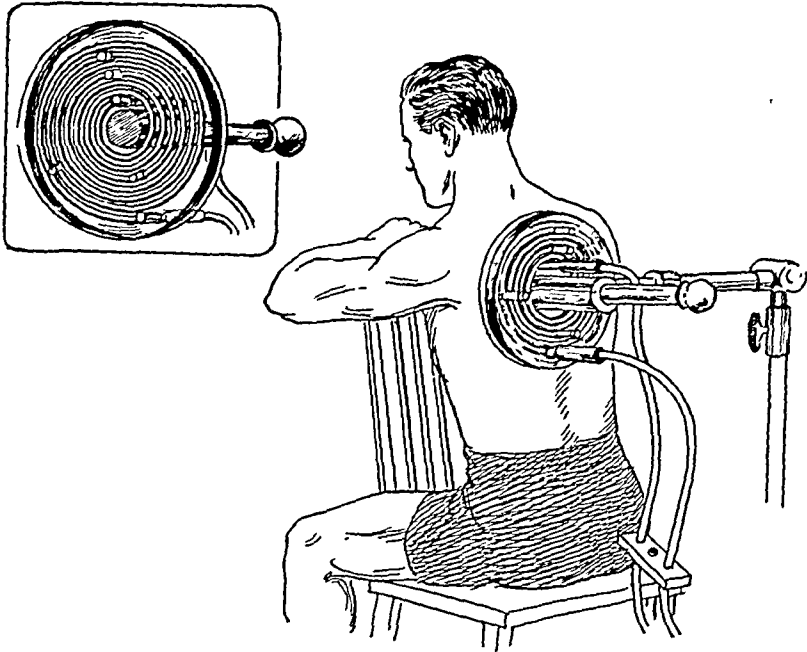

FIG. 103. Coil held within transparent plastic drum, applied to upper back.

#### INDICATIONS

The ability of the short wave current to produce heat relatively deeply within the structures of the body makes this current especially valuable when the production of active hyperemia is desired. The types of cases in which clinical improvement may be effected by means of this conversive energy are discussed in detail in Part II, in relation to the various diseases. In general, shorter durations and weaker intensities of short wave currents are employed in the treatment of acute inflammatory states; longer durations and stronger intensities in chronic inflammations. Short wave diathermy has a therapeutic place in the symptomatic treatment of subacute and chronic arthritis, both atrophic and hypertrophic. As a therapeutic fever-producing procedure, it is valuable in gonorrhoea, and for local heating of involved joints. The residual pathological effects of gonorrhoeal arthritis can be effectively treated by conversive heat in conjunction with other therapeutic measures. As in other traumatic conditions, the active hyperemia produced by the short wave current hastens the removal of extravasated lymph and

blood and expedites the restorative processes after the occurrence of a traumatic arthritis. Soft tissue injuries rapidly improve through the employment of this agency, whether they occur by themselves, or with fractures or dislocations (Fig 103). After the first twenty four or forty-eight hours during which time cold may be more serviceable, the short wave current hastens healing in sprains and similar injuries. Inflammations of bursae about the shoulder joints and at other parts of the body may be treated by cold during the early stages, followed later by conductive heating measures and then by the *conversive energy* of the short wave current. During the acute stages of bursitis, the effective deep heating by this current may increase pain and swelling (Fig 104). Inflammations of fibrous and muscular tissues, such as fibrositis, myositis, myofascitis, tenosynovitis, are greatly helped by the use of *conversive heat* in conjunction with other measures. Short wave current heating has a place in the general therapy of bronchitis, bronchial asthma, and pneumonia. Stimulation of the peripheral circulatory system is of value in arteriosclerosis, and in some cases of thromboangitis obliterans when cautiously applied. To diminish hypertony, it is advocated in diseases of the gastro-intestinal tract, such as esophageal spasm, cardiospasm, pylorospasm, spastic conditions of the gall bladder and bile ducts, and constipation.

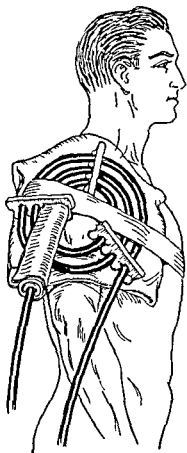

FIG 104 Coil around region of shoulder

Acute gonorrhoeal infections of the genito urinary tract in both sexes can be dramatically improved by local heating in conjunction with elevation of the temperature of the entire body. In the care of the chronic stages of these diseases, the short wave current plays an important part.

Pain occurring along the distribution of nerves as in so called "brachial neuralgia," sciatica, intercostal neuritis, and trigeminal neuralgia may be ameliorated by the sedative action of this current.

The short wave current may be used to abort or hasten resolution in local infections. In areas of suppuration, drainage should be established before this or any other form of heat is applied. This holds true for the treatment of furun-

cles, carbuncles, osteomyelitis, adenitis, and the like. The physical advantages of the technique of applying the short wave current permit its ready application to the eye, ear, nose, throat, and paranasal sinuses when these parts of the body become involved in chronic inflammations.

It is possible to use the short wave current to cut through tissue. However, its relatively poor coagulating power makes its use inferior to surgical diathermy for most surgical purposes.

#### CONTRAINDICATIONS

In general, the same pathological states that make it inadvisable to apply other forms of heat contraindicate the use of the short wave current. The problem may be considered one of thermal dosage. In some conditions mild and brief treatments may be of definite value, while those of greater intensities and durations may cause damage. In acute inflammations, such as acute bursitis and acute arthritis, it may be best to avoid all forms of heat. With the subsidence of the acute stage, mild short wave treatments may be administered. In the presence of confined pus, this current should not be applied. The active hyperemia produced by this agency may aggravate a tendency to bleeding; therefore it should be avoided when the danger of excessive bleeding exists, as in recent cerebral hemorrhage, in hemoptysis and hematemesis, and during menstruation. For the same reason, it should not be applied to areas in which a new growth exists, and in pregnancy. As thermal response changes when local circulation is impaired, the energy applied should vary accordingly. If the vascular status is greatly changed, it may be wise to omit short wave therapy. Areas of anesthesia should be treated with caution. If treatment causes an aggravation of symptoms, or development of undesirable ones such as faintness or headache, the dosage should be diminished or the method discontinued.

Short wave diathermy should not replace simpler forms of heating that are equally effective. That so potent an agency as the short wave current is available, is not an indication that other methods of thermal application should be discarded. The different modes of action of these various procedures should be taken into account, and the procedure best adapted to the condition to be treated should be selected. In general, conductive heating measures, such as the hot water bag, the electric pad, the hot compress, and long wave infra-red radiation, heat essentially the superficial layers of the skin. Luminous radiations (including the near infra-red) penetrate through the skin, and, to a lesser extent, cause elevation of temperature of the tissues lying a short distance beneath it. Diathermy heats structures lying deep,

but it does not heat them as uniformly as the short wave current does. Ideally, the practitioner should possess all of these modalities, for he will then be enabled to modulate dosages of thermal energy with a great degree of refinement. He should, however, keep in mind that although the short wave current affords the most potent method now available for heating the body in its various parts, it is only one of many effective remedies in modern medical practice.

#### RADIO INTERFERENCE

Interference caused by diathermy and short wave current machines in radio and television broadcasting has been the subject of active discussion between physicians and manufacturers of medical apparatus, on the one hand, and the officials of radio broadcasting companies and of the Federal Communications Commission, on the other. Solutions of this problem which have been advanced include control of frequency to sharply delimited wave bands, shielding, filtering, and the use of non radiating transmission lines. Some of these measures are very costly, and their adoption may increase the expense of treatments to a level which may place them beyond the reach of the many sufferers in the all too large low income groups. The Federal Communications Commission has allocated three bands for medical purposes. The frequencies are 13.6, 27.3, and 40.9 megacycles (wavelengths of 21.95, 10.98, and 7.32 meters). When all the other causes of radio interference are considered, it may not appear equable to emphasize unduly that coming from medical apparatus. Possibly, continued improvements in radio broadcasting and receiving equipment may render negligible all these sources of interference. Recently, a short wave machine has been constructed in which the tank circuit is contained within a drum which is held close to the patient. This permits the use of small wattage with the consequent limitation of the field to a relatively small distance from the machine. Radio interference is thus avoided except in the immediate vicinity of the apparatus.

#### REFERENCES

- BIERMAN, W., and HOROWITZ, E. A. A new vaginal diathermy electrode. *Arch Phys Therapy* 17 15-16, 1936
- BRUNNER, M., and KRUSEN, F. A modified method for application of short wave diathermy. *Arch Phys Therapy*, 21 16, 1940
- GROAG, P., and TOMBERG, V. Measurements of skin temperatures method of explaining problem of short wave dosage. *Deutsche med Wchnschr* 63 1085-1089, 1937
- IZAR, G., and MORETTI, P. *Klin Wchnschr*, 13 771, 1934

- KOBAK, D., and MITTELMANN, E. Newer aspects of dosage and technic in short wave diathermy. *Arch. Phys. Therapy*, 21 : 87-95, 1940.
- KOWARSCHIK, J. Kurzwellentherapie. Vienna, Springer, 1936.
- KOWARSCHIK, J. Deep action of short waves. *Wien. klin. Wchnschr.*, 50 : 1649-1653, 1937.
- LIEBESNY, P. Kurz und Ultrakurzwellen Biologie und Therapie. Vienna, Urban and Schwarzenberg, 1935.
- MERRIMAN, J. R., HOLMQUEST, H. J., and OSBORNE, S. L. A new method of producing heat in tissues. *Am. J. M. Sc.*, 187 : 677, 1934.
- MORTIMER, B., and OSBORNE, S. L. Short wave diathermy: some biologic observations. *J.A.M.A.*, 104 : 1413, 1935.
- OSBORNE, L., and COULTER, J. S. Thermal effects of short wave diathermy on bone and muscle. *Arch. Phys. Therapy*, 19 : 281-284, 1938.
- PFLOMM, E. Kurzwellenbestrahlung des Rattensarkoms. *München. med. Wchnschr.*, 77 : 1854, 1930.
- REITER, T. Some investigations of the properties of short waves. *Brit. J. Phys. Med.*, 8 : 119-121, 1933.
- SCHLIEPHAKE, E. Kurzwellentherapie. Jena, G. Fischer, 1935.
- SCHWARZCHILD, M. M. In Bierman: The Medical Applications of the Short Wave Current. Baltimore, William Wood, 1938.
- WEISZ, H., PICK, J., and TOMBERG, V. Problem of specific effect of short waves on blood vessels. *Arch. Phys. Therapy*, 19 : 79-83, 1938.

## CHAPTER VII

# FEVER THERAPY

THE CONCEPT OF FEVER THERAPY MAY BE TRACED TO the dawn of written history "Give me the power to produce fever, and I will cure all disease," is an aphorism attributed to Hippocrates. The sweat bath was a favorite therapeutic measure among early Americans, many of whom suffered from arthritis, neuritis, and rheumatism. These painful illnesses were not distinguished from one another, but were all treated with the sweat bath. Caroline Indians used hot mud holes for treating various diseases of the extremities.

The Chinese, and the Japanese who derived their medical practice from China, were among the earliest people to use their intensely hot springs solely for therapeutic purposes. In Japan, these volcanic formations give rise to many hot springs, which became known for their curative effects on syphilis, arthritis, rheumatism, acute genito-urinary infections, and respiratory, nervous, digestive, and ocular diseases. These thermal springs have been popular throughout the Japanese empire since the sixteenth century, and had enjoyed local renown for several centuries before that time. Indeed, the thousands of hot springs in Japan were important sources of cure among all classes of the populace long before the introduction of European medicine, and at a time when the Chinese medicine men still ruled the country. At Kusatsu, water gushes out of the bases of ancient volcanoes at a temperature between 100° and 160° F. As it flows into reservoirs, the water is unbearably hot, and the bathers stir it with large wooden paddles to cool it slightly. Then, they immerse themselves to the neck and pour hot water over their heads with wooden dippers. After three to six minutes of this refined torture, they emerge almost parboiled with a body temperature between 103° and 105° F. This fever continues for some time after leaving the bath. Since these hardy people take from two to five baths a day, a decided and persistent elevation of temperature results. The procedure often leads to a diffuse dermatitis with extensive blister formation. It is one of the most vigorous non specific means of fever production.

In 1883, Phillips conceived the idea of producing a sustained rise in temperature for therapeutic purposes by means of hot baths. He demonstrated by self-experimentation that his temperature could be raised to 103° F. by prolonged immersion in hot water. Recent research in fever and fever therapy is in a large measure the result of work by von Jauregg and Whitney. After twenty years of observation von Jauregg confirmed the numerous early reports, and in 1917 undertook inoculation of parietic patients with malaria on the theory that febrile diseases had a favorable effect on psychoses. It should be pointed out that the beneficial effect of malaria in epilepsy had been known to Hippocrates.

Unlike the fever which follows intravenous injection of typhoid vaccine or of malaria plasmodium, heating energy produced by physical measures is transferred to the body from without instead of being developed internally. The one has been termed a "passive" fever, the other an "active" fever. The relative therapeutic value of these two methods is a matter of discussion; each has its advantages and disadvantages. It is simple to produce fever by injection of some protein or other chemical substance. Physically induced fever requires relatively elaborate and expensive apparatus, special facilities of space, usually within a hospital, and special and continuous nursing care. It has the advantage of providing a temperature when wanted, the level and duration of which can be controlled. This is of incomparable value in a disease like gonorrhoea, in which a proper time-temperature relationship can achieve the destruction of all the invading organisms with a single treatment. On the other hand, the proponents of malarial therapy for the care of central nervous system syphilis maintain that the body's response to it makes this measure therapeutically more satisfactory. Breutsch states that the stimulation of phagocytic plasmatocytes observed in malaria as the result of red blood cell destruction by the plasmodia, provides an important cellular defense weapon in the treatment of syphilis of the nervous system which is not available in other fever methods. Doan, however, found that while sternal marrow biopsies do not show an increase in plasmatocytes following physically induced fever, there is an increase in these phagocytic cells in the lymph nodes, spleen, and liver. Clinical reports of the comparative effectiveness of these two methods of fever production in central nervous system syphilis indicate that they are of about equal value. When combined with administration of tryparsamide, physically produced fever is stated to give a higher percentage of good results. When properly administered, the danger of causing a fatality is much less than with malaria.



## APPARATUS

## INSULATION METHOD

Present day techniques for the production of fever by physical means have two objects in view prevention of heat loss and introduction of heating

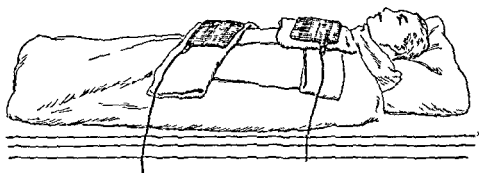

FIG. 105 Fever technique with blankets Flexible electrodes on anterior aspect of body are connected to the short wave machine

energy into the body Prevention of heat loss is of itself sufficient to cause an elevation of systemic temperature If the body is wrapped in several layers of blankets, the systemic temperature will rise gradually, at the end of a period of several hours, it may reach  $103^{\circ}$  or  $104^{\circ}$  F, or higher Since for practical purposes this method is too slow, it becomes necessary to provide additional heating energy for the body

## HOT WATER BATHS

Perhaps the simplest physical measure for elevation of systemic temperature is the hot bath One technique for this purpose consists in the immersion of the patient in water at a temperature of about  $100^{\circ}$  F Hot water is then permitted to run into the tub and is constantly stirred so that the temperature of the water is increased  $1^{\circ}$  F every five minutes After about thirty five minutes, when the temperature of the water has reached  $107^{\circ}$  F, the rectal temperature of the patient will be about  $105^{\circ}$  or  $106^{\circ}$  F This rise in systemic temperature is too rapid and tetany frequently results When the patient's temperature has reached the elevation desired, he is removed from the tub, placed in bed, and carefully surrounded with blankets To insure a minimum heat loss the patient should be wrapped with a sheet, then with a layer of blankets, then a rubberized sheet, and finally another blanket The head is left exposed, and the sheet should be turned down around the neck to prevent contact with the rough blanket Each leg should

be wrapped separately to permit easy access to the perineum for the purpose of frequent determination of rectal temperature, and to allow, if necessary, for urination and defecation. Since some heat loss occurs in spite of these

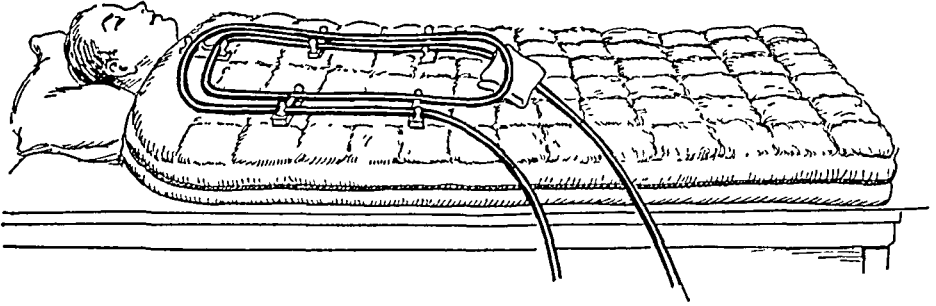

FIG. 106. Fever technique. Patient in sleeping bag with cable in position.

wrappings, it is necessary to provide additional heating energy by means of hot water bags placed on the feet and other parts of the body, or by means of hot tea or lemonade. In this way it is possible to maintain the rise in systemic temperature for as long a period as desired, and even to elevate it still further. To guard against this latter possibility, the rectal temperature should be recorded frequently. With the unwrapping of the covers at the end of the treatment, the systemic temperature returns to its original level (Fig. 105).

#### SLEEPING BAGS

Because the mummifying procedure described in the preceding paragraph may be uncomfortable for the patient, special insulated sleeping bags have been constructed. The bags are large enough to allow the patient to move his extremities and even to turn around. The upper portion of the bag is held away from the patient by a tentlike arrangement with a rope passed through rings that are sewed to the upper surface and tied to a support. Openings, which can be closed with zippers or strings, permit ready access to the patient. After the patient is placed within the sleeping bag, heat may be applied to the body by the short wave current, utilizing condenser plates or the induction coil. With the former one condenser electrode may be placed under the area of the upper back and the other under the buttocks, outside of the bag. The induction cable is arranged as a coil or in the shape of a "U" (Fig. 106). Or two such coils may be applied, one on the anterior and the other on the posterior aspect of the patient. When the desired temperature level has been reached, the heating apparatus should be removed, and it should be reapplied only if the systemic temperature falls below the desired level.

## HORIZONTAL CABINETS

A horizontal cabinet may be used instead of the sleeping bag. It permits much greater freedom of motion for the patient and is the apparatus most commonly employed for fever therapy in this country. At first, I used a

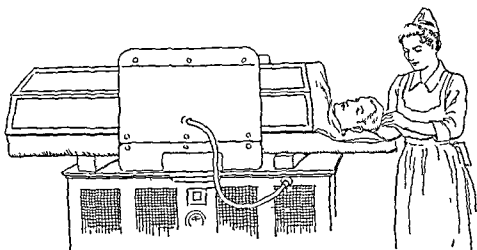

FIG 107 Apparatus for fever therapy with large condenser plates on either side of patient who is lying under the hood on the canvas stretcher

cabinet placed above an oscillator, and large condensers held on either side (Fig 107). Several types of these horizontal heating cabinets are now available. In one, electric light bulbs in the upper portion of the cabinet provide the heating source. Another cabinet employs infra red heating units, which may be placed in a compartment beneath the platform on which the patient lies or in a division of the cabinet. The air in the cabinets can be circulated by a fan. There are several methods for regulating the humidity. The percentage of moisture within the cabinet can be raised by means of water placed in a shallow pan in a compartment under the patient. The circulating air picks up moisture from this source so that the cabinet humidity is held above 80 per cent. A device permitting toweling or cloth to dip into the pan of water greatly increases the surface from which water may be absorbed. The humidity of the air within the cabinet may also be raised by simply suspending moist cloths or towels within it. Another method provides an endless belt of felt extending for nearly the entire length of the cabinet which passes over rollers and dips into a shallow pan containing water. The belt may be rotated by a handle placed outside the cabinet, the speed of rotation determines the amount of water taken up by the air and so controls the humidity within the cabinet. In another cabinet a fine spray of water

is used. This is a good method, but it requires special plumbing facilities.

The cabinet illustrated in Figure 108 was constructed in the hospital where it is used. In it the air is heated and humidified. Additional convective heat-

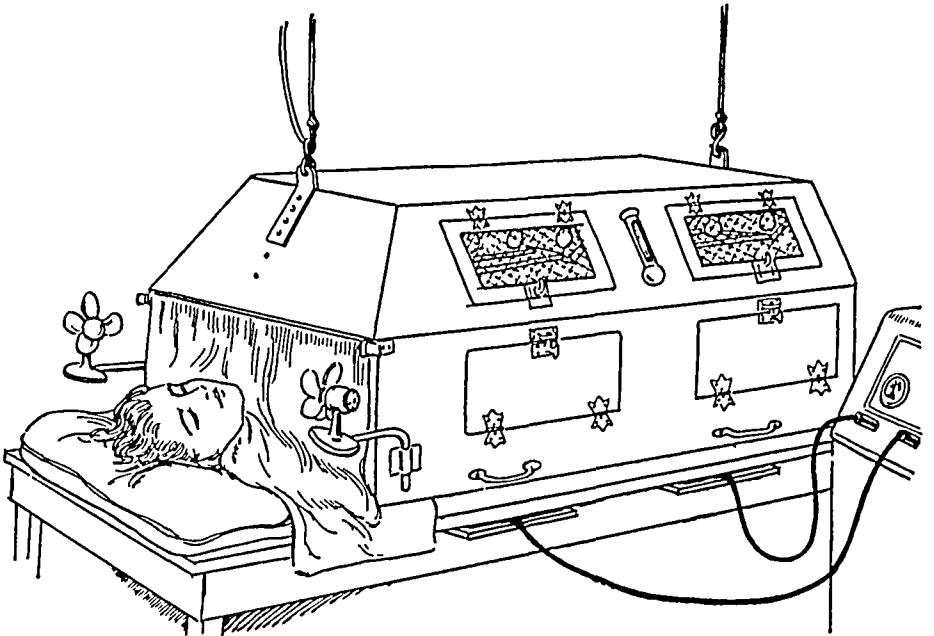

FIG. 108. Fever technique. Photothermal cabinet with electrodes under table.

ing is applied, particularly for the initial stages of temperature elevation. The apparatus consists essentially of a horizontal boxlike enclosure built to fit snugly over a mattress. The mattress, 78 by 36 inches, is placed on a wooden table. The cabinet is suspended from an overhead support and counterbalanced to permit it to be raised easily and quickly. The cabinet framework is made of strips of pine,  $1\frac{1}{2}$  by  $2\frac{1}{2}$  inches, covered with an outer sheeting of  $\frac{1}{8}$  inch flexboard which is secured to the frame with counter-sunk brass screws. On the inside the spaces between the framework ribs are filled with  $\frac{1}{2}$  inch-thick insulating board secured with finishing nails. Twelve 60 watt carbon filament lamps are placed in the upper portion of the hood, and connected by asbestos-covered wire (14 gauge) run in a wire mold conduit. The lamp banks are arranged so that either two, eight, or twelve lamps can be switched on as desired. To prevent the patient's body coming in contact with the hot lamps, a wooden guard is placed between them and the patient. For humidification, a long narrow endless belt of felt run over rollers dips into the water of a shallow pan. An apron hung over the front end of the cabinet retains the heat within it. This is made of washable cloth which is readily removable. It loosely encircles the patient's

neck. Four doors on each side of the cabinet permit ready access to any part of the patient's body. The upper two doors on each side are provided with wired, wide, clear glass panels, to permit continuous inspection of the patient's body while he lies within the closed cabinet.

When the cabinet is in use a rubber sheet is placed over the mattress. A woolen blanket is spread on top of this and covered with a regular hospital sheet. The pillow used for the patient's head is also of regular hospital size. It is covered first with a rubber pillow case and over this, with the usual white pillow case. At the end of each treatment the rubber sheets are washed with lysol solution and the cloth sheets are washed.

If it is desired to supplement the heating units contained within the cabinet, the converse heating of the short wave current may be applied. For this purpose, two electrode pads 12 by 18 inches are placed on wooden slides on the under surface of the supporting table, in positions corresponding to the area of the upper back and the region of the buttocks.

## PHYSIOLOGY

### SKIN SURFACE TEMPERATURE

A knowledge of the physiological changes produced by fever therapy is essential in the evaluation of techniques and of therapeutic possibilities. When the body is supplied with heat producing physical energy in a quantity sufficient to overcome its thermoregulatory mechanism, it makes an added effort to increase its dissipation of heat. Sweating results. The skin surface temperature rises promptly. The usual skin surface temperature gradient (the temperature of the skin covering the fingers, the lower extremities and toes is normally several degrees lower than that of the torso) is abolished, and all portions of the body skin surface reach a more or less common temperature level. This level is lower than that occurring in the interior of the body, even when the temperature of the surrounding air is much higher. In fever produced by intravenous injection of typhoid vaccine, the temperature of the skin surface of the extremities does not rise until after the systemic temperature has become markedly elevated. Thereafter it rises and the gradient disappears. Bazett noted that "while on exposure to the heat there is therefore evidence of diminished peripheral resistance in the skin area, in fever, particularly during the stage when the temperature is rising, the skin appears pale, the veins are constricted and vasoconstriction in this area is indicated by a temporary failure to increase heat loss in spite of the rise in body temperature."

## CARDIOVASCULAR SYSTEM

The velocity of the blood flow becomes markedly accelerated during fever therapy. We have observed an increase of more than 400 per cent. This acceleration may be accounted for by the changes in the pulse rate and the blood pressure. The pulse rate increases. In 500 observations we found that the rate of increase averaged 8.5 beats per minute for each degree of Fahrenheit of temperature elevation. In experimental pyrexia, Bazett noted that the pulse rate varied with the body temperature (as it does in natural fever), increasing from eight to ten beats per minute for each degree above 98.8° F. A sudden rise in the pulse rate during the administration of fever may be a danger signal, particularly if the pulse is weak, thready, and irregular. A rate of over 160 per minute usually calls for cessation of treatment or lowering of the temperature level.

Employing the usual auscultatory technique, we noted that the systolic blood pressure usually shows a slight elevation followed by a gradual fall to a point below the original level. The sound associated with the diastolic pressure becomes audible at increasingly lower levels until it is heard (though frequently changed in character) when the mercury in the manometer reaches the zero level. After a period of an hour or two the diastolic sound is heard at higher levels, until it reaches a point slightly above the original one. A fall of the systolic pressure to below 80 mm. Hg may be a sign that the patient is suffering from shock or vascular collapse. The pulse pressure becomes markedly diminished; if it is less than twenty, the treatment should be stopped. The reduction in blood pressure may result from severe dehydration. The consequent insufficient blood supply to the brain may cause collapse. The increased permeability of the blood vessels favors edema formation.

Although these patients lose large quantities of fluid through sweat (as much as 3 to 4 liters), their weight at the end of the treatment may be the same as that at the beginning if they are permitted to drink as much fluid as they desire. Gibson and his co-workers have called attention to the danger of a diminishing blood volume during administration of physically induced fever. The water loss is particularly great during the induction stage. Therefore, when the induction time is longer than two hours, there is greater risk of reduction of the plasma volume. With diminished blood volume, anoxemia of the tissues may occur, inasmuch as tissue metabolism becomes increased from 50 to 60 per cent. Capillary damage results, with extravasation, thus causing further reduction in blood volume. If water passes out of

the blood stream more rapidly than it can be absorbed from the intestinal tract, intravenous administration of fluid will be necessary. Gibson found that the average rate of fluid intake necessary to maintain the plasma volume level was about 8 cc per hour per kilogram when diathermy was the heat source, 9 cc per hour per kilogram with a cabinet employing heated air, and 6 cc for the same time and weight when radiant energy was employed. High relative humidity in the cabinet diminished the gross water loss from the body. In patients responding poorly to the treatment a loss of tissue fluid exceeding 5 cc per hour per kilogram of body weight was encountered.

The number of white blood cells is altered during fever producing procedures. There is initial leucopenia of about 25 to 30 per cent during the first and second hours following the inauguration of hyperpyrexia. This is followed by leucocytosis reaching a maximum (about 80 per cent above the initial figure) between the sixth and ninth hour. The greatest variation is in the total number of the neutrophils, the staff neutrophils show the largest increase. Appearance of immature forms (myelocytes, metamyelocytes, premyelocytes, and myeloblasts) together with the neutrophilia indicate stimulation of the bone marrow. There is diminution in the number of lymphocytes. The red blood cell count remains about the same unless dehydration occurs.

#### RESPIRATIONS

The respiratory rate increases during fever therapy. At high temperatures, periods of apnea may develop, gradually increasing in frequency and duration until respiratory effort may not be visible for as long as one minute. Between these apneic periods are intervals of increased rate and depth of respiration. When the systemic temperature is reduced, the apneic periods become less frequent and shorter, and gradually normal respiratory excursions are re established.

These changes in the character of the respiratory movements are reflected in the altered status of the oxygen and the carbon dioxide contents of the blood and in the consequently increased pH. Loss of chlorides in the sweat and of CO<sub>2</sub> through overventilation may cause alkalosis. This tendency is accelerated by the increased production of weak organic acids, which help to fix more alkali, and by the relative anuria which prevents renal excretion of excess alkali. Very infrequently jaundice may be observed after a prolonged treatment. Increase in the icteric index occurs with a lowering of serum chloride. The chloride lack should be counteracted by administration of saline, preferably given intravenously. Extreme loss of chlorides, resulting

from heavy sweating, diminishes the chlorides in the blood, but the migration of the chlorides from cells to serum results in a changed distribution ratio. Loss of chlorides is also reflected in a reduced chloride content of the urine. The gastric juice shows a similar loss of chlorides with a virtual cessation of free hydrochloric acid secretion.

#### PATHOLOGY

Death may follow too high an elevation of temperature. Fortunately this is a rare occurrence when proper precautions are taken. In my own experience, embracing several thousand treatments, there has been but one death. The patient, among the first to be treated, was a badly demented parietic. The pathological changes leading to death have been described by Hartman. On gross examination, he found engorgement and congestion of blood vessels, degeneration and hemorrhage in the adrenals, hemorrhages in the brain, marked edema and congestion of the lungs, contraction and bloodlessness of the intestine, and parenchymatous degeneration of the liver and kidneys. Microscopically, there was acute passive congestion of all organs and tissues, and cellular degeneration and hemorrhages of varying degree in the adrenals, liver, brain, lungs, and kidneys. Hartman ascribes these changes to anoxia produced by alkalosis, accelerated blood flow, increased temperature of the blood, and increased demand for oxygen in the tissues. This last results from increased metabolism and depressed utilization of oxygen by the tissues, especially the brain, attributable to the histotoxic effect of the sedatives used. As preventive measures he recommends copious ingestion of fluids, cooling of the head by means of an electric fan and ice, and inhalation of oxygen and carbon dioxide for alkalosis and apnea.

Wilson, describing the pathological findings found at autopsy in four fatal cases of heat stroke (three of them resulting from fever therapy), states: "The most striking and probably the actual fatal mechanism is rather extensive hemorrhage under the endocardium of the left ventricle, especially on the septal wall in the region of the bundle of His."

#### TECHNIQUE

Of great importance is the technician-nurse's attitude toward the patient. When the patient comes for treatment for the first time he may be very nervous because of what he has read or heard concerning the severity of the treatment, and he must be reassured. If the technician can gain his confidence and make him feel that he can rely on her judgment, the treatment will be less strenuous. She should evidence her desire to be sympathetic and



helpful. This she can do by wiping the perspiration from his face and by giving him water immediately after he expresses a desire for it, by talking to him if he wishes to engage in conversation, and, more important, by a sense of certainty in her activities indicating a self-confidence gained by long experience. A good technician, even though she works with relatively poor apparatus, is far better than a poor technician working with the best type of apparatus. The fever therapy technician should be a well trained nurse. It requires a nurse's training to be able to tell the difference between a good pulse and a thready one, between respiratory variations which are within the normal range and those which indicate grave danger. She should be able to read the numerous signs and symptoms which indicate whether a patient is doing well or poorly. In addition to keen observation and appreciation of a patient's symptoms, she should have an even disposition and a great abundance of patience. She should also be able to think and act quickly when emergencies arise, without indicating any sense of alarm to the patient. Every three months or so it is a good plan for the nurse to review those measures which are required if an emergency should arise in the course of treatment.

#### PREPARATION OF THE PATIENT

Meals rich in calories, vitamins, and salt should be prescribed during the day preceding treatment. The treatment is usually started early in the morning. An enema should be given the preceding night, or, if this is not possible, shortly before the patient is brought to the fever room. Breakfast should be limited to tea and toast or crackers and milk, except when the temperature elevation will be relatively low and the duration of the treatment comparatively short. When the patient is transferred to the cabinet bed, all clothing and jewelry should be removed. The body is covered with a sheet or bath towel to help absorb perspiration. The feet and legs are encased in quilted muslin boots containing several layers of flannel, and extending well over the knee. In order to allay any apprehension, the patient should be reassured by a description of the sensations which he will experience. He should understand that the personnel are anxious to make him as comfortable as possible. Mouth and rectal temperatures, pulse and respiration are recorded.

To save time, the cabinet may be preheated, but much of this heat is lost when the cabinet is raised to introduce the patient. After the patient is in the cabinet, the hood drawn down and all the lights turned on, the short wave current is turned on with the electrodes placed as described previously (page 179). The first stage of fever treatment is that of temperature elevation, the

second stage that of temperature maintenance; and the third, that of temperature reduction.

#### STAGE OF TEMPERATURE ELEVATION

Before beginning a treatment the technician-nurse should be definitely told the height and the duration of the temperature desired. With techniques such as those that we have described the convective heating energy should be discontinued when the patient's temperature reaches a level a degree or a degree and one-half below that desired; the temperature will then usually coast up to the predetermined level. When this has been reached, comparatively little thermal energy is required to maintain it; the conductive heating within the cabinet and the insulating effect of a somewhat higher temperature than that within the body itself may be adequate. For the continuous observation of rectal temperature, one of the indicating thermometers gives the most satisfactory results. Because these instruments may get out of order, it is advisable to check them every hour or so against a clinical thermometer inserted into the rectum beside the indicating thermometer.

Much more thermal energy is needed to raise the body temperature during the first stage than to maintain it during the second. Maximum heating is applied until the patient's temperature reaches 101° F. During the first fifteen minutes or so, there may be no change in temperature, because the body is successfully counteracting the influence of the thermal energies. During this period, the skin becomes red due to increase in its circulation, and perspiration occurs. When the compensatory mechanism for heat loss becomes inadequate, the temperature of the entire body begins to rise. The pulse and respiratory rates also increase, and the patient begins to feel uncomfortable.

*Sedation.* The discomfort may be minimized by sedation. After testing many sedatives, including sodium amytal, seconal, paraldehyde, luminal, chloral hydrate, morphine sulphate, and hyoscine hydrobromide, we have come to rely mainly on morphine and seconal. When the elevation of temperature is maintained at a high level and for a prolonged period of time, a combination of morphine and seconal gives the most satisfactory results. We usually administer morphine sulphate, grain  $\frac{1}{6}$  for the average-sized adult. In the presence of an elevated temperature the effect of drugs is increased. It should be borne in mind that morphine and the barbiturates may so disturb the control of the heat centers that a further rise in body temperature follows their administration. A rise of one or two degrees following rapidly the use of sedation when the systemic level is only 101° or

102° F may not be important, but it obviously becomes a matter of vital importance if this sudden elevation occurs when the patient's temperature has reached 106° or 106.5° F. Failure to recognize this reaction to these drugs may account for some of the deaths which have occurred during administration of fever therapy. If it is necessary to repeat the sedatives when the temperature is at a high level, the temperature should first be lowered a degree or so. If the treatment extends longer than four or five hours, it is frequently necessary to repeat sedation. A small dose of morphine sulphate (grain 1/6) is usually adequate. Seconal is also helpful. Since sedatives exert a depressing influence on the central nervous system, they should be employed as sparingly as possible. Hartman warns against the barbiturates, especially sodium amytal, and suggests the use of sedormid.

#### STAGE OF TEMPERATURE MAINTENANCE

When the rectal temperature rises above 101° F, the cabinet temperatures should be reduced by turning off some of the lamps. As his temperature continues to rise, the patient may complain of headache, nausea, shortness of breath, palpitations, thirst, or a sensation of numbness of the hands and feet. A small electric fan blowing continuously on the face or a cold compress placed on the head makes him feel more comfortable.

*Use of Fluids* Fluids should be administered freely. According to the patient's preference, any one of the following may be given: plain water and cracked ice, plain water containing sodium chloride (0.6 per cent), carbonated water to which sodium chloride has been added, lemonade, orangeade, grapefruit juice with or without sugar, ginger ale, grape juice. If the patient is nauseated or vomits, he may prefer simple cracked ice. Records should be kept of the amount of fluids ingested. 3 to 6 liters may be taken during a six to ten hour treatment. The patient should be given as much water as he asks for. However, if he imbibes large quantities of cold water and drinks it rapidly, he may vomit much of it. Apparently the absorption of water from the gastro-intestinal tract is not sufficiently rapid, and the stomach becomes distended. If there is evidence of dehydration (this may be shown by thready pulse, low blood pressure, restlessness, air hunger), the blood volume can be speedily increased by intravenous injection of salt solution. To prevent fluid loss from the body as much as possible, Gibson and his co-workers suggested that the humidity within the cabinet be held at a very high level, possibly 90 per cent or higher. These authors emphasize the importance of maintaining a high humidity within the cabinet, inasmuch as readings below 50 per cent cause a reduction in plasma volume with severe dehydration.

This process is accelerated if the air within the cabinet is circulated rapidly. They also advise that comparatively low air temperatures be used with the high humidity, because the severity of the dehydration may be sufficient to bring about a critical degree of alkalosis.

*Use of Salt.* To compensate for the large quantities of sodium chloride lost in the sweat, an effort should be made to increase the sodium chloride intake. The patient may be instructed to sprinkle his food liberally with salt on the day before treatment. Or he may be given sodium chloride in capsules, about 15 grains every four hours, on the day before treatment. During treatment salt solutions are administered. Cold water containing salt in the proportion of 0.6 per cent is usually employed. Some physicians prefer salt solution of smaller content. We have found that salt solution frequently produces nausea and vomiting, and occasionally, diarrhea, and therefore we do not insist that the patient take it if he objects vigorously. When intravenous administration seems desirable, we give 1000 cc. of physiologic salt solution containing 5 per cent sugar.

*Temperature Determination.* A careful watch of the systemic temperature is of the utmost importance during administration of fever therapy. The rectal temperature is a much more accurate index than the oral. The recording on a clinical thermometer may be relied on if the instrument is accurate and properly inserted into the rectum and held there for a sufficiently long time. A mouth temperature reading may not be accurate if the thermometer is not placed sufficiently deep into the mouth and held firmly beneath the tongue, or if the mouth is kept open, or if the patient has drunk cold water shortly before. If cold water has been swallowed, at least five minutes should elapse before the mouth temperature is taken. In simultaneous recordings of mouth and rectal temperature, we found that the temperature of the mouth may vary greatly from that of the rectum. Usually it is  $0.7^{\circ}$  F. lower than the rectal temperature; it has been as much as two degrees lower. Occasionally it is as high as the rectal temperature, and vary rarely, even higher. When the systemic temperature is high, it is desirable to observe the rectal temperature continuously. This can be done by using a continuous indicating thermometer inserted in the rectum, of which several are available. They are comparatively expensive. A long rectal thermometer protected by a frame makes a satisfactory substitute. With this, the temperature may be read through a window in the cabinet while the thermometer remains within the rectum. Usually, however, the temperature is observed by repeated insertion of a clinical thermometer. The frequency of insertions will depend on the temperature of the patient: at higher levels, that is, around

106° F, this should be every ten minutes, below 105° F every fifteen minutes is adequate

*Claustrophobia* Occasionally a patient who suffers from claustrophobia becomes restless when placed in the fever cabinet. If the claustrophobia is severe he will not tolerate the cabinet at all. It then becomes necessary to use another fever producing technique, such as that in which the patient is wrapped in blankets and the heating energy applied conversively by short wave current. Fortunately severe claustrophobia is rare, although milder cases are not infrequent. As a rule this situation can be controlled by permitting the patient to take his arms out of the cabinet. The feeling that he can move his arms in any desired direction appears to be adequate to counteract his fears. It is more difficult to raise and to maintain the systemic temperature if the arms are left bare, but if they are covered with toweling or some other form of thermal insulation, the heat loss can be held to a practical minimum. When the systemic temperature reaches a high level the patient may become disoriented, but treatment need not be discontinued unless he becomes violent.

*Care of Cyanosis and Circumoral Pallor* At high temperatures it is not uncommon for the patient to develop some degree of cyanosis. Frequently the rate and depth of respiration is irregular. During the relatively apneic period, cyanosis may make its appearance and gradually increase in intensity until the patient begins to breathe again rapidly and deeply, the cyanosis then disappears. If the patient will respond to a request to take several deep breaths, the cyanosis will disappear. Experience enables the observer to distinguish between the degree of cyanosis which is relatively common in patients whose temperature has been maintained for a long period at a high level, and the degree which should give cause for alarm. In the former instance, the cyanosis is relatively slight and there are no other indications of failure of the respiratory or cardiovascular system. A few inhalations of 5 per cent carbon dioxide and 95 per cent oxygen may restore the patient to normal color. In the more serious type of cyanosis, it may be necessary to terminate the treatment abruptly, to reduce the temperature of the body as quickly as possible, and to give carbon dioxide and oxygen inhalations, and salt solution intravenously. The continuous administration of oxygen is a valuable procedure because the arterial oxygen tension becomes reduced. The nasal catheter technique is the simplest for this purpose.

Circumoral pallor may occur during fever treatment. Some authorities consider this a dangerous sign. We have frequently observed it when high temperatures were maintained for a long period. However, as the patients com

pleted their treatment in an uneventful manner, we do not consider it a danger signal unless it is intense. Herpes simplex frequently develops directly after a treatment. At times, it may be very severe, involving the inside of the nose and mouth as well as the skin of the lower portion of the face. Since the lesion disappears spontaneously within a few days, treatment need not be discontinued.

#### STAGE OF TEMPERATURE DECLINE

When the treatment has been completed the temperature is lowered by removing the cabinet and coverings. A light dry sheet is placed over the patient. In the usual surroundings, the temperature at first falls rapidly, and then more gradually. The return to normal from a level of about 106° F. is largely effected in the course of an hour or so. The decline may be hastened by sponging with cool water or alcohol. As soon as the treatment is discontinued, the patient feels more comfortable because his temperature is falling. It is the fall or rise in temperature that determines the patient's comfort, and not the temperature level itself. The patient usually feels more uncomfortable when the temperature is being elevated from about 101° to 104° F. than after it has reached 105° or 106° F. During this earlier transition stage he should be assured that he will soon feel more comfortable.

When it becomes necessary to reduce the temperature of the patient quickly, all heating measures should be discontinued. The patient should be taken from the cabinet or the cabinet should be removed from the patient, as the case may be. An electric fan should be played over the patient's body. Sprinkling tepid water over the patient or covering him with a sheet wet with water while continuing to play the fan over him will still further hasten the lowering of the systemic temperature (Fig. 109). It is not advisable to use very cold water or to immerse the patient in a tub containing ice water, because these measures cause peripheral vasoconstriction, and thus interfere with heat loss. The evaporation of alcohol helps to cool the body quickly. The friction with which it is applied produces a mild erythema, while the alcohol itself is quickly evaporated by electric fans.

There are several indications for termination of treatment. If the pulse rate becomes very rapid, exceeding 160 per minute, or irregular or weak, treatment should either be stopped or the temperature lowered. During treatment, the systolic blood pressure may first rise slightly and then return to its original level; a fall below 80 mm. Hg calls for cessation of the treatment. In some cases respiration becomes rapid and at times irregular. There

may be alternating periods of rapid breathing and cessation of breathing. These respiratory changes may be more pronounced after administration of morphine.

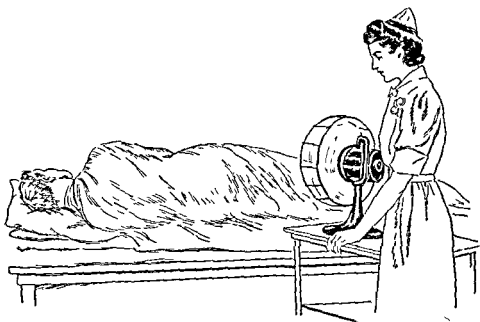

FIG 109 Technique for reduction of systemic temperature. Fan blowing on patient who is covered with a wet sheet.

#### SPECIAL REACTIONS TO FEVER THERAPY

The reactions to fever therapy vary with different patients. Some more or less characteristic variations occur in different diseases. A patient with syphilis of the central nervous system, for example, may be much more restless during treatment than patients suffering from certain other diseases. In the presence of severe psychoses, as in general paresis, strong sedation or a restraining sheet may be required. Mental disturbances may develop in other persons, particularly if the duration of the fever is prolonged. In such cases treatment should be discontinued as the patients are no longer subject to reason and may, in fact, be quite unconscious of their own acts. Ebaugh and his co-workers state that the anxious, unstable individual who is self-concerned and apprehensive is unsuitable for fever therapy. They attribute the relatively infrequent appearance of delirium in their patients to increased experience and limitation of sedatives. They administer one dose of pentobarbital (grains  $1\frac{1}{2}$ ) or morphine (grain  $\frac{1}{6}$ ). They find that codeine (grains  $1\frac{1}{2}$ ) is preferable in children.

Patients suffering from chorea may require special care. Because of their uncontrolled movements they may injure themselves by striking some part of the cabinet. Inasmuch as these patients are usually children from six to

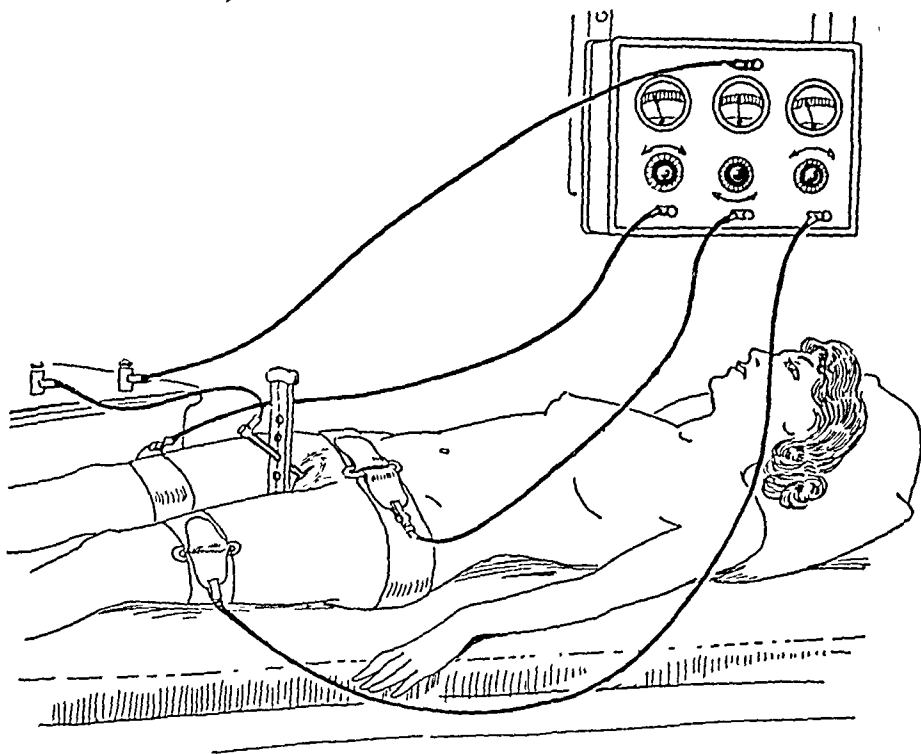

FIG. 110. A technique for application of long wave diathermy to the pelvis. One terminal of the diathermy machine is connected directly to the vaginal electrode held firm within its holder. The other terminal of the machine is connected to a distributor from which three electric cords conduct the current to the three dispersive electrodes. These are wide metal bands surrounding the pelvis and both thighs. The distributor contains 3 milliamperemeters to indicate the current flow on each of its subdivisions and also three rheostats to permit changes in resistance in the three subdivisions of the circuit.

fourteen years of age, there is adequate room in the cabinet for pillows or other protective agents. As a preliminary to the treatment of patients suffering from chorea, we have administered from 2 to 4 grams of paraldehyde, rectally, one-half hour before the treatment. The sedative effect lasts until the patient begins to perspire actively; thereafter it wears off quickly and small doses of morphine should be given.

Patients with subacute bacterial endocarditis present special problems. Because many of them are febrile before fever therapy is initiated ( $100^{\circ}$  to  $103^{\circ}$  F.), the amounts of convective and conductive heating employed in other conditions may cause the systemic temperature to climb too rapidly and to too high a level. The patients whom we have treated have received



huge doses of sulfanilamide before and during the treatment. This medication may give the skin a bluish gray color, thus making it difficult to recognize the onset of cyanosis. The pulse rate may be rapid, varying from about 130 to 160 per minute. Nausea, circumoral pallor, and very rapid respiration are symptoms which may develop when the temperature elevation has reached only a comparatively low level, they may be due to the severe cardiac involvement which these patients often present. We have also observed that a skin eruption may develop during the treatment, or on the day following, this may cover the entire body or it may be localized on the chest, hands, and arms. It is not uncommon to see the patient fall asleep during the treatment, after having received a small dose of some sedative, particularly when the elevation of temperature is comparatively slight ( $100^{\circ}$  to  $103.6^{\circ}$  F) and maintained for only two to three hours.

Patients with skin diseases such as neurodermatitis, chronic eczema, and the like, should not be given sedative medication during treatment. As the primary objective of treatment is to increase the circulation within the skin, we rely solely on the conductive and convective heating produced by the electric lights within the cabinet to produce the desired slight elevation of systemic temperature. These patients can be comforted by engaging them in conversation.

When treating gonorrhoea in women, we elevate the systemic temperature to between  $105^{\circ}$  and  $106^{\circ}$  F, and apply additional local heating to the pelvis. The systemic temperature elevation is maintained for about ten hours, during five or six of which local pelvic heating is applied by means of long or short wave diathermy (Fig 110).

#### COMPLICATIONS AND THEIR TREATMENT

Fever producing therapy is uncomfortable but painless. There is an element of real danger if the systemic temperature is permitted to exceed  $107^{\circ}$  F. Continuous watchfulness is imperative. Ewalt and his co-workers reviewed the complications which may arise during fever therapy, and also the methods of controlling them. To allay apprehension it is suggested that the rationale of the treatment and the description of its technique be explained and that the patient be introduced to other persons taking the treatment. The conduct of the nurse technician is very important. A considerate and assuring approach allays disquieting thoughts better than anything else. The psychology of this approach is also of value in the treatment of delirium. Cold applied to the head is of great help. If delirium occurs as a result of cerebral edema, a 50 per cent solution of glucose or sucrose is

administered intravenously. Ewalt suggests the use of pre-fever spinal drainage as a method of preventing cerebral edema in agitated parietic patients. If the doctor or nurse cannot influence the delirium by conversing with the patient, sedatives should be administered. We have not found it necessary to employ restraining measures although these have been used in other institutions. The occurrence of tetany is due to lowered blood serum calcium. The injection of 10 cc. of calcium chloride intravenously or the inhalation of 5 per cent carbon dioxide, 95 per cent oxygen mixture gives relief.

Marked dyspnea can usually be diminished by inhalation of a mixture containing 5 per cent carbon dioxide and 95 per cent oxygen. Krusen has suggested the routine intermittent administration of oxygen during fever therapy by means of a mask held lightly over the patient's nose, or nose and mouth.

Tachycardia may occur. A rate of 160 per minute may require cessation of treatment. It has been recommended that from 50 to 100 cc. of 50 per cent glucose be administered to control tachycardia; if this fails, a venoclysis should be performed. If the heart sounds become indistinct or if evidence of heart block or extrasystoles develop, the possibility of cardiac failure must be recognized, and treatment stopped.

Vomiting occurs frequently. It is usually a sign of gastric distention due to the large intake of fluids. It is therefore ordinarily of no particular significance. Should it persist with resulting evidence of dehydration, it is necessary to replenish the body fluids by intravenous injection of salt solution. Projectile vomiting is a sign of cerebral edema. Abdominal distention may be due to large fluid volume in the stomach and to the presence of gas. The latter may be relieved by the use of a rectal tube if changing the position of the patient proves inadequate.

Burns can be prevented by avoiding high cabinet temperatures and by covering the patient with sheets and towels. The skin should be observed through the windows of the cabinet. If there is evidence of marked local erythema, the patient should be moved away from the heat source. The area may be rubbed with oil or coated with some ointment such as butesin picrate. It has been suggested that in patients whose skins are particularly sensitive, the erythema tolerance can be increased by previous exposure to ultraviolet radiation. When the short wave current is employed the accumulation of moisture on the skin may produce arcing with its consequent danger of burns. The patient's complaints of thermal discomfort in any part of his body should always be heeded.

In our experience jaundice is an extremely rare occurrence. Warren sug-

gests that jaundice can be prevented by maintaining the chloride balance. Sodium chloride may be administered by mouth, by hypodermoclysis, or by vein, until the kidneys are excreting from 3 to 6 grams of sodium chloride every twenty-four hours. It is recommended that the daily dose of sodium chloride be 15 grams a day until the jaundice disappears.

The formation of herpes simplex is a common sequela to fever therapy which need not interfere with subsequent treatments. As a rule, it is not disturbing, but at times it can be severe, involving the nares and interior of the mouth as well as the circumoral skin. To hasten drying of vesicles and to reduce discomfort, we have applied ammoniated mercury, 5 per cent. Other preparations that are recommended are compound tincture of benzoin, 50 per cent alcohol, ointments containing cold cream and spirits of camphor.

Dehydration may produce peripheral vascular collapse. The patient becomes pale, sweating stops, blood pressure falls and the pulse rate increases while its volume diminishes. For the treatment of this condition in its early stages, 2 to 5 grams of salt may be administered by mouth in a 2 to 5 per cent solution, followed by caffeine and strong tea with sugar. Caffeine sodium benzoate may be injected intramuscularly, and 50 to 100 cc of 50 per cent glucose may be given intravenously. If this is inadequate to control the situation, fluid is administered by venoclysis. Ringer's solution is said to be preferable. It is administered at the rate of 1500 to 2000 cc an hour. Fifty cubic centimeters of 50 per cent glucose solution and 50 cc of 4 per cent sodium chloride solution may be injected through the venoclysis tube for each 1000 cc of Ringer's solution.

The intake of sufficient fluid and salt prevents the possible occurrence of heat stroke. The symptoms of this condition are muscle stiffness and contractions, rapidly increasing temperature, and coma. Measures should be adopted immediately to lower the temperature. Krusen calls attention to the fact that in heat stroke the blood pressure is elevated. It may be necessary to withdraw from 400 to 500 cc of blood, particularly if there is evidence of pulmonary edema. In heat exhaustion, on the other hand, the blood pressure is lower, and solutions of salt should be injected into the vein. Sometimes injections of caffeine and glucose, or inhalation of oxygen and carbon dioxide mixtures are used. Cerebral edema is manifested by projectile vomiting. Delirium and restlessness is followed by coma and convulsions. Ewalt recommends intravenous injection of 100 cc of 50 per cent glucose or sucrose solution to abort the attack. If necessary hypertonic glucose and salt are also given. Spinal drainage is employed if convulsions occur. An effort should be made to reduce the temperature immediately by means of evaporation.

of alcohol or water. It is occasionally necessary to induce light narcosis by the intravenous injection of nembutal or sodium amytal.

Pruce found that shock following physically induced fever therapy was successfully treated by the intravenous injection of 250 cc. of blood plasma after the usual accepted antishock measures, including intravenous solution of sodium chloride and hypertonic dextrose and oxygen, had failed.

#### INDICATIONS

The results obtained by fever therapy in the treatment of all forms of gonorrhoea in both sexes are excellent. In almost all cases it is possible to cause the complete disappearance of the organism with a single treatment (usually at about 106.5° F.) of ten or more hours' duration. The combined use of fever and the sulfonamides increases the effectiveness of each. The sulfonamides alone will often cause the disappearance of gonococci. Therefore these drugs should be a preferred treatment in gonorrhoea, as their use is much simpler, less strenuous, and less expensive than fever therapy. However, when the sulfonamides fail, recourse must be had to fever therapy. In such cases excellent results are obtained by giving one of the sulfonamides (sulfapyridine or sulfathiazole) during the eighteen hours before beginning the fever treatment. The systemic temperature is elevated to 106° F. and maintained at that level for ten hours. Gonorrhoeal endocarditis and gonorrhoeal ophthalmia have been treated successfully, as well as the other complications caused by the gonococcus. The number of chemotherapeutic failures has been reduced with the introduction of penicillin. For these failures fever therapy should be used.

As malaria therapy had proved beneficial in the treatment of general paresis, this disease was one of the first to be treated with physically induced fever. The relative value of the two methods is still a matter of discussion. Each has proved to have great merit. Many authorities maintain that the best results are obtained with a combination of tryparsamide and fever. Ebaugh, Barnacle, and Ewalt state that in a series of 87 cases, the combined use of physically induced fever and tryparsamide was beneficial in 71 per cent, and that the spinal fluid curve was improved or reversed in 52 per cent. With malaria therapy, 58 per cent of the cases were improved; the spinal fluid curve was improved or reversed in 39.5 per cent. Osborne and Markson believe that the chances of re-establishing perfect mental adjustment are excellent in cases of the grandiose and expansive types of dementia paralytica in which the onset has been sudden. They consider that parietic patients who show increasing dementia and depression are a more serious risk, and

those already demented should not be treated at all. For the treatment of syphilitic infections of the central nervous system body temperature is raised to 106° F for three to five hours, two or three times a week for ten to twenty times.

Fever therapy has caused the disappearance or diminished the intensity of the pains occurring in many patients with *tabes dorsalis*. In many others, however, it has not caused improvement. This form of treatment has also been employed for the care of other forms of syphilis, such as meningovascular syphilis and syphilis of the eye, that is, interstitial keratitis and optic neuritis. The combination of chemotherapy and fever therapy may succeed in eradicating the *Spirochaeta pallida* from its human host in a single day. Simpson and his co-workers employ for this purpose a ten hour period of fever at 106° F, preceded by a single intramuscular injection of 4 grains of insoluble bismuth. During the first seven hours of the height of fever, 240 mg of mapharsen are administered intravenously by the slow intravenous drip method. These authors state that while no conclusion is permissible since the period of post therapy observation is as yet less than two years, the prompt resolution of clinical symptoms and the favorable serological responses would indicate that further diligent inquiry is demanded.

Although the period of follow up is too brief to permit of conclusive evaluation, several workers report on the effectiveness of combining penicillin with fever therapy in the treatment of syphilis of the central nervous system. Epstein administered 40,000 units of sodium penicillin intramuscularly every three hours for fourteen days, giving a total of 4,500,000 to 5,000,000 units. Physically induced fever was given every three or four days during the course of penicillin therapy. The systemic temperature was elevated to 104 to 105° F and maintained for five hours. He observed that patients who had symptoms of meningovascular syphilis such as transient paralyses, severe headaches, or eye symptoms such as diplopia, improved remarkably. Those with acute mental disturbances of dementia paralytica, such as disorientation, confusion, and excitement, also did well. The tabetic did no better than when fever only was used. The spinal fluid changes were impressive. O'Leary, employing fever produced by malaria concluded that the addition of penicillin improved the results obtained by fever therapy alone, by about 5 to 10 per cent. He likewise noted tonic effects, such as gain in weight and improvement in somatic complaints, following penicillin therapy. Rose and Solomon injected 3,000,000 units of penicillin in each of their patients in combination with an abbreviated course of fever. The need for retreatment in a little more than

one third of their cases followed for one year or more, indicated that this combination is not the optimum treatment for late symptomatic neurosyphilis.

Chorea minor (Sydenham's chorea) is an indication for fever therapy. The percentage of treated cases in which the choreiform movements rapidly subside and disappear is high. Treatments can be given twice a week at a temperature of about  $104^{\circ}$  to  $105^{\circ}$  F., sustained for five to seven hours. It may be necessary to administer six to twelve periods of fever before the desired result is achieved. The presence of rheumatic carditis does not contraindicate the use of fever. On the contrary, carditis appears to be improved by the treatment. Rheumatic fever responds well to elevations of body temperature physically induced. Simmons and Dunn treated 31 cases of rheumatic fever at temperatures varying from  $103^{\circ}$  to  $106^{\circ}$  F. They report complete and prompt relief of joint pains and swelling in almost all the cases. Krusen and his co-workers have treated brucellosis successfully with fever therapy.

Some patients with infectious (atrophic and rheumatoid) arthritis are markedly benefited by the elevation of systemic temperature, but most of them do not obtain substantial relief. Their joints may move more freely and their pains diminish but the gain is frequently only temporary. The technique which we most commonly employ is to elevate the systemic temperature to about  $102^{\circ}$  or  $103^{\circ}$  F. and maintain it there for about two to three hours, twice a week. Patients receiving this type of application are not hospitalized. Results obtained with higher temperatures and longer durations did not seem to be more satisfactory. Arthritis due to brucellosis is benefited by fever therapy, as are other manifestations of brucellosis. Brucellosis spondylitis can be dramatically improved by a few periods of fever therapy.

Some of the chronic skin diseases are as a rule only temporarily improved by mild fever. Temperatures are elevated from  $101^{\circ}$  to  $102^{\circ}$  F. for one or two hours, every day or twice a week. The patients we treated suffered from generalized lesions such as chronic eczema and neurodermatitis. In some cases of asthma, fever therapy appeared to give relief for varying periods of time. Similarly with multiple sclerosis. In both these diseases, occurrence of spontaneous remissions makes it difficult to evaluate the effect of physically elevated systemic temperatures. Certainly when other therapeutic possibilities have proved to be of no avail, fever therapy is worthy of a trial. Shoulders reports that when fever was combined with x-ray therapy in the treatment of malignancy, the results were definitely superior to those obtained by irradiation alone. The patient's temperature was raised to  $104-$

106° F for one hour He was then wrapped in blankets and irradiated One to four such combined treatments were given followed by further applications of x ray therapy

Other diseases which have been treated by means of physically induced fever, with varying degrees of success, include subacute bacterial endocarditis (combined with sulfonamides), lymphogranuloma inguinale, meningococcus meningitis, and neuritis Favorable results have also been reported in the treatment of some eye diseases such as interstitial keratitis, exudative uveitis, choroiditis, and corneal ulcer

## REFERENCES

- BAZETT, H Circulation in pyrexia *J.A.M.A.*, 97 1271, 1931
- BIERMAN, W, and FISHBERG, E Some physiologic changes during hyperpyrexia induced by physical means *J.A.M.A.* 103 1354, 1934
- CARPENTER, C M, and BOAK, R A Thermal death time of the gonococcus at fever temperatures In Simpson and Bierman *Fever Therapy* New York, Hoeber, 1937
- DOAN, C A Differential reaction of bone marrow, connective tissue, and lymph nodes to hyperpyrexia In Simpson and Bierman *Fever Therapy* New York Hoeber, 1937
- EBALGH, F G, BARNACLE, C H, and EWALT, J R Psychiatric aspects of artificial fever therapy *Arch Neurol & Psychiat*, 39 1203, 1938
- EWALT, J, PARSONS, E H, WARREN, S L, and OSBORNE, S L *Fever Therapy Technique* New York, Hoeber, 1939
- GIBSON J G, KOPP, I, and SOLOMON, H Physiology of artificial fever changes in blood volume and water balance *J Clin Investigation* 17 219, 1938, *New England J Med* 217 805, 1937
- HARTMAN, F W Pathogenesis of lesions following artificial fever In Simpson and Bierman *Fever Therapy* New York, Hoeber, 1937
- KRUSEN, F H *Physical Medicine* Philadelphia, Saunders, 1941
- OSBORNE, S L, and MARKSON, D E Electropyrexia technic of application and therapeutic indications *Ann Int Med*, 12 189, 1938
- PHALEN, G S, PRICKMAN, L E, and KRUSEN, F H Brucellosis spondylitis *J.A.M.A.* 118 859, 1942
- PRUCE, A M Shock in physically induced fever therapy with blood *J.A.M.A.*, 121 935, 1943
- ROSE A S, and SOLOMON, H C Penicillin in the treatment of neurosyphilis (with discussions by Norman N Epstein and Paul A O'Leary) *J.A.M.A.*, 133 5, 1947

one third of their cases followed for one year or more, indicated that this combination is not the optimum treatment for late symptomatic neurosyphilis.

Chorea minor (Sydenham's chorea) is an indication for fever therapy. The percentage of treated cases in which the choreiform movements rapidly subside and disappear is high. Treatments can be given twice a week at a temperature of about  $104^{\circ}$  to  $105^{\circ}$  F., sustained for five to seven hours. It may be necessary to administer six to twelve periods of fever before the desired result is achieved. The presence of rheumatic carditis does not contraindicate the use of fever. On the contrary, carditis appears to be improved by the treatment. Rheumatic fever responds well to elevations of body temperature physically induced. Simmons and Dunn treated 31 cases of rheumatic fever at temperatures varying from  $103^{\circ}$  to  $106^{\circ}$  F. They report complete and prompt relief of joint pains and swelling in almost all the cases. Krusen and his co-workers have treated brucellosis successfully with fever therapy.

Some patients with infectious (atrophic and rheumatoid) arthritis are markedly benefited by the elevation of systemic temperature, but most of them do not obtain substantial relief. Their joints may move more freely and their pains diminish but the gain is frequently only temporary. The technique which we most commonly employ is to elevate the systemic temperature to about  $102^{\circ}$  or  $103^{\circ}$  F. and maintain it there for about two to three hours, twice a week. Patients receiving this type of application are not hospitalized. Results obtained with higher temperatures and longer durations did not seem to be more satisfactory. Arthritis due to brucellosis is benefited by fever therapy, as are other manifestations of brucellosis. Brucellosis spondylitis can be dramatically improved by a few periods of fever therapy.

Some of the chronic skin diseases are as a rule only temporarily improved by mild fever. Temperatures are elevated from  $101^{\circ}$  to  $102^{\circ}$  F. for one or two hours, every day or twice a week. The patients we treated suffered from generalized lesions such as chronic eczema and neurodermatitis. In some cases of asthma, fever therapy appeared to give relief for varying periods of time. Similarly with multiple sclerosis. In both these diseases, occurrence of spontaneous remissions makes it difficult to evaluate the effect of physically elevated systemic temperatures. Certainly when other therapeutic possibilities have proved to be of no avail, fever therapy is worthy of a trial. Shoulders reports that when fever was combined with x-ray therapy in the treatment of malignancy, the results were definitely superior to those obtained by irradiation alone. The patient's temperature was raised to  $104-$



106° F for one hour. He was then wrapped in blankets and irradiated. One to four such combined treatments were given followed by further applications of x ray therapy.

Other diseases which have been treated by means of physically induced fever, with varying degrees of success, include subacute bacterial endocarditis (combined with sulfonamides), lymphogranuloma inguinale, meningococcus meningitis, and neuritis. Favorable results have also been reported in the treatment of some eye diseases such as interstitial keratitis, exudative uveitis, choroiditis, and corneal ulcer.

## REFERENCES

- BAZETT, H. Circulation in pyrexia. *JAMA*, 97, 1271, 1931.
- BIERMAN, W., and FISHBERG, E. Some physiologic changes during hyperpyrexia induced by physical means. *JAMA*, 103, 1354, 1934.
- CARPENTER, C. M., and BOAK, R. A. Thermal death time of the gonococcus at fever temperatures. In Simpson and Bierman. *Fever Therapy*. New York, Hoeber, 1937.
- DOAN, C. A. Differential reaction of bone marrow, connective tissue, and lymph nodes to hyperpyrexia. In Simpson and Bierman. *Fever Therapy*. New York, Hoeber, 1937.
- EBAUGH, F. G., BARNACLE, C. H., and EWALT, J. R. Psychiatric aspects of artificial fever therapy. *Arch Neurol & Psychiat*, 39, 1203, 1938.
- EWALT, J., PARSONS, E. H., WARREN, S. L., and OSBORNE, S. L. *Fever Therapy Technique*. New York, Hoeber, 1939.
- GIBSON, J. G., KOPP, I., and SOLOMON, H. Physiology of artificial fever changes in blood volume and water balance. *J Clin Investigation*, 17, 219, 1938, *New England J Med*, 217, 805, 1937.
- HARTMAN, F. W. Pathogenesis of lesions following artificial fever. In Simpson and Bierman. *Fever Therapy*. New York, Hoeber, 1937.
- KRUSEN, F. H. *Physical Medicine*. Philadelphia, Saunders, 1941.
- OSBORNE, S. L., and MARKSON, D. E. Electropyrexia: technic of application and therapeutic indications. *Ann Int Med*, 12, 189, 1938.
- PHALEN, G. S., PRICKMAN, L. E., and KRUSEN, F. H. Brucellosis spondylitis. *JAMA*, 118, 859, 1942.
- PRUCE, A. M. Shock in physically induced fever therapy with blood. *JAMA*, 121, 935, 1943.
- ROSE, A. S., and SOLOMON, H. C. Penicillin in the treatment of neurosyphilis (with discussions by Norman N. Epstein and Paul A. O'Leary). *JAMA*, 133, 5, 1947.

- SHOULDERS, H. S., TURNER, E. L., and SCOTT, L. D. Observations on results of combined fever and x-ray therapy in treatment of malignancy. *South. M. J.*, 35, 966, 1942.
- SIMMONS, E. E., and DUNN, F. L. Fever therapy in acute rheumatic disease. *Arch. Phys. Therapy*, 20 : 547, 1939.
- SIMPSON, W. M., KENDELL, H. W., and ROSE, D. L. Developments in treatment of syphilis with artificial fever therapy combined with chemotherapy during the past decade. *Brit. J. Ven. Dis.*, 17 : 1, 1941.
- WILSON, G. The cardiopathology of heatstroke. *J.A.M.A.*, 114 : 557, 1940.

## CHAPTER VIII

# SURGICAL DIATHERMY

THE PRINCIPLES UNDERLYING THE USE OF SURGICAL diathermy are the same as those for medical diathermy. The essential difference between the two is that, for surgical purposes, a greater concentration of current is employed in order to produce heat sufficiently intense to cause destruction of tissue. In surgical diathermy, as in medical, the tissues are heated by the passage through them of the high frequency current; the instrument remains cold, except for such warmth as it develops from the heat of the tissues with which it is in contact. In other words, the tissues are destroyed by *convective* heating. In electrical destruction of tissue by the cautery, *conductive* heating is used. The instrument is heated to incandescence by the passage of the electric current and then transfers its heat to the tissue with which it is brought in contact. In electrocauterization, the tissue in immediate contact with the cautery becomes charred or carbonized, the tissues beneath the surface remain comparatively unaffected (Fig 111). Tissue may also be destroyed by the galvanic current or direct current. This procedure is described in the discussion of galvanism (Chapter IX).

Surgical diathermy may be applied in four different ways: (1) fulguration, (2) desiccation, (3) coagulation, and (4) electric section of tissue.

### FULGURATION

In fulguration, the current is permitted to arc from the point of a needle to the surface which is to be destroyed. The apparatus consists of a needle or small metallic ball electrode inserted into a suitable handle, which is connected to the diathermy machine. Either a biterminal or, more commonly, a uniterminal technique may be employed. With the latter, the electrode is connected to the Oudin or Tesla terminal of the machine (Fig 112). Because of the high voltage, care must be exercised not to employ too much current, otherwise arcing may occur between the hand of the operator and the handle into which the needle is inserted or the electric cord connecting it to the machine. The size of the arc depends on the distance at which the

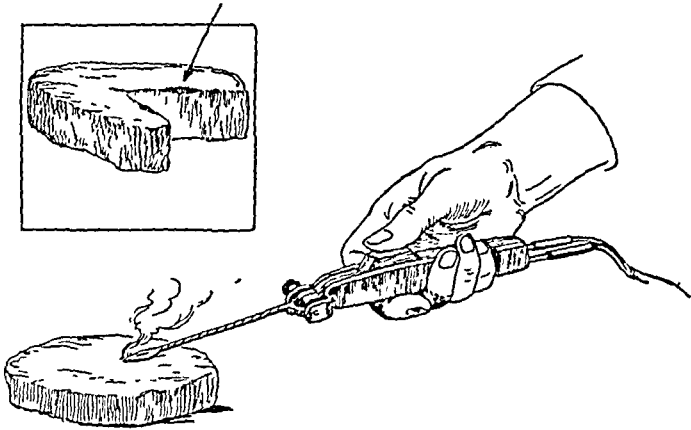

FIG. 111. Cautery. Heated tip applied to tissue. Superficial charring.

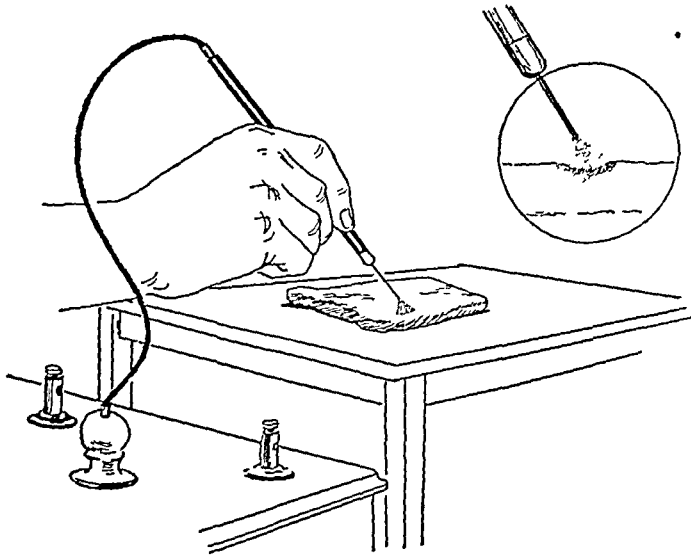

FIG. 112. Fulguration with the direct technique. The needle electrode is connected directly to the Oudin terminal. The destructive action of the current is exerted essentially on the surface.

needle point is held from the surface. The limit of the distance across which arcing will occur depends, in turn, on the voltage of the current. At the usual distance of about one sixteenth to one eighth of an inch, the destructive effect is superficial, only a very thin layer is destroyed. The effect may be observed by applying fulguration to a piece of meat, then cutting across the area with a scalpel to determine the depth of the superficial action. It is a good idea for an operator to familiarize himself with the technique of fulguration, as well as with other surgical diathermy techniques, by practicing on a piece of meat.

Fulguration is used for the destruction of superficial lesions. The area to be destroyed may be exactly delimited. The cosmetic results are excellent, it is frequently difficult to detect the point at which the destructive action of the fulgurating current has been applied after the destroyed layer separates off, that is in about ten days following the fulguration.

### ELECTRODESICCATION

#### APPARATUS AND TISSUE CHANGES

Electrodesiccation is particularly well suited to destruction of small growths in various parts of the body. The current employed is that secured from the Oudin or Tesla terminal of the diathermy machine. The settings are usually so arranged that only a small amount of current enters the machine, if the machine is equipped with multiple spark gaps, only one or two are opened. Otherwise, because of its high voltage, the current may pass directly from the cord and needle holder to the operator. The essential difference between desiccation and fulguration is that in the former the needle is inserted into the growth to be destroyed before the current is turned on. Actually some degree of fulguration also occurs, because as the area becomes dehydrated, arcing takes place between the needle and the tissue immediately surrounding it. The histological changes produced by electrodesiccation have been described by Clark as a mummification of the tissue, the cells become shortened but their outline and nuclei remain discernible. It is possible to produce hyalinization of tissue with intense electrodesiccation.

#### TECHNIQUE

Electrodesiccation and fulguration may be applied by a direct or an indirect technique. In the indirect, the patient is connected directly to the Oudin terminal. This may be accomplished by permitting him to hold a metal bar connected to the machine by an electric cord, or, less commonly,

by placing him on an autocondensation chair or an autocondensation pad which is connected to the Oudin terminal. The applicator, an ordinary sewing needle, is brought near the lesion, and the current is then turned on,

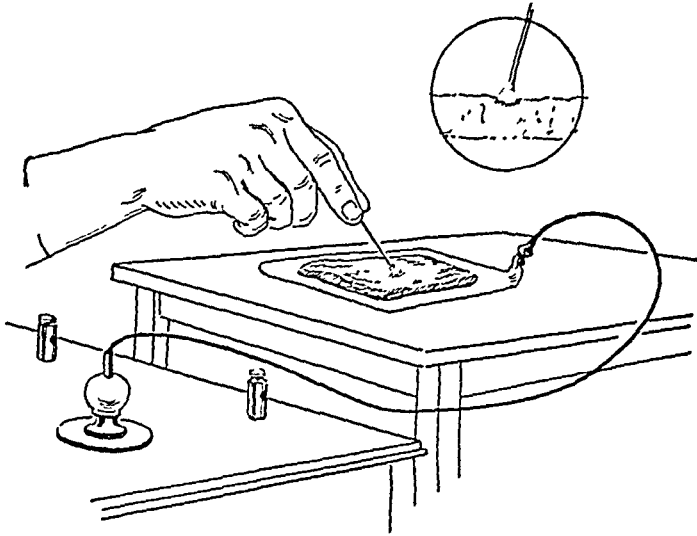

FIG. 113. Fulguration with the indirect technique. The patient—or a piece of meat, as in this instance—is connected to the Oudin terminal. The operator touches the part to be destroyed with the tip of a needle. He should be careful not to make other contact with the tissue. The destructive action is superficial.

preferably by means of a foot switch. The operator must be careful not to touch any other portion of the patient's body; if he does, he will draw the current away from the patient at the region touched. It is possible, too, if the accidental touch be a light one, that arcing will occur, causing an unpleasant sensation to both the patient and the operator. The indirect technique is of value only when the area to be destroyed is small in extent and depth. Its action is a fulgurating as well as a desiccating one. If applied carefully and with a minimum amount of current, it may be employed without the use of a local anesthetic. Very brief applications of the current minimize the discomfort experienced by the patient. This holds true for all forms of surgical diathermy (Fig. 113).

The direct procedure is more commonly employed. In this the needle electrode is connected directly to the Oudin terminal of the machine. The current is turned on and off by a switch on the electrode handle, or, better still, by a foot switch. Before attempting to apply electrodesiccation to a patient, the novice should try the effect of the various settings of his machine on a piece of meat (Fig. 114). As a meter is not available for the purpose, the intensity of the current must be measured by other means. One method is

to note the size of the arc produced between the tip of the needle and some metallic object. If it is too large, the current is reduced, if too small, the current is increased. Another method is to observe the arc and to experience

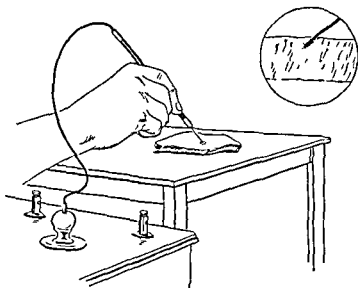

FIG 114 Electrodesiccation Direct technique The needle connected to the Oudin terminal is inserted directly into the tissue to be destroyed The action is on tissue adjacent to the needle

the sensation caused by applying the needle to the operator's thumbnail. The desiccating or dehydrating action of the current may be observed by applying the current to a piece of soap which is covered with a sheet of paper. It will be noted that the soap can be dried out without charring or setting fire to the paper.

*The Operation* The patient is most comfortable when lying on a couch or a table. A goose neck lamp on a floor stand furnishes a good light, or some other method of illumination may be used. Since surgical diathermy is painful, the operative field should be desensitized by a local anesthetic, otherwise the patient may involuntarily withdraw from the instrument. For mucous membranes, a topical application of 2 per cent pontocaine solution is adequate, for the skin, infiltration anesthesia is more satisfactory. After the skin surface is sterilized, 1 or 2 per cent novocain solution is injected into the region surrounding the area to be destroyed. If a local anesthetic is injected into the area itself, the fluid so injected may extend the thermal action of the current beyond the limits desired.

The diathermy machine should be so placed that the operator can change the controls. A foot switch leaves both hands free for the operation. The needle electrode should be sterilized either by boiling or by insertion into

an antiseptic solution. After all connections have been made, the needle is inserted into the area to be destroyed. The color of the tissue changes rapidly as the current passes through it; when it becomes white, the needle should be removed and reinserted in the section immediately adjacent, and this process repeated until the entire area is destroyed. After the growth has been desiccated, it appears "to light up" when, with the current flowing, the needle is held within it. The destroyed area may be removed with a curet to determine whether the destructive action has extended as deeply as desired. Curetting should not be carried below the region destroyed, or bleeding will occur. If any of the growth tissue remains after curetting, the electrodesiccation procedure should be reapplied. The treated area shrinks in size after treatment. If subsequent observations show that removal of the tissue has been incomplete, electrodesiccation may be repeated. This is one of the advantages of surgical diathermy.

*Postoperative Care.* The operation over, the area may be covered with a dry dressing, a bland ointment, or an ointment such as is used in the treatment of burns. Ward recommends a solution of gentian violet. A crust, which separates away in about two or three weeks, forms over the wound. During this time, a new surface develops under the crust of destroyed cells. The color of the new epithelium may be somewhat different from that of the surrounding skin for a short period of time. Occasionally, the region assumes a pink color which may last for months, but eventually it fades. The desiccated area should be inspected within a day or two after the operation to make certain that local infection has not developed. Should infection occur, the crust must be elevated to permit drainage.

#### ADVANTAGES OF ELECTRODESICCATION

Electrodesiccation offers many advantages in the removal of superficial growths. In such procedures, the important consideration, from the point of view of the patient, is the cosmetic one. Ideally, removal of the growth should result in a normal appearance of the affected area. Electrodesiccation fulfills this requirement well, and therefore, it is a particularly desirable method for the removal of growths on the face.

Another advantage of electrodesiccation lies in the extreme exactness with which tissue can be destroyed. This makes the technique applicable, for example, for the destruction of areas about the eye. In treating villous papillomata of the eyelid it is necessary only to apply the desiccating needle to the tips of the villae; the finger-like projections become white to the base from which they arise. This same reaction occurs in all predunculated growths



because the current concentration is more or less equal throughout the length of the growth. Pedunculated polyps can be similarly treated. Corneal ulcers may be desiccated or fulgurated.

A third advantage of electrodesiccation is that it prevents bleeding from the wound. This feature is particularly useful in the removal of growths in vascular areas. For tumors of the mouth, the use of electrodesiccation is ideal. Papillomata on the tongue can be destroyed within a few minutes after the area is desensitized by a topical anesthetic. The dehydrating action of this current is valuable for the desiccation of epulis involving the mucous membrane, and also for other growths on the inner side of the cheek, on the uvula, and on other regions of the buccal mucosa. Electrodesiccation is most frequently employed for the removal of verrucae, all varieties of warts can be destroyed by this agency.

#### ELECTROCOAGULATION

Electrocoagulation produces more intensive destruction than electrodesiccation. It is therefore the better method for destruction of malignant tissue. It is also employed for removal of benign growths that are too large to be conveniently removed by the desiccating current. Essentially the same arrangement is used as in long wave diathermy. In both, electrodes are connected to the two terminals of the circuit. The major difference consists in the fact that in electrocoagulation, one terminal is connected to an electrode with a very small effective area so that the current is concentrated at the region with which it is in contact.

#### TECHNIQUE

*The Large Electrode* In the usual electrocoagulation procedure, a large metal electrode, connected to one terminal of the d'Arsonval winding is attached to any part of the patient's body. The other terminal is connected to a very small electrode which may be either a needle point or a little metal ball held in a suitable holder (Fig 115). The larger electrode—the "inactive" or "dispersive" electrode—should be a plate measuring about 10 by 12 inches. It should be rolled smooth, the edges rounded or turned back, and applied in firm contact with the skin. Care must be taken to make certain that the clip does not press against the skin. Moistening the electrode insures better electrical contact, soap lather or some water soluble jelly should be used for this purpose. On the abdomen or thorax, the electrode may be held in place by sandbags, if it is applied to the back as the patient lies in the supine position, a towel should be inserted between the electrode and the

table. This electrode should be placed as close to the field of operation as is convenient, under the buttocks, upper or lower back, abdomen, and so on. Regions of scar tissue should be avoided. These details are especially

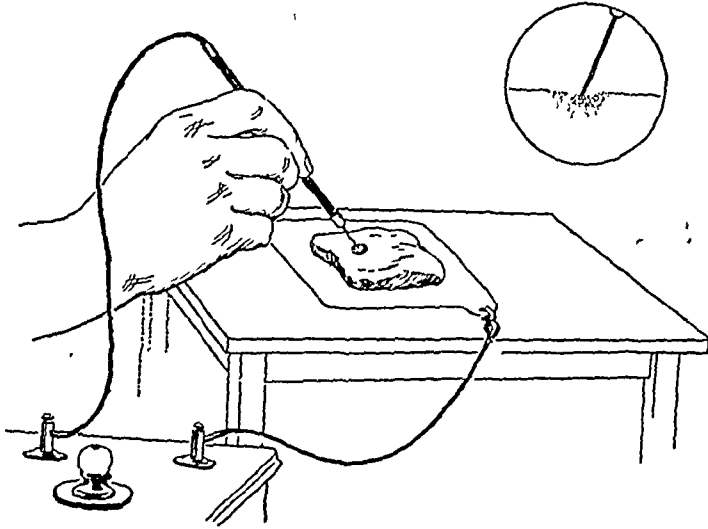

FIG. 115. Electrocoagulation. The technique is a biterminal one. Destroyed tissue may extend for a considerable distance away from the needle.

important when the patient is anesthetized and unable to indicate burning sensations that may arise from overheating.

*The Small Electrode.* The small electrode is called the "active" electrode. It is most often a needle, although it may be a small metal ball or a flat disk. The flat disk electrodes were among those first used by that pioneer in electrosurgery, Doyen. They have been generally discarded because it is difficult to determine the depth to which the tissue beneath them is destroyed when the current is turned on. The ball-tipped electrode is usually applied to surfaces when it is desired to stop bleeding from oozing vessels or from a frank bleeder. Electrocoagulation exerts a hemostatic action on capillaries, arterioles, venules, and small-sized arteries and veins (page 209).

The electromotive lines of force may be represented as a pyramid with its apex at the active electrode and its base at the dispersive one (Fig. 116). The greatest concentration of current is at the apex. There is sufficient concentration of current a short distance from the apex, however, to cause destruction of tissue. The depth to which tissue is destroyed varies with the current strength, the time interval during which it is permitted to flow, the electrical resistance of the tissues, and the depth to which the needle is inserted. A moderate current applied for a long time produces more extensive coagulation than a large amount of current applied for a short time.

In the latter instance, the tissues become dried rapidly and offer a higher resistance to the current flow

*Special Electrodes* The dispersive and active electrode technique may be

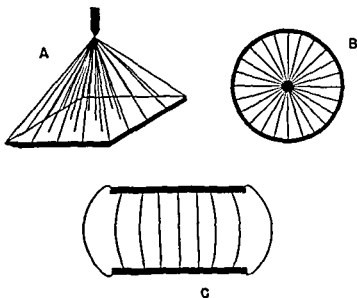

FIG 116 Lines of force in various arrangements employed in electrosurgery (schematic) A Active electrode is used Dispersive electrode is a large plate B Active electrode small and within center of dispersive electrode which consists of a metal ring surrounding it C Two active electrodes held parallel to each other

replaced by one in which two active electrodes are used I have devised a special electrosurgical clamp for this purpose, which limits the electric current to the plane of tissue lying between the active electrodes (Fig 117) The current is not restricted to a straight line connecting these electrodes, but bends outward somewhat, so that its action reaches a wider area than that lying between the electrodes This permits a more exact limitation of the destructive action of the current than does the dispersive active electrode technique When using two active electrodes only a small amount of current is needed, too much current may cause arcing between the nearest points within tissues or within the electrode itself (Fig 118)

Many specially shaped electrodes are manufactured for the application of surgical diathermy to various parts of the body—nose, throat, urinary bladder, cervix, and elsewhere I have designed electrodes for the coagulation of tissue within the body cavities These electrodes, single or double, are held within an insulated tube through which suction is exerted One electrode is small and pointed, and is held in the center of the opening of the tube The other is a narrow ring of metal, which is placed around the first electrode, and separated from it by a short space The open end of the tube is applied to

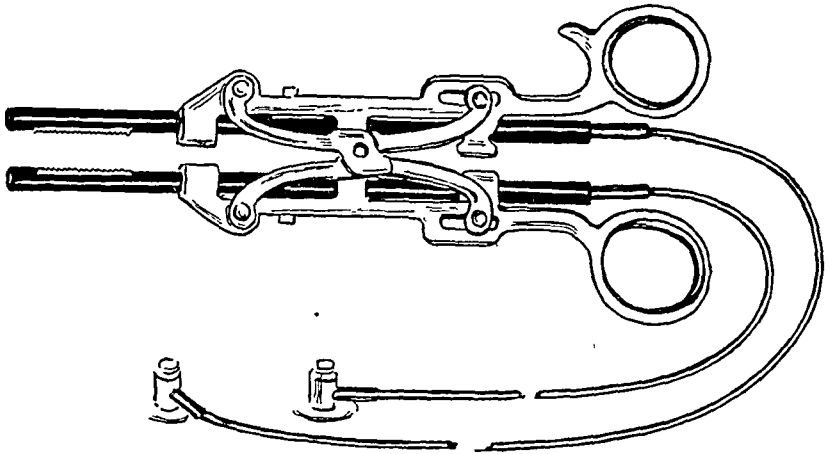

FIG. 117. Hemorrhoid clamp, illustrating the two-active electrode principle.

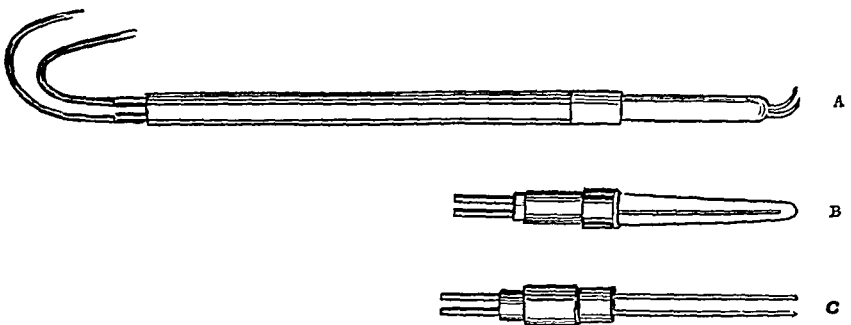

FIG. 118. Forms of biactive electrodes. A. Curved prongs suitable for coagulation of tonsillar tissue. B. Biterminal electrode for coagulation of endocervical tissue C Double needle electrode used in the coagulation of turbinate tissue.

the area which is to be destroyed. The tissue is drawn into the tube and held fast by the suction. This instrument is particularly suitable for the destruction of stubs of tonsil tissue and of growths within the rectum (Figs 119, 120)

As with electrodesiccation the operator should determine the proper setting for his machine by experimenting on a piece of meat. The piece of meat should be moist and its temperature should be about that of the living animal body. If it is held in the hand while the test is made, clinical conditions are more closely approximated. A metal cuff around the forearm will serve for the dispersive electrode (With electrodesiccation this cuff electrode is unnecessary). As the tissue is coagulated, it becomes white, thus indicating the extent of the destroyed area. Such tests with a machine are a better guide than any rule, to the amount of current to be employed and the length of time during which it is permitted to flow.

*Anesthesia* The choice of the anesthetic is particularly important in electrosurgery. Local anesthesia of mucous membrane can be accomplished by topical application of substances like nupercaine, novocain, and butyn. When anesthetic solutions are to be used, they should be injected around the area to be operated on, or nerve block should be performed. For general anesthesia, avertin, or spinal, sacral or caudal anesthesia are the most satisfactory. Ethylene and cyclopropane should be avoided as even in weak concentrations they may explode if they come in contact with a spark. So may ether unless special precautions are taken. The operating field should be shielded from the anesthetist. The operating room should be well ventilated. Care must be taken not to spill the ether or to permit empty cans to remain. Administration by means of a mask avoids the danger of the drop method. The danger is increased if the region operated on is close to the respiratory tract. Chloroform or nitrous oxide are safer anesthetics than ether for electrosurgery.

#### HISTOLOGICAL CHANGES

According to Clark, the histological change occurring in tissue during electrocoagulation is hyalinization. Microscopically, the tissue appears as a homogeneous mass, cell protoplasm, cell membrane and cell nucleus cannot be differentiated. Our own observations indicate that the character of the histological change depends on the intensity of the current concentration rather than on its special characteristics. Mild coagulation produces histological changes resembling those described in electrodesiccation (page 201). Like electrocoagulation vigorous electrodesiccation produces hyalinization

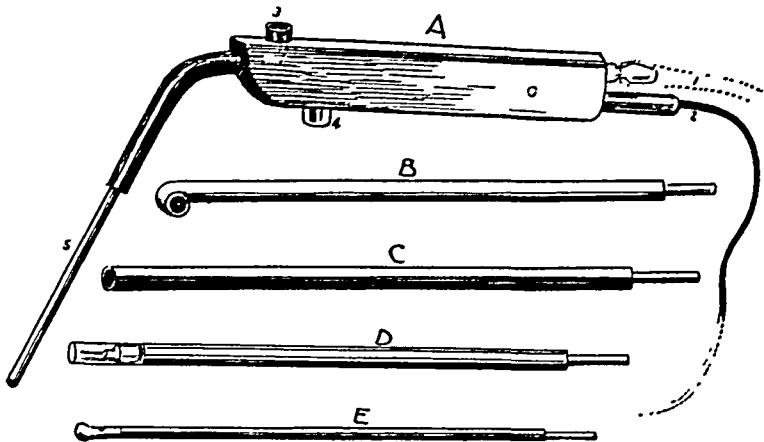

FIG. 119. Suction electrode with interchangeable tips. *A*. Electrode in holder. 1, Tube for suction; 2, electrical connection to machine; 3, opening to air. *B*. Electrode with opening at right angle to shaft. *C*. Straight electrode. *D*. With transparent (lucite) tip. *E*. With suction openings on side of metallic tip.

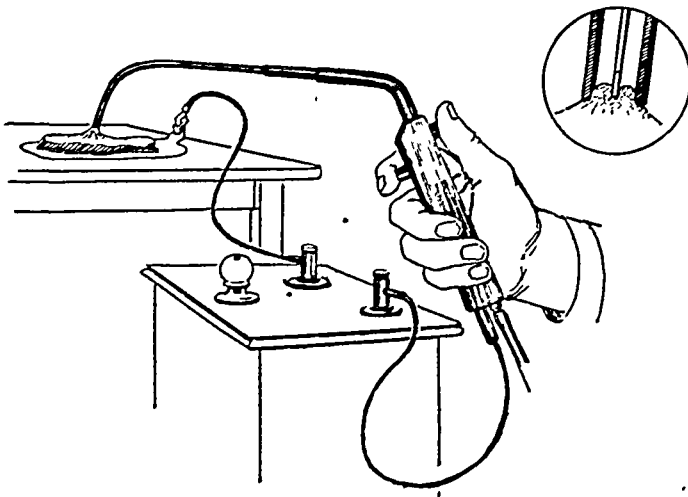

FIG. 120. Tissue to be destroyed is drawn into mouth of suction electrode. The insert shows schematic cross section indicating electrical contact. The technique is a biterminal one to produce coagulation.

of tissue Nieden has described an outer zone surrounding the area of hyalinization, in which there is infiltration with round cells, fibroblasts, and foreign body giant cells

Electrocoagulation may be of great value in some major surgical procedures Separation of the coagulated material takes place within two to four weeks When a large blood vessel is coagulated, there is danger of postoperative hemorrhage during the course of the second week Bone can not be coagulated Cartilage heals very slowly after destruction by high frequency current

## THE CUTTING CURRENT

### TECHNIQUE

The cutting current is supplied by a special attachment made for the ordinary long wave diathermy machine, or from a special unit For this purpose a needle or flat blade electrode is attached to one terminal of the machine The other terminal is connected to a dispersive electrode placed anywhere on the body To the uninitiated it is astonishing to see a dull needle edge cut through a piece of meat as effectively as a very sharp instrument would (Fig 121) The cutting power is due to the arc developed by the high frequency current Its great advantage, as compared with the surgical scalpel, lies in the fact that the tissues on either side of the incision can be coagulated as the cut is made By changing the settings on the machine, the depth of coagulation can be varied from a thickness of 0.1 to 1.0, 2.0, or more millimeters The energy required varies with the character of the tissue to be cut Scar tissue, fat, and cartilage require more energy than muscle does If the field is moist because of the presence of *serum or blood*, more power is needed to make up for the current lost in transmission through the fluid Less energy is needed with a thin-edged than with a thick-edged instrument Fast and deep cutting calls for more power That amount of energy should be employed which permits ready cutting of the tissue to the depth desired The edge of the instrument or the needle point should be used for cutting Surgeons trained in the use of the scalpel often attempt to cut with the side of the blade or needle rather than with its point, the resulting cutting action is not satisfactory because it does not permit sufficient concentration of current It is possible to snare tissue and then to cut it (Fig 122) The electrodes designed for surgical work are needles, flat blades, and wire loops The latter are used for securing biopsy material, for cauterization of the cervix, and for removal of prostatic tissue The cutting may be performed

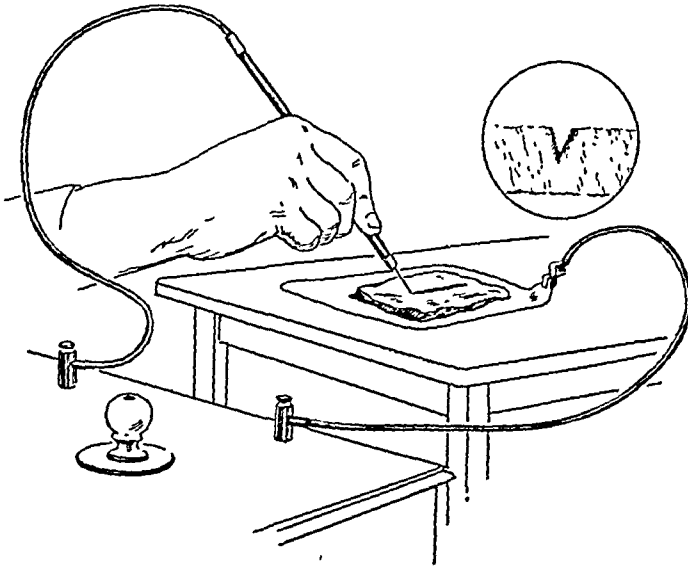

FIG. 121. Cutting current. Technique is biterminal. Width of coagulated area on sides of cut is determined by settings on machine and speed of incision.

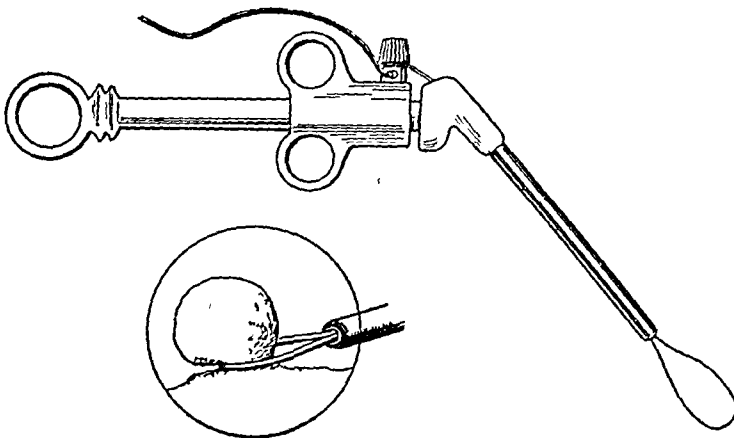

FIG. 122. Cutting with snare.



under water when necessary, as in the urinary bladder and urethra (Fig 123)

*Hemostasis* The wall of coagulation formed as the incision is made is sufficient to produce hemostasis of capillaries and very small blood vessels

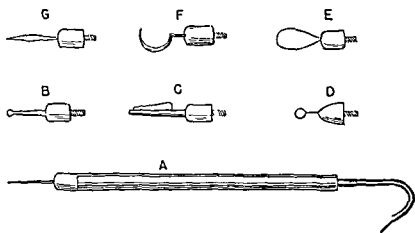

FIG 123 Interchangeable surgical electrode tips and holder A Needle electrode in holder, B ball tip electrode C cutting wire tip (as in coagulation of cervix), D and E cutting loops, F curved needle for coagulating under surface G blade tip

The action of the current is not sufficiently hemostatic to prevent bleeding from the larger blood vessels. These may be seized by the jaws of an artery clamp, and coagulated by allowing the current to flow from the needle electrode to the clamp. A few seconds of current flow is sufficient to cause coagulation of the tissue held with the grasp of the forceps (Fig 124) (Large blood vessels must be ligated). The current should be concentrated in the region of the seized blood vessel. The artery clamp should be held up without undue traction or downward pressure, it should not touch any other part of the body nor any other metal object, as this would tend to dissipate the current. The presence of fluid or blood will also dissipate the current. Therefore the region should be first sponged dry if possible. More energy is required if it is necessary to coagulate in the presence of fluid, and the coagulation extends over a larger region. The coagulated area is also large if this technique is applied in the effort to stop bleeding from large vessels. Too much current can cause rupture instead of closing up of blood vessels. When the coagulum is extensive there is danger of subsequent sloughing. The rate at which coagulated tissue is absorbed is said to be similar to that of an equal mass of catgut. Since the path of the current flow lies between the active and dispersive electrodes, the operator need not fear that the current will pass through him as he grasps the artery clamp.

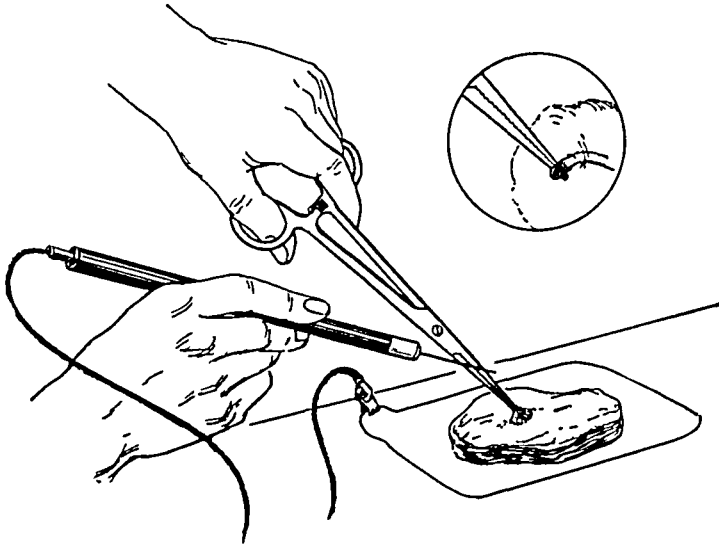

FIG. 124. Procedure for coagulation of tissue contained within grasp of hemostat. This technique, which is employed to control bleeding from small vessels, is a biterminal one.

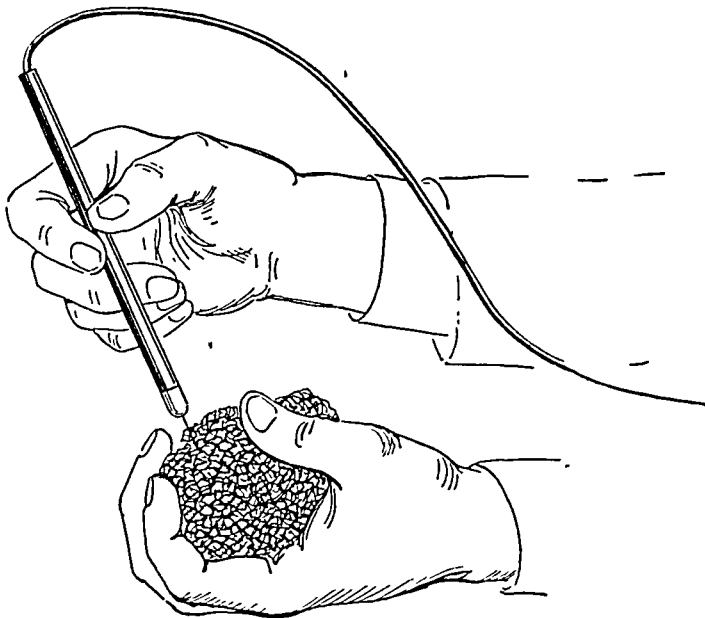

FIG. 125 Method of freeing needle of adherent coagulated matter. Needle is plunged into a wire sponge.

When bleeding occurs, coagulated blood may adhere to the needle electrode, and unless it is removed promptly, the effectiveness of the cutting current will be markedly diminished. An excellent procedure for removing the blood is to stick the needle into a sterile wire sponge of the type sold in hardware stores for cleansing pots and pans. Another method is to scrape the *coagulum* from the needle with some instrument like a forceps. The coagulated blood adheres too firmly to the needle to permit it to be wiped off with a piece of gauze (Fig. 125).

The cutting current may be employed alone or in conjunction with other modifications of surgical diathermy, such as electrodesiccation and, more particularly, electrocoagulation. A combination of the cutting and coagulating currents is the most effective for the surgical removal of new growths.

As with other forms of electrosurgery, it is best to gain experience first by experiments on a piece of meat. It has been suggested that a piece of veal or heart tissue is better than beef because the latter has too coarse a grain as compared with living human tissue. The meat should also have some fibrous tissue, fat, and cartilage. It should not be dried out. If it is, a small amount of salt solution can be injected into it. It will be noted that changing the settings of the machine will produce changes in the width of coagulation. It will also be appreciated that the rapidity with which the cutting is done will influence the width of coagulation. So also will the thickness of the electrode edge. Fibrous and cartilaginous tissues cut with much greater effort than does meat.

#### ADVANTAGES OF ELECTROSURGERY

The surgeon employs surgical diathermy for its hemostatic action, for its greater effectiveness in the destruction of malignant tissue, for the ease of its application in regions otherwise difficult to approach, for its good cosmetic after-effects, and for its sterilizing influence. Its hemostatic action makes electrosurgery particularly suitable for treatment of conditions developing in vascular tissue. It has greatly broadened the scope of the brain surgeon. It has simplified the cutting of kidney, liver, spleen, and thyroid tissue. In gastro-intestinal surgery it performs both hemostasis and bacterial sterilization. This is of special value when cutting through such tissue as the *large intestine in operations for carcinoma*.

The cutting current is particularly effective for operations within the mouth. Tumors of the oral mucosa may be readily removed with little resultant bleeding. The operation for carcinoma of the tongue has been

simplified by application of coagulation and the cutting current. New growths on the lip and face are well suited to electrosurgical procedures.

#### DISADVANTAGES OF ELECTROLOGY

The percentage of wounds that heal by primary union is not so great with electrosurgery as with the scalpel incisions. The narrower the area of coagulation, the greater the likelihood of primary union. This consideration is particularly important in cutting through skin. In the intestinal tract and in muscles, the presence of the coagulated region interferes but little with primary union. Ellis showed that the healing time of electrosurgical wounds is about two days longer than that of corresponding wounds made with the scalpel. During the midpoint of healing, electrically produced wounds showed slightly less tensile strength. A greater amount of serous exudate may follow electric cutting, and it may be necessary to retain drains for a longer period of time if the cut area is extensive. There are certain disadvantages connected with the use of the electric current in surgery. Bone cannot be coagulated. Cartilage can be coagulated, but the coagulated wound heals very slowly. Damage to the periosteum may cause necrosis of the underlying bone with separation of a sequestrum; healing is slow. There is the possibility of damaging adjacent structures in dissection of axillary and similar tissues. Large blood vessels near the field of operation may be injured. When the peritoneum is opened with the cutting current, there is danger of damaging the underlying intestine. The heat produced by the cutting current may cause twitching of a striated muscle.

#### INDICATIONS FOR ELECTROLOGY

Electrosurgery may be used for many conditions in many parts of the body.

Skin:	Infections, benign tumors, malignant tumors.
Oral Cavity:	Benign tumors (papilloma, cyst, ranula, hemangioma); leukoplakia, malignant tumors of lip, tongue, lower jaw and floor of mouth, upper jaw, metastasis.
Otolaryngology:	Nasal polyps, tumors of the nasopharynx, tumors of the ear, tumors of the sinuses, tumors of the sphenoid, tumors of the larynx and bronchi, ophthalmology, ophthalmological lesions of the eyeball (infected infiltrating corneal ulcer, pterygia, epithelioma of the cornea, retinal detachment); eyelid (entropion, xanthoma palpebrarum, chalazion, malignancy); and malignant growths of the orbit.
Thyroid:	Malignancies and toxic goiter.
Thorax:	Severance of pleural adhesions.

Breast	Benign tumors, malignant tumors, so-called inoperable tumors, and metastatic implants
Abdomen	Vascular organs (kidney, spleen—experimental) Gall bladder, appendix, malignant growths, metastasis
Gynecology	Vulva—labia and clitoris Benign tumors, pruritus and kraurosis, chancre, chancroid, venereal warts, carcinoma, Bartholin's glands, Skene's glands Urethra Benign tumors and carcinoma Pelvis Sterility, salpingitis, infected areas on the pelvic wall, ovarian tumors, myomectomy, hysterectomy, endometriosis, malignant or suspected glands, peritoneal implantations, intestinal wall implantations
Urology	Penis Circumcision, chancroid, tumors—benign and malignant Prostate Contractures, bars at the vesical neck, benign hypertrophy, carcinoma Female Urethra Caruncle, prolapsus, granuloma, polyp, sarcoma, and carcinoma Female bladder Ulcers, tumors such as papilloma, papillary carcinoma, or infiltrating carcinoma Ureter, kidney, male bladder Benign and malignant tumors
Proctology	Pruritus ani, hemorrhoids, fissure, fistula and sinus tracts, ischiorectal abscess, papilloma, carcinoma
Central Nervous System	Tumors, abscesses

One of the first uses made of electrocoagulation was for destruction of growths in the urinary bladder. Edwin Beer coagulated such growths many years ago. The flexibility of the procedure is indicated by the fact that growths in the urinary bladder may be destroyed by the aid of instruments inserted through the urethra. A flexible electrode with a ball tip is passed through the operating channel of the cystoscope, and then bent in any desired direction by the deflecting device of the instrument until it is brought into contact with the growth. This is an excellent method for the fractional destruction of benign growths. In the treatment of malignant growths, however, many urologists prefer to expose the field by suprapubic cystotomy and then coagulate all evidences of malignant growth en masse. This treatment can, of course, be combined with the application of radium and of x rays.

Urethral caruncle is a condition which well illustrates the hemostatic advantages of surgical diathermy. It is relatively easy to destroy this type of growth by electrodesiccation or electrocoagulation. A skilled urologist

can destroy the glands of Littre and crypts of Morgagni, with a long, insulated electrode passed through a urethroscope. In the female, Skene's glands may be readily destroyed, killing any gonococci which may exist there. The glands of Bartholin may be similarly destroyed when they are abscessed. An incision is made in the gland with the cutting current, pus is evacuated, and a ball electrode inserted to coagulate the entire lining of the gland.

Carcinoma of the cervix uteri may be coagulated, and then removed by the cutting current; radium and x-ray therapy should follow. In chronic endocervicitis, surgical diathermy has shown brilliant results. This condition may be treated in the doctor's office, thereby making it unnecessary to hospitalize the patient.

Kaplan believes that in malignant lesions in which the tumor mass is fungating, infectious or extremely vascular electrosurgery is a more suitable method of treatment than surgery. He states that although there has not as yet been definite proof that electrosurgery seals blood vessels and prevents entrance of malignant emboli, his clinical observations indicate that such results follow the use of this technique. In the treatment of excessively large growths, he removes the bulk of the tumor and then applies radium or x-ray radiation. He has also observed that coagulation following radiation often prevents hemorrhage from ulcerated lesions further broken down by radium reaction.

It is in the treatment of malignant growths involving the skin that surgical diathermy clearly demonstrates its many advantages. The following technique is commonly employed for skin growths. The malignant area is surrounded by a wall of coagulated tissue (Fig. 126). This "circumvallation," as it has been termed, is accomplished by inserting the active electrode needle into the healthy tissue surrounding the growth. The current is turned on to coagulate the region around the needle. The instrument is then withdrawn and reinserted into the area immediately adjacent. To get beneath the growth, a curved needle is used. After the growth has been surrounded completely with an area of coagulation extending well into the normal tissue, it is removed with the cutting current. With this procedure there is less danger of spreading the growth than when a scalpel or scissors are used; and excessive bleeding is avoided. Electrocoagulation may also be used for destroying benign growths and conditions such as lupus vulgaris. The hemostatic action makes it particularly applicable for the destruction of vascular growths such as angioma.

Surgical diathermy is frequently employed to destroy the hair follicles in the permanent removal of superfluous hairs. The technique is essentially like that described in the use of the galvanic current for the same purpose.

Surgical diathermy has the advantage of speed. A current of about 30 milliamperes may be adequate. The use of a foot switch facilitates the operation. The current is applied for short periods, about a fraction of a second. The

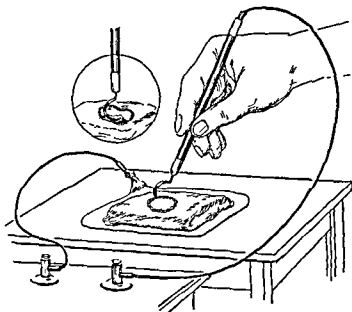

FIG 126 Circumvallation Coagulation by means of multiple punctures. After the area to be removed is surrounded by a wall of coagulated tissue the cutting current can be employed to separate the enclosed tissue.

discomfort experienced by the patient is comparatively slight, particularly if the current is applied intermittently for brief intervals. Practically no scarring occurs whether an insulated or non insulated needle is used. This technique is illustrated in Figure 309 and described in the chapter on dermatology (page 611).

Electrocoagulation and the electric cutting current are also used to eradicate malignant growths in areas of the body such as the breast. They may or may not be used in conjunction with the scalpel and scissors for the initial skin incision and for the dissection of involved lymph glands. Subsequent application of radium or x ray is a common form of after treatment.

#### REFERENCES

- BEER, E. Tumors of the bladder *Surg Clin North America*, 3 423, 1923  
 CLARK, W. L., DOUGLAS, J. M., and ASHIS, E. J. Electrothermic methods in the treatment of neoplasms and other lesions, with clinical and histological observations *Radiology*, 2 233, 1924  
 WARD, G. E. Proper technique in electrosurgical methods *Arch Phys Therapy*, 7 379, 1926

## CHAPTER IX

# GALVANIC CURRENT

**I**N MEDICINE THE TERM "GALVANIC" IS GIVEN TO THAT type of electric current which is also known as "direct," "constant," or "unidirectional" current. This word is derived from the name of the man who first described animal electricity in 1791, Luigi Galvani. For therapeutic purposes, the current may be permitted to flow continuously or it may be interrupted. The continuous current is employed essentially for its electrical properties, and as a method of transferring ions into human tissue; when concentrated, it destroys tissue. We shall first consider (1) the direct uses of the galvanic current; (2) its use as a means of introducing chemicals (iontophoresis); and (3) its destructive effects (surgical galvanism). Then we shall discuss the use of the interrupted galvanic current in (1) electrodiagnosis of injured muscles and nerves; and (2) stimulation of muscles and nerves for therapeutic purposes. A brief review of the uses of the static electricity concludes the chapter.

### CONTINUOUS GALVANIC CURRENT

#### PHYSICS AND APPARATUS

To explain the essential characteristics involved in the flow of electricity in a conductor it is customary to compare this phenomenon with the flow of water through a tube. The pressure forcing the water on is analogous to the voltage of the electric current. Other synonymous terms are "electromotive force" and "difference of potential."

The rate at which water flows is indicated in quantity per unit of time; for example, gallons per second. Similarly the rate at which electricity flows is expressed in terms of electrical quantity, "coulombs" per second. An electric current conveying one coulomb per second is called a current of one ampere. A current of one ampere when passing through a solution of silver nitrate will cause the deposition of 0.001118 gram of silver per second at the negative pole.



The flow of water through a pipe can be retarded by the resistance it meets, for instance, by roughness of the inner surface of the pipe or by narrowing of its diameter. Likewise, there can be resistance to the flow of electric current. The unit of electrical resistance is the ohm. A column of mercury 106.3 cm long and 1 sq mm across, at a temperature of 0° C (32° F) offers a resistance of one ohm to the electric current.

A pressure of one volt will force a current of one ampere through a resistance of one ohm. This is expressed in Ohm's law which states that the intensity of an electric current varies directly as the electromotive force and inversely as the resistance. The formula expressing these relationships is

$$\text{Current (amperes)} = \frac{\text{electromotive force (volts)}}{\text{resistance (ohms)}}$$

The apparatus used for the application of the galvanic current may secure its energy from the house current. Modern electric installations are generally of the alternating current variety. Direct current was more commonly furnished by electric companies in previous years, it may also be found in buildings containing private power plants manufacturing electric current. In both public and private plants dynamos are the source of the current. Alternating house current can be used after it has been rectified. Dry cell batteries are readily portable sources of the galvanic current.

*Polarity* In properly constructed machines which derive their energy from direct house currents, the possibility of administering a severe shock is minimized. A variable resistance permits adjustment of the voltage and amperage of the current. A meter indicates the milliamperage. Conducting cords connect the moist pads which are placed on the patient to the binding posts of the machine. These posts are marked according to their polarity, that is, positive and negative, and in order that they may register accurately, the machine must be properly connected to the current source. Proper connection can be determined in most machines by short-circuiting the current momentarily, if correct, the needle will move across the face of the milliammeter, if incorrect, the needle will be thrust to the left of the zero point. Should the latter occur, the plug inserted into the wall socket or the one inserted into the machine should be reversed.

Another method of determining polarity is to insert the metal tips of the cords coming from the galvanic machine into a glass of tap water, or, better still, weak salt solution (Fig. 127). When the current is turned on, bubbles form actively at the tip of the cord connected to the *negative terminal* of the machine, comparatively few bubbles will be observed at the tip con-

ected to the positive pole. This phenomenon is illustrated in Figure 128. Its explanation is as follows. The solution contains positively charged sodium ions and negatively charged chlorine ions. The positively charged sodium

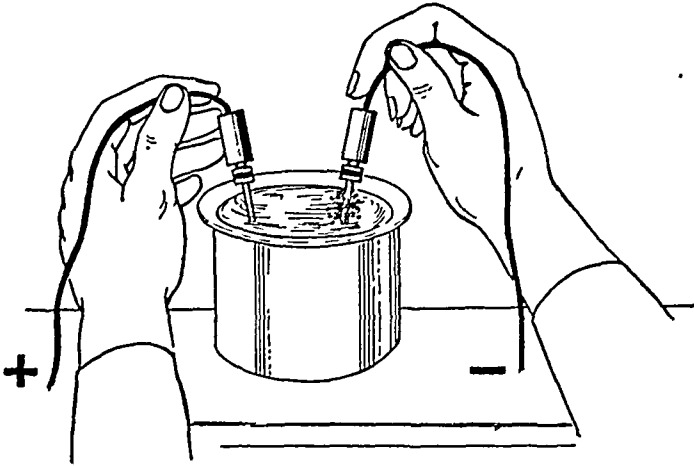

FIG. 127. Testing to determine polarity. The collection of bubbles at the negative pole is larger than that at the positive pole.

ions are attracted to the negative pole. The sodium with its charge lost reacts with water to form sodium hydroxide and hydrogen. The hydrogen is liberated as free gas, forming the bubbles which collect around the negative pole. The negative chlorine ions of the solution are attracted to the positive pole, the anode. Here the chlorine unites with the water to form hydrochloric acid and oxygen. It is this latter gas which is responsible for the

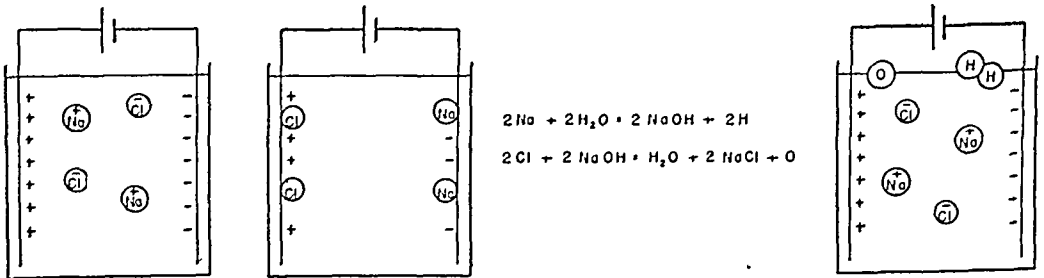

FIG. 128. Electrolysis of salt solution

smaller number of bubbles around the positive pole. Sodium hydroxide and hydrochloric acid react together forming sodium chloride and water. The end result of electrolysis of a salt, therefore, is disintegration of water and no loss of the salt. Because sodium hydroxide is formed at the negative pole, this region gives an alkaline reaction. This can be readily demonstrated if

the metal tip connected to the negative pole is placed on one end of some moistened pink litmus paper, and the positive on the other end. The paper will turn blue at the negative pole indicating an alkaline reaction. Similarly, the tips connected to the positive pole when applied to blue litmus paper will cause it to turn pink, indicating an acid reaction. Many machines are equipped with polarity changers which permit either pole to be made positive or negative.

#### SOURCES OF DIRECT CURRENT

The character of the current from a direct house current source may not be absolutely smooth. Tracings made with an oscilloscope may show frequent minute variations in this current. A shunt resistance installed in the machine reduces the amperage of the house current and makes it applicable for medical purposes. These machines are often provided with induction coils to produce a uniformly interrupted current called the "faradic" current. As with all electrical devices, care should be taken to make certain that when the patient is connected to the machine, he is not also connected to the ground. This would happen if there were an electrical connection between the patient and a water pipe, gas pipe, or steam radiator, or if he were standing on a wet floor or on a stone or metal floor.

Alternating house current may be converted to direct by means of a motor generator or a rectifier. The rectifier is generally employed. When rectified, the alternating current furnishes a good source of galvanic current for ordinary medical purposes. Care in connecting the machine to the wall outlet is not necessary, the polarity as indicated at the binding posts is correct with any method of connection to the wall receptacle. These machines are provided with variable resistances and milliammeters, and designed to furnish a ground free current to the patient. The primary circuit induces a current in the patient's circuit and is not connected directly to it.

The smoothest galvanic current is that derived from chemical sources, that is, from batteries (Fig 129). A good "B" battery is excellent for ordinary purposes. The voltage of commercial batteries of this type is twenty two and one half or a multiple of this number. The battery is usually placed within a cabinet. The instrument panel on the cabinet contains a milliammeter, a variable resistance, and terminals with indicated polarity. Before using the current derived from the battery, one should *make certain that the polarity* as indicated is correct. Galvanic machines depending on batteries for their energy have the advantage of ready portability and smoothness of current.

flow. Their disadvantages are the limitations of current energy which can be secured from them and also the necessity of battery replacement when the current becomes exhausted.

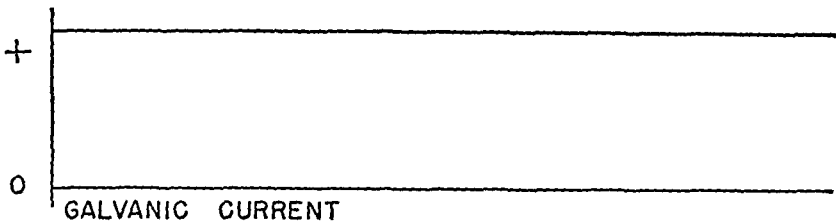

FIG. 129. Galvanic current.

#### PHYSIOLOGY OF THE CONTINUOUS GALVANIC CURRENT

The question arises as to whether interpolar action takes place during current flow to account for possible therapeutic results. Cumberbatch mentions five different effects which occur in the tissues lying between the electrodes when the galvanic current is applied: (1) Vasodilatation occurs in the skin. Cumberbatch attributes elevation of temperature in the popliteal space when electrodes are placed on either side of it (Turrell) to vasodilatation rather than to any heating influence. (2) Electro-osmosis results from transfer of water from the anode to the cathode during the flow of the galvanic current. When the current passes through an electrolyte in solution, the osmotic pressure tends to increase in the vicinity of the cathode and diminish in the vicinity of the anode. Water, therefore, tends to flow to the cathode and diminish in quantity around the anode in order to equalize the differences in osmotic pressure. The possibility of the occurrence of electro-osmosis suggests the manner in which electrodes may be placed to advantage; the anode carrying the positive charge may be placed over the region of effusion, if such exists. (3) The "electrotonus" effect causes a modification of excitability and conductivity of muscles and nerves when the galvanic current passes through them. At the anode this effect is called "anelectrotonus," at the cathode "katelectrotonus." The influence of anelectrotonus can be utilized in the effort to relieve neurogenic pain. (4) The production of counterirritation may explain some of the pain-relieving influence of the galvanic current. This effect resembles the reaction to irritating chemicals which are placed on the skin. In each instance erythema is produced. (5) The "refreshing action" of the current is attributed to the migration of sarcolactic ions from muscle fibers into the blood vessels or lymphatics. This explanation is offered to account for the alleged disappearance of the symptoms of fatigue after treatment by the galvanic current.

## TECHNIQUE

*Electrodes* The galvanic current is applied with moistened electrodes. Metal conductors carry the current from the machine to the solution in

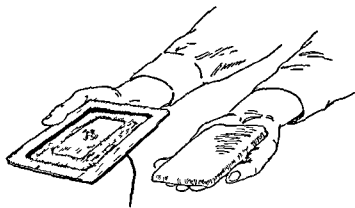

FIG. 130 Asbestos pad electrode and rubber cover

contact with the skin or mucous membrane. The solution acts as an intermediary substance between the metal and the body, thus preventing caustic action in the immediate vicinity of the metal which would cause destructive effects, that is, chemical or electrical burns. The layer of solution must be thick and broad enough to withstand the caustic changes. Most commonly it is applied on a pad electrode, made of some substance which will hold relatively large quantities of fluid (usually tap water or weak salt solution). Towels, a cloth pad filled with asbestos fiber, or other absorbent materials, from one quarter to one half inch thick, make good pads.

Specially designed electrodes are backed with a layer of rubber to prevent the wetting of the clothing or the sheet covering the table top on which the patient may be placed (Fig. 130). The metal conductor extends through the rubber backing to the plate of metal (solid or mesh) which is in contact with the moistened surface of the electrode. If absorbent cotton is used for the pad, it should be arranged in a thick layer, since pressure and moistening will cause a shrinkage. If hand toweling is employed, it should be folded in several layers (Fig. 131). One surface of the electrode is placed in firm contact with the skin of the area to be treated, the other surface is covered with a sheet of metal. The size of this metal plate should be smaller than the wet towel to which it is applied so that there is a rim of moistened material all around it. This is necessary to avoid overlapping of metal with

the consequent danger of burn production, particularly as the current tends to be more concentrated at the metal edges. The pads used should be soaked thoroughly in a basin containing water or weak salt solution. They are then

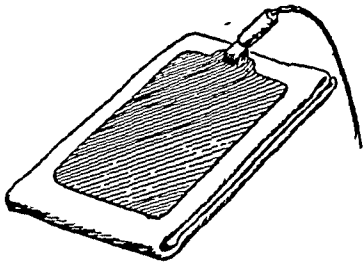

FIG. 131. Electrode made of towel and metal plate.

gently wrung out so as to retain a large quantity of fluid, yet not be wet enough to drip. When the specially constructed rubber backing is not used, a layer of oil cloth or oil silk may be placed over the metal which lies on the moist pad in order to prevent soiling of linen or clothes. The solution in which the pads are soaked should be hot. Under ordinary conditions, by the time the pads are removed from

the water and wrung out, they have lost some of their heat. When applied directly to the skin, they should give the feeling of comfortable warmth. If the galvanic treatment has been preceded by some method of heating, it is particularly necessary that these electrodes be warm in order to avoid causing a chilly sensation. The electrodes may be held in firm contact with the skin by a bandage made of rubber or by sandbags.

A thin sheet of moist asbestos paper may be used as an electrode. This is particularly valuable in administration of iontophoresis when it is desirable to conserve the expensive solutions sometimes used in these applications.

Electrodes equipped with handles are used for electrical testing. The ends applied to the skin may be covered with chamois or with several thicknesses of gauze or similar absorbent material. During use, the tips of these electrodes are dipped into the moistening solution at frequent intervals to make certain that they remain wet. An electrode has been designed in which the tip is kept moistened continuously by capillary attraction from a hollow reservoir contained within it. For the application of the galvanic current to organs such as the nose, ear, eye, and cervix special electrodes are employed.

The galvanic current may also be applied by means of baths in which the entire body or parts of the body are immersed. This form of application is more popular in Europe than in this country. The so-called "Schnee bath" consists of four small porcelain tubs into which the extremities are immersed; the patient is seated on a chair for this procedure (Fig. 132). The bath tub for the treatment of the entire body is made of wood or of porcelain. The current is conducted to the bath through metal or carbon electrodes immersed in the water. In using these baths, particularly the full body bath, the patient must be protected from receiving dangerously large quantities of current energy. He must be cautioned against touching any grounded

metallic object within or outside the bath. Although it is possible to use shallow receptacles containing solution for the application of current to the hands and feet, it is simpler to employ pad electrodes for the purpose.

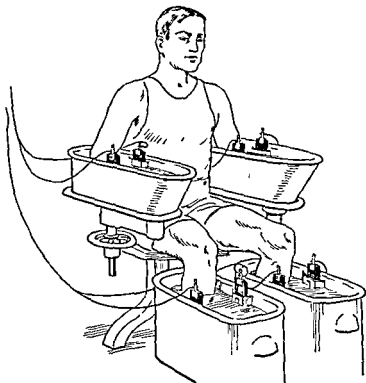

FIG 132 Schnee four cell bath

*Preparation of the Skin* When the continuity of the skin surface has been interrupted, as in regions of open wounds, cuts, scratches, and the like, special care must be taken to avoid concentration of current at these points. The open areas may be covered with some non-conducting substances such as vaseline or a piece of sheet rubber. The part to be treated should be washed with soap and water to remove sebaceous or fatty material, which would cause electrical irregularities by offering greater resistance to the current than the surrounding regions which are free of these deposits.

*Placing of Electrodes* If the electrodes are placed on either side of a relatively small area, as, for example, the region of the knee, there is danger of too great current concentration in the tissues lying between the adjoining electrode edges. If this region becomes moist with the solution which is squeezed from between the two electrodes, this danger becomes still greater. Therefore when the current is applied to the extremities, a large pad electrode should be placed over the lower back, for the treatment of the lower

extremities; or over the upper back, for the upper extremities. The other electrode is arranged to cover a large portion of the surface of the area which one desires to treat. For applications to the torso, the electrodes are usually placed in an anteroposterior position. When applied to the head, one electrode may be placed upon the forehead, and the other on the back of the neck.

*Current Dosage.* The milliammeter on the machine is the best objective measure of the current dosage. Dosage must be adjusted to the disease, the organ, and the area treated. As in the use of thermal measures, the reaction of the patient is also a valuable guide. When the skin is normal, any complaints of the patient of irritation or burning should be heeded promptly, and the quantity of current diminished. At first it is wise to limit the current concentration to about one milliampere for each square inch of the smaller electrode surface. In subsequent treatments, this current density may be increased if the patient can tolerate it. It should, however, be increased very gradually. When first turned on, the milliammeter should register slightly more than zero. As the current is gradually increased, the patient may notice a tingling sensation. If the current concentration is too strong at any one point, a sensation of burning may be experienced; if this occurs, the current should be discontinued immediately. When it is reapplied, steps should be taken to avoid this burning sensation. As the current continues to flow, the initial sensation of tingling may be replaced by one of warmth.

The usual duration of current flow should be from about ten minutes to thirty or forty minutes. At the termination of the treatment the current should be gradually reduced; otherwise painful sensations or shock may result. When the needle on the meter reaches zero, the current is discontinued. Whether the electrode over the region treated is connected to the anode or cathode will depend on the nature of the pathological condition. In general, the cathode is used when there is chronic inflammation, and a stimulating effect is desired; the anode, when a sedative action is desired, as in the presence of pain or swelling.

In acute conditions, the dosage should be comparatively small; in chronic conditions, it may be much larger. There is a considerable variation in the sensitivity of different individuals and in different regions of the same individual. The surface of a special organ like the eye tolerates much less current than the skin does. The pad attached to the negative pole or cathode is usually more irritating than that attached to the positive pole or anode. The resistance to the passage of the current varies in different parts of



the body It is greater when the distance between the electrodes is very long than when the distance is short There is also greater electrical resistance when the current is applied to a part, a cross section of which is relatively small as, for instance, to the hand and wrist In contrast, the resistance is small when the pads are applied to the opposite sides of the chest The relative position of the electrodes makes a difference in the distribution of the electrical energy Thus, if placed opposite each other on either side of the chest, the greatest current concentration will be in the tissues immediately under the electrodes Less current will flow through the region lying between the electrodes and still less in the areas lying outside of this region The skin itself offers much greater resistance to the current than do the tissues lying beneath it At greater depth, the current concentration will become increasingly diminished If the electrodes are applied to either side of a limb in such a manner that their edges lie close to each other, the greatest amount of current concentration will be in the region between these edges

After the current has been flowing for some time, it will be observed that the milliammeter shows an increased reading This is due to the fact that the skin resistance gradually diminishes with the continued application of the current It eventually becomes stabilized at a relatively constant level A subsequent increase beyond this level may indicate a further lowering in resistance, such as that which can occur during the formation of a burn Therefore, the area beneath the electrode should be immediately examined To avoid the current concentration that may occur if the pad dries out in spots, it should be thick enough and moist enough to withstand prolonged application

#### INDICATIONS

The continuous galvanic current is sometimes used for the treatment of neuritis Pain along regions of nerve distribution, as in the so called "brachial neuritis" of the upper extremity or "sciatica" of the lower extremity may be ameliorated (Fig 133) Frequently, however, as might be expected, because of the varied etiology of these symptoms, the pain is not relieved This treatment has also been recommended for pain and swelling following injury—bruises, sprains, and damage to soft tissues occurring in fractures and dislocations Some workers have felt that the beneficial results obtained with iontophoresis can be attributed to the galvanic current itself rather than to the special chemicals employed

The galvanic current is applied to the head to produce an "electric shock" in the treatment of psychically disturbed patients. The procedure is described in the chapter on neurology and illustrated in Figure 278.

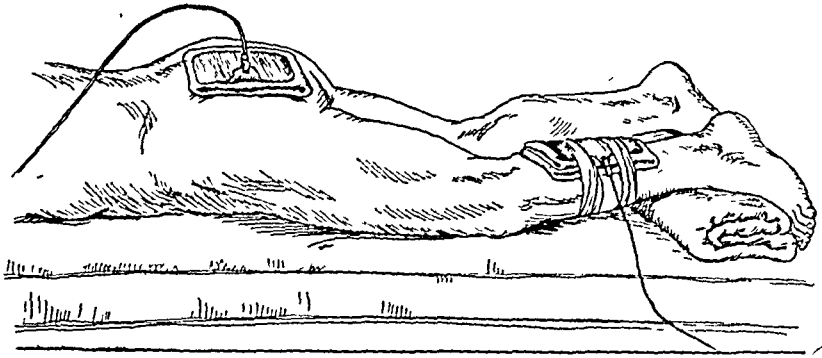

FIG. 133. Galvanism along course of sciatic nerve.

### IONTOPHORESIS

The words "ionization" and "iontophoresis" are used synonymously to denote electrical transference of chemical substances. The latter term is more accurate because it is derived from the Greek, meaning the "carrying of ions." With the facilities available for the administration of drugs subcutaneously, intramuscularly, intravenously, and through the alimentary canal, the advantages of introducing substances into the skin and mucous membranes by means of electricity may not be obvious. They are, however, threefold: (1) it is possible to introduce the desired chemical directly into the involved region of the body surface without the intermediary processes required when it is injected; (2) it provides a means of systemic medication through yet another portal ready of access; and (3) it creates a deposit of a chemical substance from which systemic absorption is relatively slow.

That drugs may be successfully introduced into the superficial layers of the skin by means of the electric current has been proved by numerous experiments. When a solution of histamine is electrically applied to the skin, it causes a wheal and erythema. When zinc sulphate solution is similarly applied to an open wound, it produces a white discoloration due to the formation of zinc albuminate. These evidences of the action of the current are not reproduced when similar solutions are merely placed in contact with the tissues. The possibility of the diffusion of chemical substances merely by contact, is inadequate to explain the occurrence of these phenomena. Harpuder and his co-workers have shown by histological method that it is possible to introduce chemical substances (methylene blue) into the super-

ficial layers of the skin by means of iontophoresis. The evidence indicates that the ions penetrate only a very short distance beneath the surface. However, absorption that occurs from this depot produces the systemic effects.

Proof of the production of systemic changes by iontophoresis is seen in the generalized reaction following the application of histamine over a large area for a sufficient length of time. Similarly, a systemic effect can be secured by iontophoresis with acetylbetamethyl choline chloride. The systemic effect of ephedrine can be secured by electrical application of the drug to the skin surface.

Electrical transfer of substances into the skin and mucous membranes is possible only with chemicals which dissociate, for example, sodium chloride. When salt dissolves in water, its molecules separate into atoms of sodium and of chlorine, which become ionized, the sodium acquires a positive and the chlorine a negative charge of electricity. Copper sulphate, zinc sulphate, silver nitrate, and many other chemical compounds can be similarly dissociated. These substances are called electrolytes, and in solution readily permit passage of an electric current. Ordinary tap water usually contains some electrolytes and thereby becomes a conductor of current, though not a very good one. Distilled water is, of course, a non-conductor. When a galvanic current is passed through a solution of electrolytes, migration of ions takes place: the positively charged ions are repelled from the positive pole and attracted to the negative pole, the negatively charged ions are repelled from the negative pole and attracted to the positive pole. Such a migration takes place when an electric current is passed through a solution of electrolytes applied to the surface of the body. The depth to which this migration takes place depends on several factors. One is the magnitude of the electromotive force which is applied, the greater the difference of potential between the electrodes, the greater the distance which the ions can travel. The longer the time during which the current is permitted to flow, the greater the migration. Another factor is the weight of the ions, elements of low atomic weight migrate faster than those of high atomic weight, everything else remaining the same. In an experiment with agar jelly prepared with litmus, the hydrogen ion was found to have traveled 10.8 mm. in one hour with an expenditure of one volt of electromotive force along each centimeter. Inasmuch as the atomic weight of hydrogen is far lower than that of the chemical substances ordinarily applied in medicine, the possibility of deep ionic penetration with the current strength clinically employed is not great.

The depth of migration is also influenced by the fact that as soon as the ions of the chemicals enter the body, they meet the ions of the body, the

tissue ions. They may unite with these to form insoluble compounds, albuminates, phosphates, carbonates, and so on. Ions which do migrate further and pass through the walls of capillaries and lymphatics may be carried away by the fluids contained within these vessels. Still another factor which militates against the possibility of deep ionic penetration is the tendency of the electric current to spread out as it goes away from the immediate vicinity of the electrodes. The ions will therefore tend to spread over a larger area with a consequent lack of concentration in any one region. All these considerations indicate clearly that the introduction of chemical substances by an electromotive force is limited to the regions immediately contiguous to the surface of the skin and mucous membrane to which these solutions are applied.

In addition to the movement of positively charged ions to the negative pole and of negatively charged ions to the positive pole, there is also a migration of water to the region of the negative pole. This is due to the fact that the hydrogen ion which carries a positive charge and is therefore attracted to the cathode moves with greater velocity because of its light weight. There thus occurs a greater concentration of ions in the neighborhood of the cathode than at the anode. The resulting tendency toward a rise in osmotic pressure in the region of the negative pole is neutralized by the passage of water toward the cathode and away from the anode. This phenomenon can be observed experimentally if two metal electrodes are inserted into a block of gelatine and the galvanic current is turned on and permitted to flow for, let us say, twenty minutes. At the end of that time it will be noted that while the positively charged electrode sticks to the gelatine so that force is required to move it, the cathode falls away as if it had been inserted into soft butter. This migration of water is called "electrophoresis." It may be responsible for the transfer of chemicals to a greater depth of tissue than can be accounted for on the basis of iontophoresis. The electric introduction of drugs into the skin may depend chiefly on electro-osmosis. The reactions to the electrophoretic introduction of chemicals are diffusion, absorption, precipitation, absorption by cells, and transportation by means of lymph and the blood stream. It is suggested that for greatest effectiveness positively charged substances be introduced in neutral or slightly alkaline solutions and negatively charged substances in acid solutions with a pH of less than three.

#### TECHNIQUE

For iontophoresis the smoothest galvanic current is the most suitable. Such a current is best derived from batteries. A "B" battery housed in a suitable

cabinet and connected to a milliammeter and rheostat makes a satisfactory and cheap apparatus which has the additional advantage of ready portability (Fig 134) Its disadvantage is that the battery must be replaced after a while

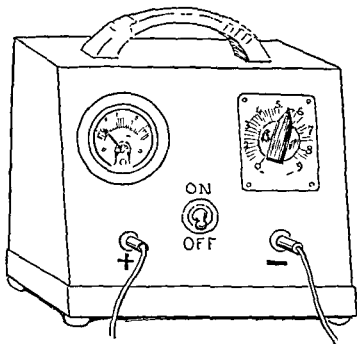

FIG 134 Battery set.

Batteries are usually "dated" Even though not used they lose their charge in about a year However, the number of treatments which can be administered with a battery makes it an instrument of practical value The galvanic current can also be obtained by the conversion of the alternating current with a rectifier or by motor generators Where direct current is available, it can be secured from the house current

As previously described, insulated cords conduct the electric current from the source to metal plates which are placed on moist pads held in firm contact with the surface to be treated

For covering the surfaces of open wounds, the pads may be replaced by small pledgets of cotton which can be placed here and there to fill in an irregular area Also in the treatment of a region such as that about the anal orifice, absorbent cotton can be more readily wedged into the crevice between the buttocks The layer of absorbent cotton should be of generous thickness inasmuch as it becomes thinner when moistened and compressed The metal plate carrying the current is placed against the moistened cotton (Fig 135)

Since some of the solutions used for iontophoresis are relatively expensive, as for example, acetylbetamethyl choline chloride, special asbestos paper pads

have been prepared which are very absorbent but use less solution because of their thinness (Fig. 136). This asbestos paper is tough and will not tear easily, but if the metal plate is placed directly upon it, burns may occur, especially when the treatment is prolonged. Danger of burning is minimized by placing a towel which has been dipped in water, wrung out, and doubled on itself to a thickness of at least one-quarter inch, between the moistened asbestos paper and the metal plate.

The electrode is held firmly in place with a rubber bandage or with weights such as a sandbag. Cloth bandages are not as good as rubber because they may become moist and convey the current to regions outside of the area to be treated. The dispersive electrode should be of larger size than the active electrode. If parts of a pad cover a bony prominence, care should be taken that the pressure at the high point is no greater than on other parts of the pad; otherwise there may be danger of current concentration. The surface of the moistened material placed in direct contact with the skin should be smooth. Wrinkling and ridging may cause undue current concentration with the resultant possibilities of a burn. The skin in the area to be treated should be clean; greasy spots, particularly, must be removed. The operator should assure himself that the region is not anesthetic.

Before beginning the treatment, a glance should assure the operator that the cords, pads, and contacts are properly adjusted. The needle of the milliammeter should be at zero. To insure this, the entire resistance of the rheostat should be in the patient's circuit before the beginning of the treatment. The switch is then turned on. The rheostat knob is turned very slowly so that the increase in current is a very gradual one. If the full force of the current is applied all at once, the patient will experience a painful sensation or a shock which will make him apprehensive, sufficiently so, perhaps, to discourage him from taking further treatments. Likewise, at the end of the treatment, the current should be gradually diminished. Any complaints of a burning sensation should warn the operator to diminish the current. If this proves inadequate, the current should be turned off completely and the skin examined for evidences of undue current concentration. It may be necessary to remoisten the applicator if it has become dry in some one spot.

The polarity of the electrode on which a chemical substance is placed depends on the charge of the ions to be introduced. For example, if it is desired to introduce the copper ion, a solution of copper sulphate is used under the positive electrode. The copper ion is repelled from the positive electrode and attracted toward the negative electrode which is placed at some distance away. If it is desired to introduce a negatively charged ion, as,

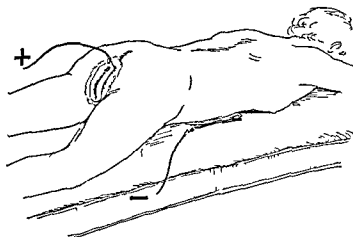

FIG 135 Perianal copper sulphate iontophoresis. A metal plate on cotton soaked with solution is attached to the positive pole. The negative terminal is connected to the dispersive electrode under the abdomen.

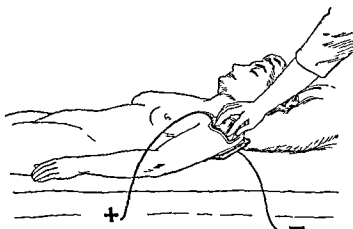

FIG 136 Histamine iontophoresis to shoulder. Asbestos paper soaked with solution and covered with a metal plate is connected to the positive pole. It is held in place by hand for duration of treatment. The negative pole is connected to the dispersive pad electrode on the back.

for example, the chlorine ion, a solution of sodium chloride is placed under the negative electrode. Solutions applied with the positive electrode are copper sulphate, zinc sulphate, silver nitrate, mercury bichloride, magnesium sulphate, quinine hydrochloride, cocaine hydrochloride, adrenalin chloride, histamine acid phosphate, acetylbetamethyl choline chloride. Solutions placed under the negative electrodes are sodium chloride, potassium iodide, and sodium salicylate. These chemicals are usually applied in a solution of 1 to 2 per cent concentration. Good results are reported with a choline solution which has been diluted to one-fifth of 1 per cent. Histamine in a concentration of 1:1000 is adequate. A stock solution in a 10 per cent concentration is diluted when applied, or a fresh solution may be made when required. Ordinary tap water can be used as a diluent but distilled water is preferable. Histamine iontophoresis can be carried out by immersing the treated part in a glass vessel containing the histamine solution into which a metallic plate is inserted. The systemic symptoms which may be produced by this technique can be counteracted with an injection of atropine, if necessary.

Iontophoresis of metallic ions can be accomplished by placing the metals themselves in direct contact with the region to be treated. In endocervicitis, for example, a copper rod is inserted into the cervical canal. When this is connected to the positive pole and an electric current permitted to flow, copper ions are deposited within the mucous membrane, lining the cervical canal. Mercury and zinc may be applied in a similar manner. This procedure is useful in the treatment of narrow channels, such as sinus tracts or natural body passages.

The strength and the time during which the current is permitted to flow varies with different diseases. Thus, in the treatment of corneal ulcer, less than 2 milliamperes is used for only one or two minutes. In parts of the body such as an extremity, 25 to 30 milliamperes of current may be permitted to flow for a period of thirty to forty minutes. In general, it is advisable to cover the region to be treated and a generous portion of the surrounding tissue. This permits the use of a larger electrode and greater current volume. The patient's tolerance is always an important guide. Treatments are usually applied every second or third day, if the reaction which they cause has receded during the interval. When tissue has been destroyed, ten days or so should be permitted to intervene before the treatment is reapplied, so that dead tissue may have time to slough away.

#### INDICATIONS

Iontophoresis with various chemical substances has been advised for numerous diseases. A current concentration great enough to produce destruc-



tive changes may be employed. However, non surgical applications have wider uses. Chlorine iontophoresis is used to soften scars such as those causing contractures. Cotton or cloth soaked in salt solution is applied to the

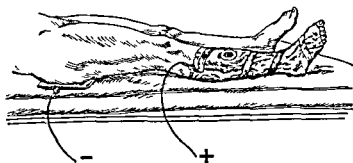

FIG 137 Histamine or acetylbetamethyl choline chloride iontophoresis to region around ulcer. The metal strip is wound around the asbestos paper which is soaked with solution. The negative pole is connected to the dispersive electrode under the buttocks.

scar and connected to the negative pole. Electrophoresis may account for the softening. For all forms of arthritis, iontophoresis has been administered with the ions of salt, salicylic, lithium, iodine, histamine, and acetylbetamethyl choline chloride. Histamine and saline iontophoresis have been applied to sprains, synovitis, tenosynovitis, bursitis, fibrositis, myositis, and myalgias. The use of novocaine iontophoresis followed by active exercise, as advocated by Snow, is a useful procedure in the treatment of sprains, bursitis, low back pain, sciatica, and chronic shoulder spasm. Two to four layers of gauze saturated with a solution of 80 per cent alcohol containing 1 per cent novocaine and 1/20,000 adrenalin are placed on the painful area. These are covered with a towel folded twice and soaked in saline. Generally, a current of about 20 milliamperes is permitted to flow for twenty minutes. In peripheral vascular diseases, such as thrombo-angitis obliterans, Reynaud's disease, and chronic phlebitis, histamine and mecholyl ions are introduced electrically into the skin of the extremities (Fig 137). Some diseases of the nervous system have been treated similarly. In trigeminal neuralgia, iontophoresis has been applied with salt solution, and with ions of aconite, salicylate, and quinine. The use of a 1 per cent solution of aconite applied with a current intensity of 2 to 5 milliamperes for thirty minutes is a favorite European technique. Neuralgias occurring in other sites have been treated in a similar fashion. Neuritis has been treated with ordinary salt solution and also with local anesthetics such as cocaine and nupercaine. Saline iontophoresis has been used for neurological conditions such as hemiplegia, poliomyelitis, and facial paralysis (Bell's palsy).

Diseases of the skin offer a wide field for iontophoresis. Fungus diseases

have been exposed to ionic transfer from solutions such as silver nitrate and copper sulphate (Fig. 138). Zinc ions have been applied to boils, carbuncles, acne, indolent ulcers, and sinuses. In pruritus such as that occurring around

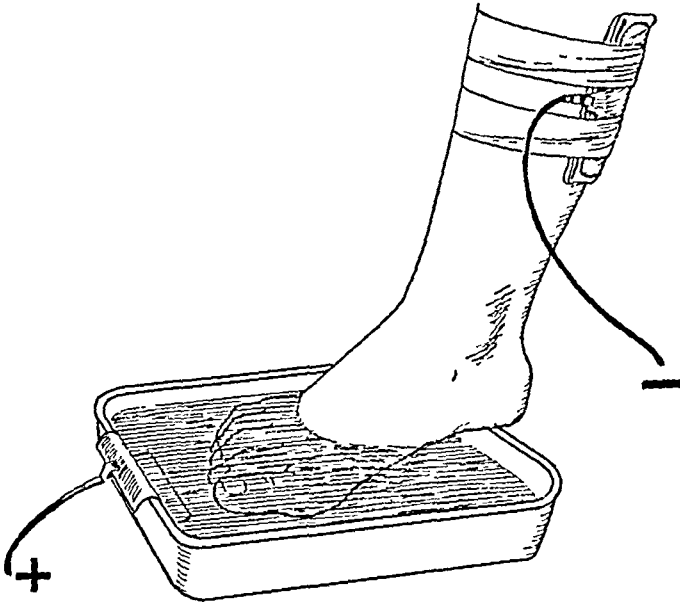

FIG. 138. Copper sulphate iontophoresis to toes. The dispersive pad on the back of the calf is connected to the negative pole.

the anal orifice and the vaginal canal, fungicidal solutions and local anesthetics have been utilized (Fig. 135). Mecholyl iontophoresis has been advocated in the treatment of scleroderma. Magnesium ions have been applied to eradicate multiple warts in localized areas. Magnesium iontophoresis has been advocated for relaxation of muscle spasticity such as occurs in hemiplegia. Other skin conditions which have been treated with iontophoresis include impetigo, tinea, alopecia areata, and eczema. Zinc ions have been extensively applied in the treatment of chronic purulent otitis media, corneal ulcers, hay fever, vasomotor rhinitis, and paranasal sinusitis. Endocervicitis is benefited by iontophoresis with copper or zinc rods inserted into the cervical canal. Iontophoresis has been applied in the treatment of anal fissure, rectal fistulae, and for mucous colitis.

Abramson has employed electrophoresis for administration of epinephrine in the treatment of allergic states. Electrophoresis can be used for making skin tests with pollens. In hypersensitive subjects, wheals appeared after about five minutes with current densities of from 0.3 to 0.5 milliamperes per square centimeter. An apparatus for the simultaneous testing of ten substances has been described.

Electrophoresis has been applied in the co-seasonal pollen treatments of hay fever due to ragweed. The quantity of ragweed introduced intradermally depends on the size of the electrode, the current density, and the

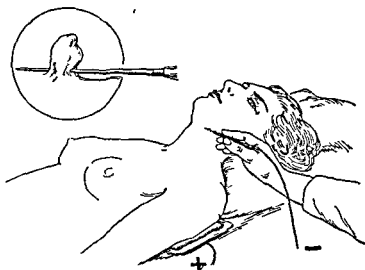

FIG 139 Electrolytic destruction of skin tag. The needle transfixing the tag is connected to the negative pole. The dispersive electrode is placed under the arm.

concentration of the solution. In this treatment, the current is administered in concentrated fashion.

#### SURGICAL GALVANISM

The direct current can be used to destroy small growths and, more particularly, hair follicles. For destruction of growths, both large and small, the galvanic current has been largely displaced by surgical diathermy, it is, however, still employed for the removal of small benign growths. The method is particularly suitable for removal of small skin tags so common in the region of the neck and upper back (Fig 139). The base of the growth is transfixed with a small needle attached to the negative pole of a steady source of galvanic current, preferably a battery. Current with a milliamperage of about 1 or 2 and a voltage ranging from 5 to 20 is sufficient. After an interval of about one-half to one minute, the tissues immediately in contact with the needle become blanched and there is an evolution of gas around the needle. If the skin tag is very small, the needle is then withdrawn. Ordinarily a single insertion is insufficient to cause destruction of the entire base, three, four, or even more insertions may be necessary. The skin tag shrivels, assumes a dark appearance, and falls off within about ten days.

The cosmetic results are excellent. The technique used for the destruction of growths is essentially the same as that for the destruction of hair follicles, described in the following pages. The list of conditions for which surgical galvanism is applicable includes, according to MacKee and Cipollaro, dilated capillaries (as in rosacea, nevus araneus, and following exposure to roentgen and radium radiation), nevi (particularly the spider variety), hemangioma, keratoses, and hairy moles.

#### SURGICAL GALVANISM (ELECTROLYSIS) IN THE TREATMENT OF HYPERTRICHOSIS

The problem of the removal of disfiguring hair in women is a major one, and should be accorded more consideration than it has received by the medical profession. Many women consider such evidence of secondary male characteristics on face and upper lip a major affliction. Because of self-consciousness, they may deny themselves those privileges which are normally enjoyed by members of their sex. The knowledge of how to remove superfluous hairs should be possessed by every physician who has the time, the patience, and the physical equipment necessary for the application of this technique. Unfortunately, there does not, as yet, exist any method for the wholesale removal of superfluous hairs. X-ray radiation is too dangerous; depilators and methods for plucking hairs have only temporary value. Individual destruction of each follicle is the only safe method available at present. Surgical diathermy, which employs both electrodesiccation and electrocoagulation has its advocates. However, the method most frequently used is surgical galvanism.

*Equipment* (Fig. 140). In procedures for removing hair, the physician should allow at least one-half hour for each treatment. Patience, a steady hand, and good vision, with or without the aid of glasses, are prerequisites. The equipment should comprise a table or couch on which the patient is placed, a stool for the physician to sit on, a good source of artificial illumination, and a small table. The galvanic machine to which are attached the electric cords—one connecting the positive terminal with the dispersive electrode; the other, the negative terminal with the needle holder—is placed on the table. A magnifying glass (preferably a Berger loupe), a pair of forceps for grasping hairs, some absorbent cotton, and a bottle of alcohol should also be ready on the table. It is convenient to have the table set on casters to permit it to be moved about readily.

The table or couch which should be sufficiently soft to allow the patient to lie on it in comfort for an hour, may be of regulation height. Some operators prefer to have it low enough to bring the patient's face just above

the level of the operator's lap. The table should be placed so that the operator can sit on either side or at the head. A stool of the rotating type permits height adjustment.

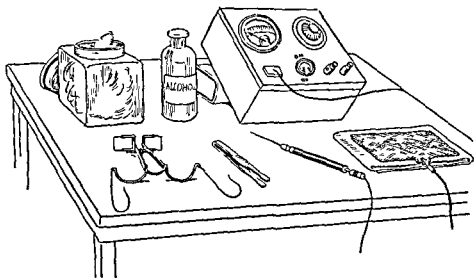

FIG. 140 Apparatus for electrolytic destruction of hair follicle.

It is important to have a good source of illumination. Natural sunlight fluctuates too widely in most regions to be dependable. A 60 watt electric bulb placed in a reflector attached to a floor stand with a flexible goose neck makes a very serviceable instrument. It should be possible to turn the reflector so that the light does not shine into the operator's eyes. A lamp which projects a bright ray on the field of operation may produce an intense light that will irritate the operator's eyes by reflection. The patient's eyes should be protected by a strip of black cloth.

A direct current flowing smoothly is best suited for this work. The galvanic machine employed should be, therefore, of the battery type, a 'B' battery can serve as the current source. I have found it convenient to use eight dry cells connected in series and placed within a portable container. The current is readily controlled by means of a rheostat. The current output is indicated by a milliammeter on the panel of the machine, its range should be small, preferably not more than 2 milliamperes, as this permits of smaller subdivisions and therefore more accurate readings than when the meter covers a larger range such as 25 milliamperes. A switch on the panel board turns the current on or off. A polarity switch permits either terminal to be made positive or negative, the polarity of both terminals should be plainly indicated. To these, the conducting cords are attached. If

there is any doubt, a test for the determination of polarity should be made. To avoid possible confusion, the cords or "rheophores" are usually of different colors: the cord attached to the positive pole is usually red in color; the one attached to the negative pole is green. The cord connecting the needle holder should be light and flexible, and firmly attached to the binding post on the machine; the other cord should be firmly attached to the dispersive electrode.

The dispersive electrode may be constructed in any one of several forms and shapes. The most common is a sponge electrode connected to a handle, which is held by the patient in one hand and pressed against the palm of the other. A wet pad makes another good dispersive electrode. One hand of the patient may be placed on this pad and the contact maintained by a sandbag. Or the pad may be put on some other part of the body, for example, the region of the upper back, where the weight of the patient's body insures firm contact. A simple electrode is made of hand towels folded to present a thickness of about one-half inch. The metal plate connected to the positive cord helps to distribute the current over this electrode. The dispersive electrode should be thoroughly wet with saline solution.

Needles for electrolysis have been made of gold, iridoplatinum, and steel. Those made of steel and iridoplatinum are the most commonly used. Some operators prefer a straight needle, others one bent at an angle of little more than 90 degrees. The end of the needle should be rounded rather than sharply pointed. A bulbous tip further helps to insure against the possibility of penetrating beyond the hair follicle. Thinness of the needle and lightness of the holder and its attached cord make for greater accuracy in the catheterization of hair follicles. If a steel needle is employed, it is imperative that it be connected to the negative pole; otherwise a permanent tattoo mark may be produced due to the deposition of the metal in the skin.

To insure accurate insertion of the needle, magnification is necessary; a Berger loupe is more serviceable than a small magnifying glass attached to the needle holder. A forceps permits firm holding of the hair. A good hair tweezer makes an excellent forceps for this purpose. To cleanse the surface of the skin and to remove material clinging to the needle, I use absorbent cotton moistened with alcohol.

*Technique of Electrolysis* (Fig. 141). The patient should be placed on her back, the lamp so adjusted that the light shines on the region to be treated and away from the operator's eyes, and the seat of the stool raised to a comfortable level. The skin from which the hair is to be removed should be wiped with absorbent cotton moistened with alcohol. If the operator is

right handed, the needle holder is grasped between the thumb and middle fingers of the right hand and steadied by the index finger, as in the holding of a pen. The tweezers are held in the left hand. The little finger and ring

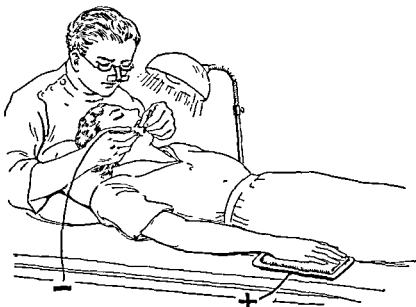

FIG. 141. Technique of electrolysis.

finger of the right hand are held against the skin of the face to brace the hand as it guides the needle point into a hair follicle. The correctness with which the needle is placed in the area of the hair follicle depends on experience. The rheostat handle is turned with the left hand so that the milliammeter on the machine registers between 0.5 and 1 milliamperes, the usual current energy is about 0.7 milliamperes. The patient completes the circuit by placing her hand upon the dispersive electrode.

If the needle is squarely inserted into the follicle a bubbling froth appears almost immediately at the point where the needle pierces the skin. The current is permitted to flow for an additional two or three seconds, and then the needle is removed. The depth of the hair follicle varies from one-eighth to one quarter inch, the depth to which the needle is inserted depends on the length of the hair follicle. The follicle is usually longer with dark, heavy hair than with fine, light hair. The current strength should be adapted to the individual and to the part of the skin that is to be treated. The upper lip, for example, is much more sensitive than the chin or neck, the most sensitive part of the upper lip is the portion nearest to the nose. For such sensitive areas the current should be less than 0.5 milliamperes, its duration should be correspondingly increased. If the hair follicle has been

completely destroyed, a slight pull will remove the hair. If the hair still adheres, it should not be forcibly pulled out; the needle should be re-inserted. After the needle has been removed from one hair follicle it is inserted into another. This second follicle should not be too close to the first; a minimum distance of about one-quarter of an inch should separate the two. If hair follicles close to one another are destroyed, the inflammatory reaction which develops around the follicles may become confluent. With sufficient skill in the catheterization of hair follicles, it is not necessary to discontinue the current between the removal of the needle from one follicle and its insertion into the next. The appropriate level for the current energy should be determined with the first follicle, and maintained for the subsequent follicles. It is advisable to destroy several hair follicles before attempting to extract the first hair, as this gives time for the separation of the destroyed film of tissue which clings to the hair follicle as it is pulled out. Frequently the needle must be inserted on two sides of a hair. While the subsequent scar may be larger than that resulting from only one insertion, actually it is too small to be noticeable. After six or eight hairs have been removed, the area should be cleansed with alcohol. If frothy material adheres to the needle, it can be readily removed by wiping the needle with cotton moistened with alcohol.

A study of hair forms will reveal that for complete destruction of the hair follicle the technique of the insertion of the needle may not be a simple one. For example, the terminal portion of the hair beneath the skin may bend upon itself at right angles; or the follicle may turn and twist somewhat in corkscrew fashion. Under these circumstances it is obvious that a single straight insertion of the needle may be inadequate to remove the hair. A technique to cope with such difficulties is the following (Fig. 142). If, after one or more insertions of the needle it is found that the hair cannot be readily removed, it is grasped with the tweezers, and gently pulled to straighten out the undestroyed portion of the follicle closest to the skin. The needle is then reinserted for a very short distance; and again gentle traction is exerted on the hair, thus straightening the follicle still more. If the follicle is long and twisting, it may be necessary to make three or four insertions before its entire length is destroyed.

Shortly after the hair has been removed, it will be observed that the treated area becomes umbilicated and surrounded by a slightly elevated, pearly ridge. A crust then forms on this region and remains for a period of about five to seven days. At the end of this time, the inflammatory reaction has nearly disappeared. Examinations made subsequently with the unaided eye fail to reveal scarring.



Single treatments usually last from thirty minutes to an hour. During the longer period thirty to sixty hairs may be removed, depending on the operator's skill, the sensitivity of the patient, and the tortuosity of the hair.

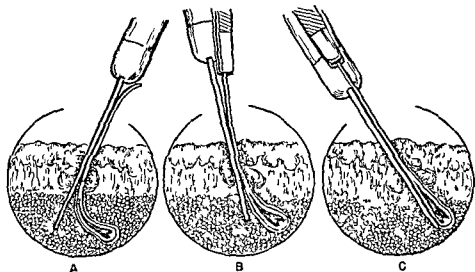

FIG. 142 Method for destruction of curved hair follicle. A Insertion of needle along course of hair. B Reinsertion of needle as hair is straightened with forceps. C Subsequent reinsertion of needle as hair is further straightened.

follicles. When the procedure lasts for one hour, it should be broken by one or two short intervals of rest, since the operation is a tedious one. If the same region is to be retreated at the next visit, an interval of about one week should elapse between treatments, to permit the inflammatory reaction to subside.

At the first visit the patient may inquire as to the number of treatments that will be required for the complete removal of the hair on her face. This question is difficult to answer. A liberal estimate of the number of hairs present, even after a careful scrutiny, may be more than 100 per cent off, as subsequently revealed when the hairs are removed individually. The patient may have employed measures to make her hair appear as inconspicuous as possible.

If a hair has been pulled out, the new hair should be permitted to grow until it is at least one quarter of an inch long before an attempt is made to destroy its follicle by electrolysis. Bleaching, particularly if the hair is fine, increases the difficulty of destroying the follicle. If the mouth of a follicle is difficult to locate, moving the lamp or the angle at which the patient holds her head may bring it clearly into view. If this fails, lamp black may be used to locate the orifice. Lamp black is obtained by exposing a plate to the flame of a candle until a deposit of black has collected. The

lamp black is mixed with a drop of olive oil, rubbed on the skin, and the surplus removed by pressing against the area. The follicular orifices then show up as black dots.

As a rule, electrolysis does not require after-treatment. Should there be some soreness, it may be adequately relieved by the application of witch hazel. Calamine and zinc lotion or mild *lotio alba* will help to allay any unusual inflammatory reaction.

However skilled the operator, there always remain a few follicles which are not completely destroyed. It is stated that from 10 to 20 per cent of the hair may grow again. The assertion that has occasionally been made that treatment may stimulate the growth of hair appears to be unwarranted. In a person who has an abnormal growth of hair, it is not unreasonable to expect that the process will continue with the advancing years. The hairs that are light and small will become larger and more prominent. The only remedy is to destroy each hair follicle that shows abnormal activity.

## INTERRUPTED GALVANIC CURRENT

### ELECTRODIAGNOSIS

The ability of the galvanic current to stimulate muscles and nerves is utilized for the diagnosis and treatment of diseases of these structures. In his original observations which led to the discovery of this form of electricity, Galvani noted that the current caused contractions of excised muscles of the leg of a frog.

In the normal animal body, muscular contraction may be produced by interrupting the current flow as it is applied to the region on the skin surface overlying motor nerves and muscles (Fig. 143). Naturally, more current will be required than if the exposed nerve were stimulated directly because much electrical energy will be dissipated in the intervening and surrounding tissues. The greatest response is elicited with the least current intensity when the motor nerve is close to the skin surface and in the area where its fibers enter into the belly of the muscle. This area is usually near the middle section of the muscle belly.

*Technique of Electrical Testing.* For electrical testing, the galvanic current is secured from the sources already mentioned—from batteries, motor generator sets, rectified alternating currents, or direct house current. Current strength is regulated with a rheostat and measured with a milliammeter. Two electrodes moistened with tap water or with saline are connected to the poles of the apparatus by means of conducting cords (rheophores).

The larger of the two electrodes—the dispersive electrode—may be a

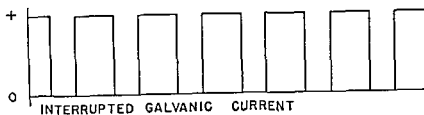

FIG 143 Interrupted galvanism

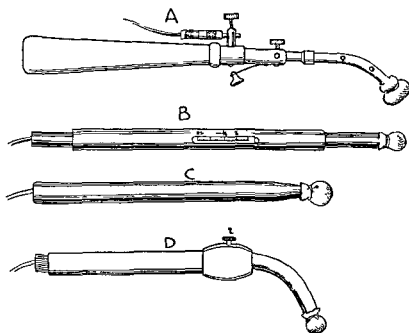

FIG 144 Electrodes used for testing and stimulation *A* Electrode for either continuous or interrupted current flow *B* Electrode with varying pressure and indicated spring tensions Also contains hollow barrel to keep gauze tip continuously moist *C* Electrode for uninterrupted current flow *D* Turning of knurled handle at *1* allows for continued or interrupted current flow, *2* button interrupter

pad about 6 by 8 inches. It should be large enough to prevent current concentration which would cause discomfort. This electrode may be placed on the upper back or chest when testing the muscles of the upper extremity, and on the lower back or abdomen when investigating the muscles of the lower extremity. Or, it may be placed in any convenient region; for example, under the forearm as the patient sits beside the table if the muscles of the hand are to be examined. Similarly, it may be placed under the calf of the leg when the electrical reactions of the muscles of the foot are tested.

The active electrode may be a flat disk about one and one-half inches in diameter or a ball about five-eighths of an inch in diameter. It may be covered with felt, gauze, cotton, chamois, or some other moisture-retaining material, which must be kept moist by frequent insertion into a container of saline solution, or in the electrode so equipped by a moistening chamber (Fig. 144). The active electrode is made to serve as the cathode by connecting it to the negative terminal of the machine. This is done because with a given current intensity, the most active muscular contractions are elicited when the current is closed and the active electrode is charged negatively. If the active electrode is the anode, a greater intensity of current is required to cause muscular contraction when the circuit is closed. Still more current is necessary to cause a contraction if the circuit is opened (i.e., if the current flow is broken). For convenience, these facts are expressed by the formula  $KCC > ACC > AOC > KOC$  (cathodal closing contraction is greater than the anodal closing contraction which is greater than the anodal opening contraction which is greater than the cathodal opening contraction). For practical purposes, that part of the formula is of interest which indicates that the cathodal closing contraction is greater than the anodal closing contraction.

The handles attached to the active electrode are frequently equipped with a spring make-and-break switch. Although this location is convenient for the operator, the motion involved in the manipulation of the switch is readily transmitted to the area of the body on which the active electrode is placed. When a muscle contraction is slight, it may be difficult to distinguish it from the motion imparted to the region by the closing of the switch. For this reason, it is better to interrupt the current on the machine itself, or by a foot switch placed in series with the electrode, or by an automatic interrupter.

A knowledge of neuromuscular anatomy is necessary in order to locate the areas overlying muscle motor points and the regions where motor nerves are sufficiently near the surface of the skin to be stimulated. Special charts and manikins are available for this purpose (Figs. 145 to 153). The active

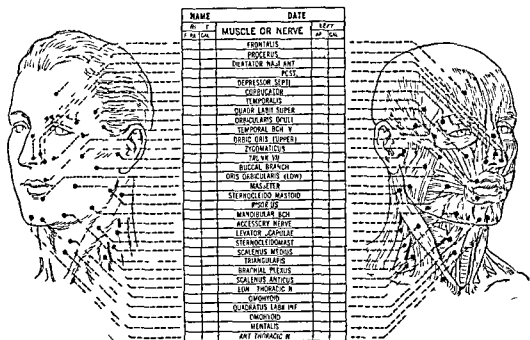

FIG. 145 Motor points of face

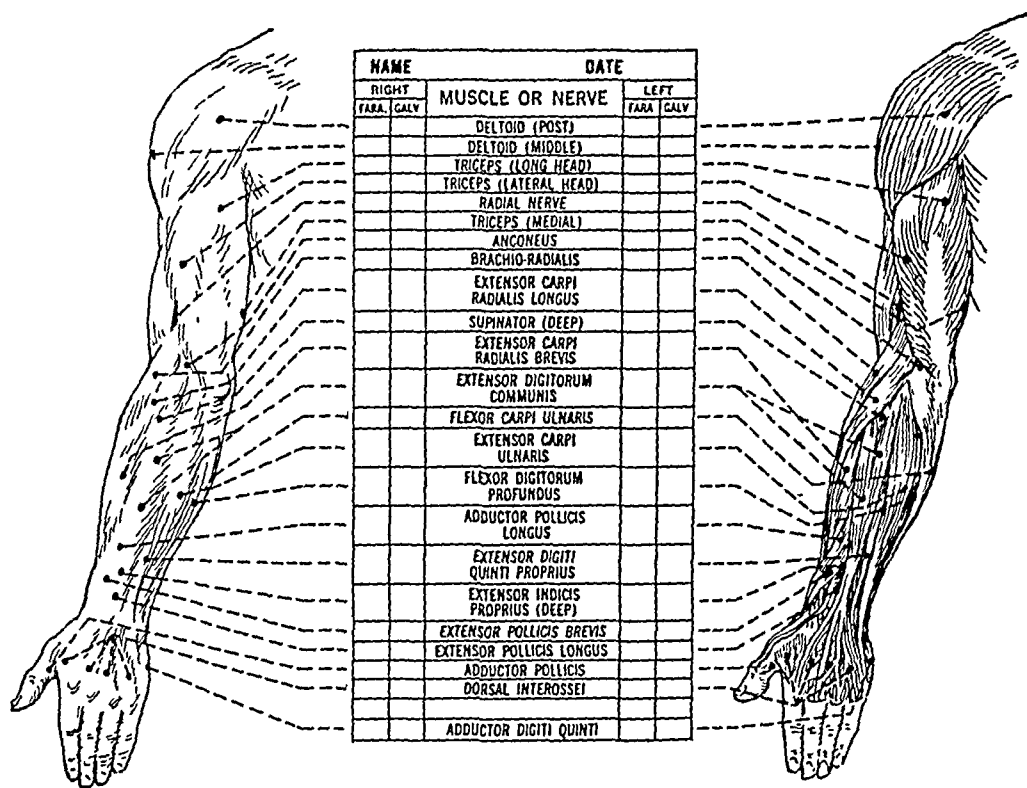

FIG. 146. Motor points of upper extremity. Posterior aspect.

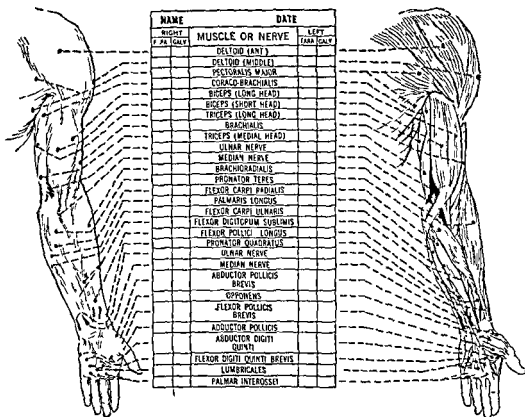

FIG 147 Motor points of upper extremity Anterior aspect

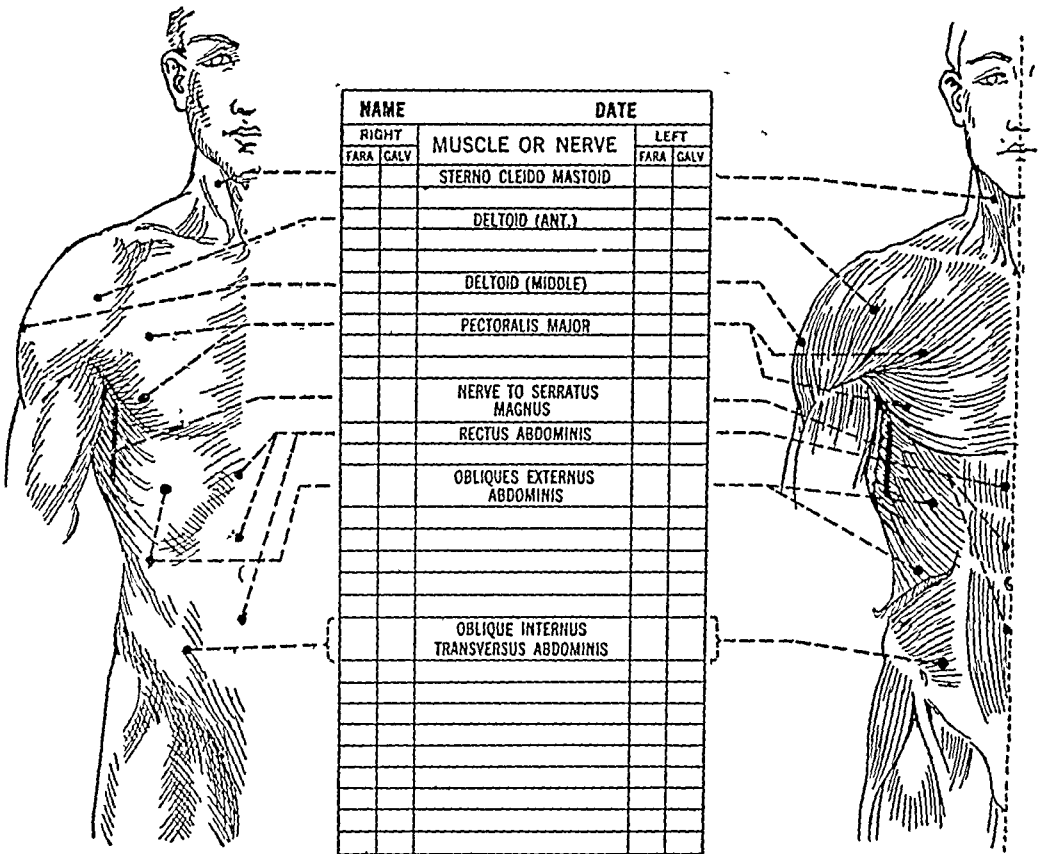

FIG. 148. Motor points of torso. Anterior aspect.



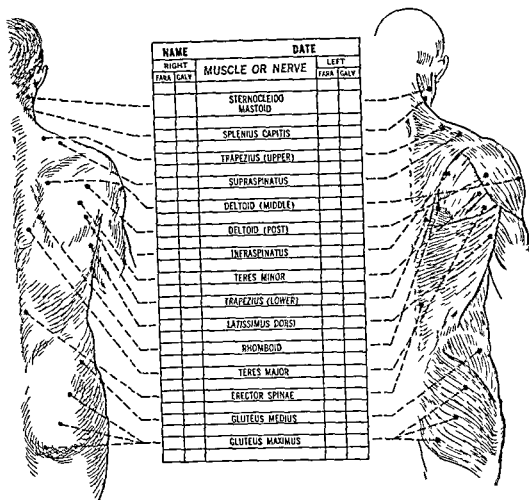

FIG 149 Motor points of torso Posterior aspect.

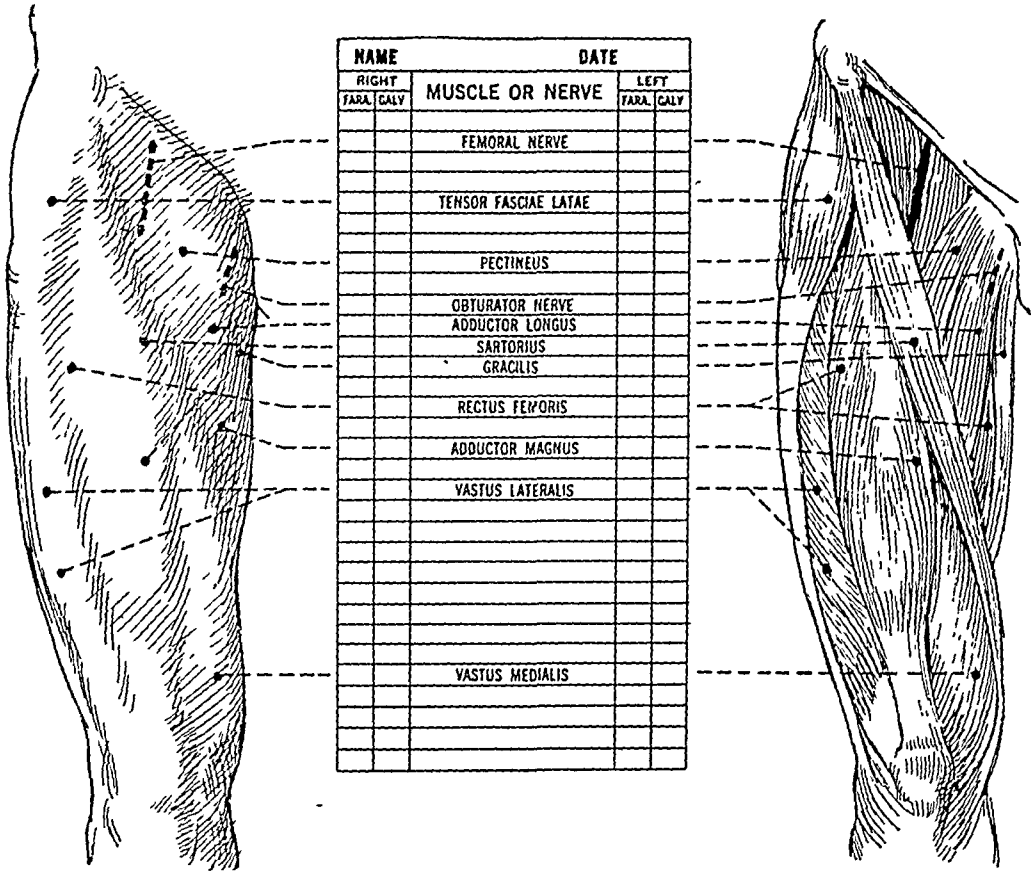

FIG. 150. Motor points of thigh. Anterior aspect.

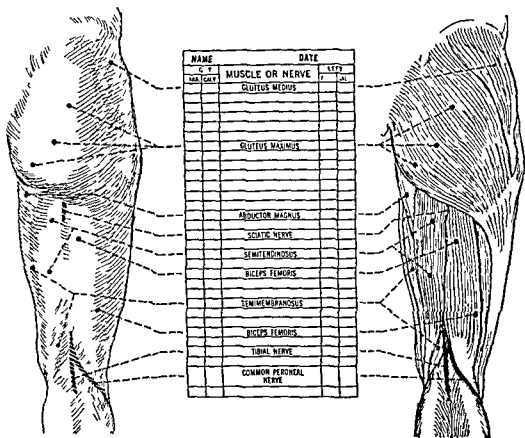

FIG 151 Motor points of thigh Posterior aspect.

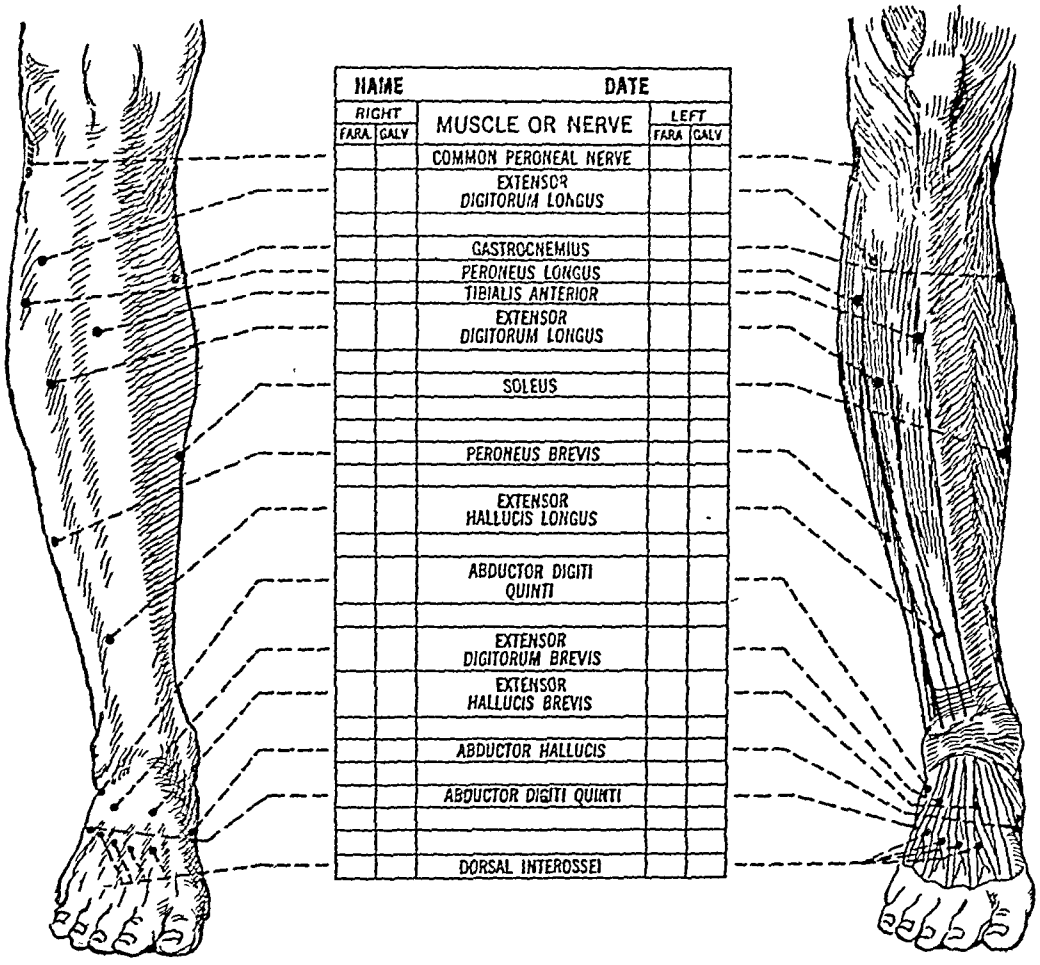

FIG. 152. Motor points of leg and foot. Anterior aspect.

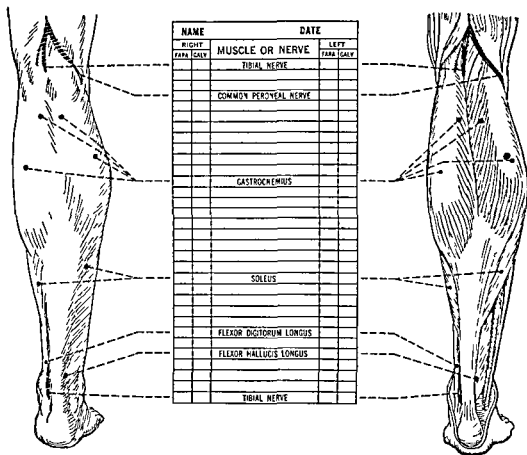

FIG 153 Motor points of leg and foot Posterior aspect.

electrode is placed on the skin in these areas; it is frequently necessary to move it about, in order to determine the region in which the most active contraction of the muscle occurs. Individual variations exist in the location of motor points.

Before applying the current, it is important to make certain that everything is in order; that the apparatus is functioning properly; that the polarities indicated on it are correct, that the cords are firmly attached to the binding posts and to the electrodes, that there is no break in the cord, that the electrodes are well moistened and held firmly in place. The rheostat should be at maximum resistance so that no current passes into the patient's circuit. When the main switch of the machine is turned on, the needle of the milliammeter should be at zero. The rheostat is gradually adjusted so that possibly 2 or 3 milliamperes are indicated on the meter. The patient's circuit is now broken. If no contraction occurs, the current is gradually increased and the process repeated. A good light is necessary in which to recognize a small contraction. When a contraction cannot be seen, it can frequently be felt by placing a finger of the free hand on the region of the muscle or its tendons (Fig. 154). Even when contraction is not discernible, the current should be made and broken several times, because several attempts may produce a contraction with a current intensity too small to cause an immediate reaction. This may be due to the phenomenon called the "summation of inadequate stimuli." It is possible, too, that with the continued application of the current the resistance of the skin diminishes. As the current is gradually increased and then interrupted, the muscular contractions become greater. This response is not a refutation of the "all or none" law; but rather, an indication that more and more nerve and muscle fibers are stimulated. With increase in current intensity, the reaction becomes more painful and more diffuse. In practice, therefore, the lowest intensity that will cause a contraction should be employed (Fig. 155).

When testing normal nerves and muscles, in addition to the consideration of current intensity and polarity of the active electrode, there are several other important factors. These are the temperature of the muscles, the location of the muscle, the duration of current flow between interruptions, the duration of the interval between stimuli, the duration of the entire period of interrupted stimulation, and also the wave form of the current applied. As cold muscle does not react as promptly as one that has been warmed, it is customary to apply heat to a muscle before attempting to stimulate it. Warm water, radiation from a photothermal source, or diathermy will accomplish this. A small lamp is usually the most convenient source of heat.

Muscles in different parts of the body require different electrical inten-

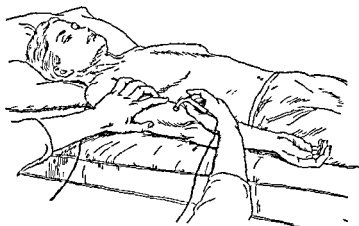

FIG 154 Electrical muscle testing with palpating finger to detect slight contraction

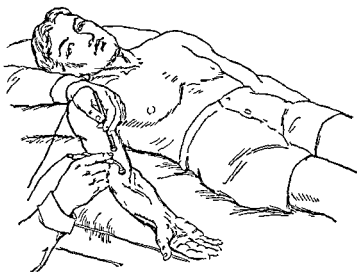

FIG 155 Bipolar electrical testing with displacement of motor point

sities to cause their contraction. For example, the current strength required to cause contraction of the flexors is less than required to cause contraction of the extensor muscles.

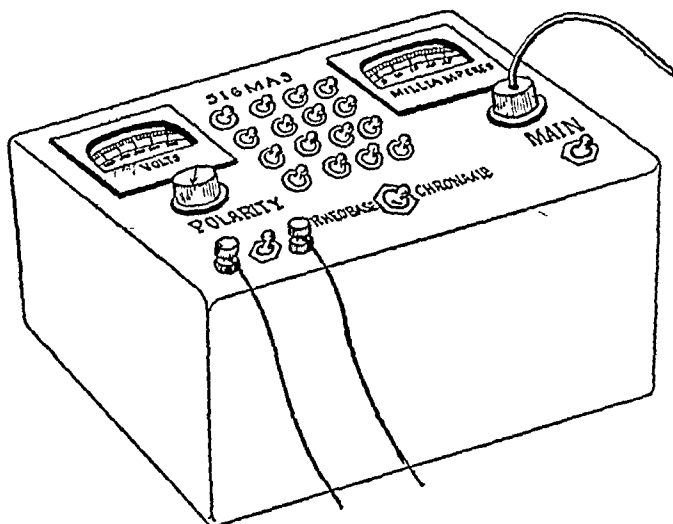

FIG. 156. A chronaximeter.

Duration of the current flow is an important consideration in production of electrically induced contractions. If the current strength applied in order to cause a contraction is high, then the duration of the flow may be very short; if it is low, the duration must be increased. However, there are limits to both current strength and duration, below which no contraction can be elicited. In determination of chronaxie of nerve and muscle, the minimum current intensity must be determined. This is called the rheobase. The current strength is set at twice this value, or double the rheobase. The time during which this current strength flows is then determined in sigmas ( $1/1000$  of a second). A series of condensers in the chronaxie machine permits the application of varying periods of current flow. (Fig. 156). The chronaxie of a given muscle is the time of current flow at double the threshold required to cause a minimal contraction. The chronaxie of normal muscle may vary from  $1/10$  to  $1/2$  of a sigma. Paralyzed muscles may show chronaxies one hundred times longer.

#### THE FARADIC CURRENT

The faradic current is an alternating current (non-sinusoidal) (Fig. 157). When faradic stimulation is applied either to the motor point or elsewhere along the nerve, the intervals between current flow are too short to permit relaxation of the muscles. A tetanic contraction results. The machine which



produces this current contains a uniformly vibrating trembler which rapidly makes and breaks the current in a primary coil. A current of identical frequency and of very brief duration and relatively higher voltage is induced

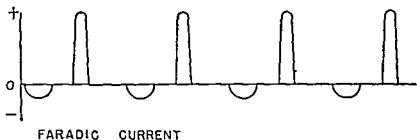

FIG 157 Faradic current.

in a secondary coil. The current duration may be as short as 1/1000 of a second. Apparatus for production of the faradic current may be purchased or constructed as a separate unit. The Council on Physical Therapy of the American Medical Association has prepared specifications for making the faradic coil. Many machines producing the galvanic current and its modifications also generate a faradic current.

The quantity of current in the patient's circuit can be varied by changing the relationship between the primary and secondary coils, or by sliding a soft iron core longitudinally within the primary coil. With this technique rhythmic muscular contractions of muscles may be produced. The vigor of these contractions is determined by the depth to which the core is inserted into the coil. A faradic coil which was used extensively during the first World War and since is that called the "Smart Bristow." Pushing the coil in and out of the machine produces a surging faradic current. At the start of the treatment, the coil is pulled out to its full extent. Smart employed this device to produce gradual muscular contractions. He advocates the use of these rhythmic contractions in the treatment of numerous conditions, including strain, fibrositis, muscular atrophy (from disuse as after fractures, joint and soft tissue injuries), in relaxed abdominal muscles following childbirth, in constipation, to stimulate muscles in conditions such as flat feet, and in arthritis and paralysis due to peripheral as well as central nerve injuries. Menzell has suggested the application of the faradic current to prevent adhesions around a traumatized area, and to assist patients in learning how to contract individual muscles.

The number of contractions produced should be suited to the conditions treated. For example, at the beginning of treatment of a muscle atrophied from disuse, three or four mild contractions may be adequate, this number

may be gradually increased each day. If the rate of stimulation is too rapid, the muscle will be unable to relax between contractions. The reaction of the muscles should serve as a guide to the intensity, number, and frequency of electrical impulses. Tiring is indicated by a sluggish, spasmodic, or vermicular response. Stimulation of one muscle group at a time is to be preferred to stimulation of several by means of large electrodes strapped to the treated part. Vigorous contraction should not be produced when it will aggravate the condition; for instance, following recent trauma.

#### THE SINUSOIDAL CURRENT

The sinusoidal current, as its name indicates, is characterized by the sine shape of the current wave (Fig. 158). This shape can be readily observed on an oscillograph. The current intensity rises and falls gradually. The sinusoidal current may be either unidirectional or alternating. Applied to motor nerves and muscles, it causes gradual contraction and relaxation. The current may be either slow or rapid. When slow, the fluctuations in the current occur about thirty or fewer times per minute. This permits a response in normal muscle as well as in some muscles affected with flaccid paralysis. Because the contraction produced by the sinusoidal current more closely resembles the normal volitional one, it is preferred to the interrupted galvanic current. In many instances of paralysis, however, it is necessary to apply the interrupted galvanic current with its more abrupt make and break because there is an absence of response to the slow sinusoidal current. The rate of change in the rapid sinusoidal current is about one hundred and twenty or more times per second. It will produce contractions of normal muscles, but not of paralyzed ones because the frequency of its change is too great. Its use is indicated, therefore, when it is desired to cause contraction of weakened muscles with intact nerve supply. Combinations of these various currents may be used; for instance, the interrupted sinusoidal and surging faradic (Fig. 159). Other current modifications are the "Lapicque" and the "Leduc." Liebesny believes that the progressive Leduc current of forty interruptions per second is superior to the interrupted galvanic current for stimulating purposes. He recommends the Leduc current in the treatment of the flaccid paralysis that occurs in poliomyelitis and after peripheral nerve injuries.

#### PHYSIOLOGY AND CLINICAL APPLICATIONS

When a motor nerve is completely severed and the muscle which it innervates cannot receive a voluntary impulse, the reaction following elec-

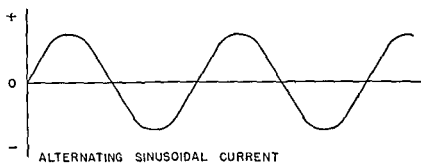

FIG 158 Sinusoidal current

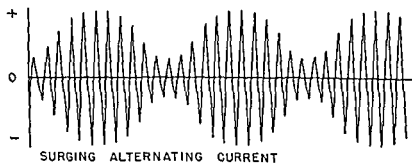

FIG 159 Surging alternating current

trical stimulation of the nerve and of the muscle changes (Fig. 160). Application of the faradic or the interrupted galvanic current to the proximal portion of the nerve does not evoke a reaction. If the injury is old and the

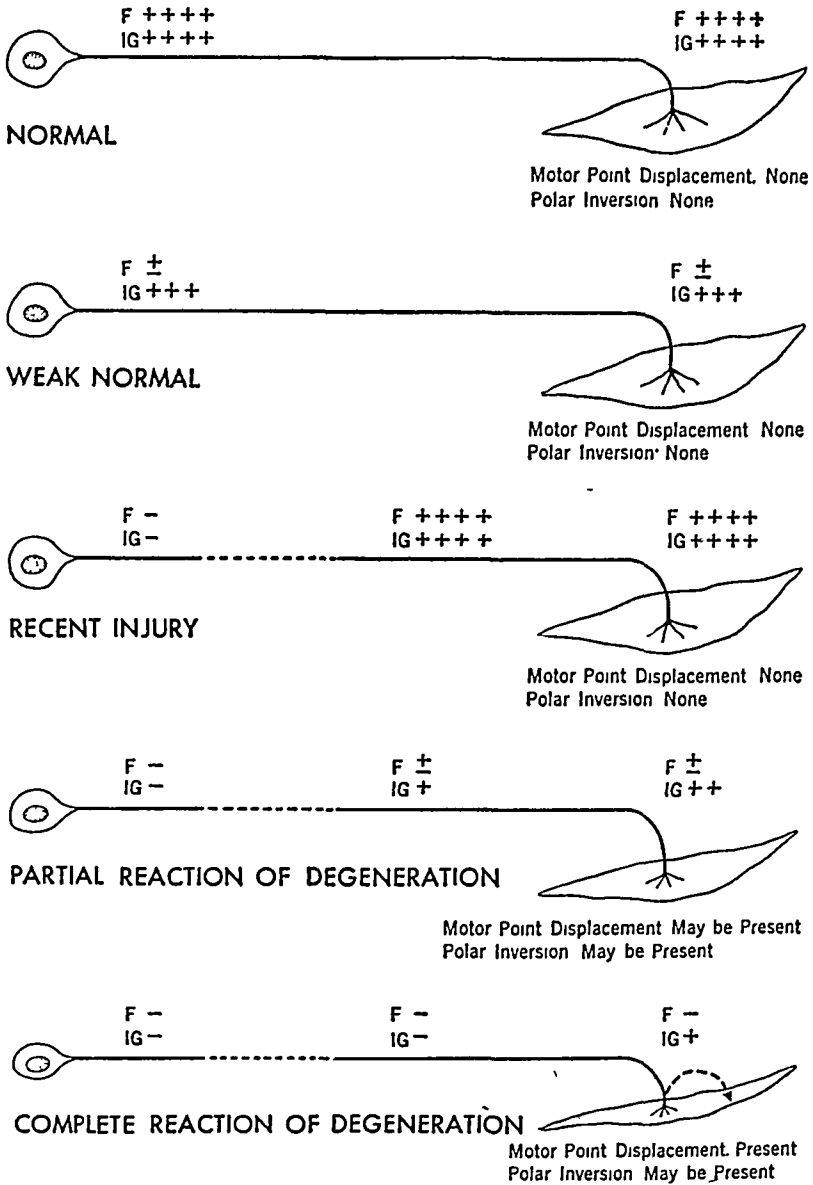

FIG. 160 Electrical reactions of nerves and muscles (schematic). Stimulation with the faradic current is indicated by the letter *F*; stimulation with the interrupted galvanic current, by the letters *IG*. Lack of response is indicated by the minus sign. A positive response is referred to by a plus sign. A plus and minus sign together indicates that a reaction may or may not occur. When the reaction of degeneration is present, the muscular reactions, if they occur, may be sluggish and vermicular.

distal portion of the nerve has undergone Wallerian degeneration, application of the faradic or interrupted galvanic current likewise fails to evoke any contraction. The interrupted galvanic current, on the other hand, if

sufficiently strong will produce contraction. In older lesions the contraction may be sluggish or wormlike. Further, the region of greatest excitability may shift away from the motor point and become longitudinally displaced toward the insertion of the muscle. The anodal closing contraction may produce a greater reaction than the cathodal closing contraction. These changes are known as the "complete reaction of degeneration", during the very early stages, electrical stimulation of the muscle may indicate a hyper-excitability.

When a motor nerve is damaged, the normal nerve muscle electrical reaction may be altered. The form and the degree of the alteration varies with the extent of the injury. For example, when the nerve is stimulated, a contraction may or may not be elicited with the faradic current, and only a sluggish one with the interrupted galvanic. Direct muscle stimulation with the faradic current may or may not cause a contraction. The interrupted galvanic current may produce only a slow and feeble contraction. These changes are referred to as a "partial reaction of degeneration". If the muscle response to the interrupted galvanic current is brisk, even though the faradic response is missing or diminished, the reaction may be called "weak normal". In this instance, there is neither longitudinal displacement of the motor point nor polar inversion.

The failure of the faradic current to cause contraction of degenerated nerve or muscle is due to the fact that the duration of the flow is too short, that is, about  $1/1000$  of a second. Nerve tissue can be stimulated by a current of such short duration, muscle tissue cannot. Muscle tissue requires a stimulus which lasts  $1/100$  of a second or longer. The chronaxie of a muscle with its motor nerve intact may be  $1/2000$  to  $1/25,000$  of a second. When its motor nerve has degenerated, the muscle requires a stimulus lasting  $7/1000$  of a second or longer.

Changes in the electrical reaction furnish objective evidence of injury to a motor nerve, which should be evaluated in conjunction with the clinical changes, such as the site and nature of the injury, the voluntary control of muscles, alterations in sensory symptoms such as tingling and "pins and needles," and variations in the trophic appearance of the part. The presence of such symptoms and signs together with the absence of response to the faradic current indicates nerve injury. If the corresponding motor nerve on the other side of the body is intact, the electrical reactions of the normal side furnish a good basis for comparison. Thus, while the interrupted galvanic current may cause contraction of a normal muscle with from 1 to 5 milliamperes, 10 or 15 or even more milliamperes may be required on the injured side. When the damage to the motor nerve is relatively slight, as

from surrounding inflammation, it may be difficult to distinguish a change in the electrical reactions from that which occurs with a weak normal response

In Thomson's disease—congenital myotonia—applications of the faradic or interrupted galvanic current may produce a contraction which persists after the cessation of current flow. In myasthenia gravis, the contracted muscles may relax from fatigue if the interrupted faradic current has been applied to them for more than a few seconds. Rich's reaction, in which the cathodal opening contraction is greater than the cathodal closing contraction, occurs occasionally when paralysis is due to pressure. Cathodal opening contraction may be evoked with a current weaker than that required to cause cathodal closing contraction. Erb's sign is an increased excitability to electrical stimulation found in tetany; a current strength too small to evoke a response in normal muscle will cause marked and tetanic contractions.

The partial reaction of degeneration signifies that not all of the fibers of the motor nerve have been impaired. The occurrence of the reaction of degeneration indicates that the injury is to the lower motor neuron. It may occur in the anterior horn cells of the cord or anywhere along the course of the motor nerve to its end organs in the muscles. In hemiplegia or other upper motor neuron lesions, the reaction of degeneration does not occur.

If electrical reactions are to be of value in prognosis, the testing must be repeated at regular intervals of time. Even with complete division of a motor nerve, response to faradic stimulation may not cease for from four to ten days. The diminished response to the galvanic stimulation may not begin until about the tenth day after injury. In traumatic lesions local loss of sensation in addition to complete reaction of degeneration is an indication for surgical intervention. If the electrical reactions appear to be normal in paralysis following nerve injury, the treatment should be conservative. So also, if gradual improvement is detected by the changing response to the interrupted galvanic current. After paralysis, the return of the voluntary motor function may occur before the return of the faradic contraction.

## ✓ THERAPEUTIC STIMULATION OF NERVES AND MUSCLES

### PHYSIOLOGY

Chor and his co-workers studied, in monkeys, atrophy and regeneration of the gastrocnemius and soleus muscles, following section and suture of

the sciatic nerve. The animals were given four weeks of treatment, then the muscles were removed and the amount of atrophy determined by comparing the weight of the treated muscles with that of untreated muscles. Chor concluded that atrophy and degeneration of denervated muscle progresses for at least six weeks, despite treatment by passive movement, massage, or electric stimulation. Regeneration and restoration of denervated skeletal muscle occurred with reinnervation. Regeneration of peripheral nerve tissue was about 80 per cent at the end of six months. These workers believe that the degree of nerve regeneration is not influenced by physical measures, but that physical therapy especially massage and passive motion are of value in the restoration of muscle. Other investigators have shown that electrical stimulation delays atrophy of denervated muscle. Wehrmacher observed that the most important factor in treatment is the quantity of tension developed rather than the particular kind, frequency, or phase pattern of the electric stimuli. The total number of stimuli may be small and the duration of the treatment may be brief. Hines likewise noted that if of sufficient intensity to induce strong contractions, electrical stimulation of paralyzed muscles delayed atrophy and enhanced recovery from paralysis. Grodins found that stimulation with a twenty-five cycle alternating current for ten to fifteen minutes daily was markedly effective in retarding atrophy in the denervated gastrocnemius muscle of the rat.

Fisher investigated the effect of faradic and galvanic stimulation on the course of atrophy in denervated skeletal muscles. He resected the sciatic nerve in rats and then stimulated the gastrocnemius and soleus muscles with electrical applications for twelve to twenty minutes daily. He found that stimulation retarded the loss in muscle excitability and relative dry weight, and that the best results were obtained when the stimulation was started immediately after denervation. He concluded that the electrical treatment has a training effect on denervated muscle, similar to its effect on normal muscle, the size of the fibers and their metabolic capacity are increased but the structure of the muscles is not markedly influenced. That electrical treatment fails to repair the damaged structure of denervated muscle explains the fact that denervated muscle improves only slightly in power following treatment, despite the marked arrest of atrophy as measured by the relative increase in weight and excitability. During muscular atrophy due to immobilization or denervation, changes occur in the physio-chemical state of the protein myosin. These changes can be retarded in denervation atrophy, and recovery can be accelerated after immobilization by electrical treatment, or by massage, consisting of five minutes of gentle petrissage twice daily.

## TECHNIQUE

For the maintenance of tone in skeletal muscles, motor nerves must be intact. The most satisfactory contraction is that produced by voluntary impulse. For this reason emphasis is placed on exercise in those conditions in which it is desired to hasten the restoration of function in disused muscles as after splinting of a fracture or after temporary paralysis. When, however, voluntary contraction cannot take place, contraction should be induced by electrical stimulation. For this purpose that type of current should be applied which will evoke a satisfactory contraction with the least discomfort. When reaction of degeneration is present, the muscles, if they respond at all, react best to the interrupted galvanic or the slow sinusoidal current. The interrupted galvanic current is relatively painful; the make and break of the current flow occurs abruptly. The slow sinusoidal current is characterized by its gradual rise and fall. It is therefore advised in the treatment of paralysis when one set of muscles shows reaction of degeneration and its antagonist shows normal response.

When the electrical reactions of muscles are normal, faradic and rapid sinusoidal currents will stimulate them to contract. To avoid muscle fatigue, it is necessary to allow for a sufficiently long period of rest between contractions. It has been stated that the period of rest should be as long as that of contraction. A gradual rhythmic onset and diminution of flow is desirable. The static wave current is able to cause vigorous muscular contractions with very little discomfort, but its use requires a special machine.

In flaccid paralysis, the initial number of contractions should be few, possibly four or five. The number may be gradually increased with the vigor of the contractions, keeping in mind the fact that paralyzed muscles fatigue easily. The response of fatigued muscles is sluggish and irregular. Treatments are applied daily, either to the entire body or locally. Local treatments are most commonly administered through the use of moist pads previously described. For treatment of muscles of the upper extremity, one pad can be placed on the upper back; the other, over the forearm. Similarly, for muscles of the lower extremity one pad can be placed on the lower back and the other in the region of the calf or another area along the thigh or leg. By means of this technique, groups of muscles can be made to contract. When paralyzed and healthy muscles are stimulated at the same time there is danger of overstretching the normal muscles. Therefore it is generally advisable to employ a small active electrode which will stimulate only single muscles or small groups of muscles. The "Schnee bath" (page 227) is sometimes used to induce movement of the muscles of the extremities en masse.



Ornstein and Licht have described a procedure for elevation of venous pressure in shock by faradic stimulation. A large belt electrode made of block tin, 6 inches wide and 50 inches long, is wrapped around the lower abdomen, the lower lumbar and gluteal regions, which have previously been covered with towels soaked in physiological salt solution. This electrode is connected to one pole of the faradic machine. The other pole is connected by means of a bifurcated cord to two electrodes made of the same metal, each 4 inches wide and 50 inches long, which are wrapped in legging fashion around saline soaked towels placed around the lower extremities. The treatment is continued for forty five minutes.

The technique used to cause contractions of individual muscles is the same as that described for electrodiagnosis (page 246). A longitudinal bipolar technique consists in placing two small electrodes on the muscle to be stimulated, and moving them about until the most vigorous contraction is elicited. As this technique is painful, it should not be used unless a single active electrode fails to elicit contraction.

Local treatments are administered daily or every other day. The duration of the initial session may be about ten minutes. Subsequently the time for the treatment is gradually lengthened to about twenty or thirty minutes. The character of the reaction should be the guide. Care must always be exercised to avoid muscle fatigue.

General treatments can be applied by means of the full length bath. The tub is constructed out of some non conducting material such as porcelain or wood. The water within it is usually warmed to a temperature of about 95° F. The current is introduced by means of plate electrodes usually placed at either end and covered so that the patient cannot touch them directly. It is necessary to take great care that the current employed is ground-free, otherwise the danger of a serious shock may exist. This type of treatment is most commonly applied in spas, particularly those abroad.

Conversive heating with the long wave diathermy current may be administered in conjunction with the interrupted galvanic or sinusoidal currents. To accomplish this a choke coil and a condenser must be used. The choke coil stops the high frequency current from interfering with the galvanic portion of the circuit, the condenser prevents the unidirectional current from entering into the high frequency portion of the circuit.

#### INDICATIONS

The therapeutic possibilities of the electric current in causing muscle movement depend on the nature of the pathological involvement. In an upper motor neuron lesion, for example, that occurring in hemiplegia, it is obvious

that the final outcome will depend on the degree of permanent damage to the brain tissue. So, too, lack of muscle motion due to myopathies will not be basically affected by electrical stimulation.

On the other hand, contractions produced electrically can be of substantial benefit in myositis, fibrositis, sprains and contusions, and in muscle atrophy due to prolonged immobilization. They may also be of value in restoring muscle tone in conditions such as cardiac disease and after parturition. They have been recommended to loosen adhesions, remove exudates, and as a method of teaching muscle re-education. In lesions of the lower motor neuron, electrical stimulation helps to maintain the muscle in a state permitting its contraction when the voluntary nerve impulse is able to get through. It is applied toward this end in lesions of the spinal cord such as poliomyelitis, infectious or traumatic myelitis, and peripheral nerve lesions. If the motor nerve pathway is permanently interrupted, electrical stimulation provides a poor substitute for normal nerve impulses.

#### CONTRAINDICATIONS

Injury may be caused by electrical stimulation if care is not exercised to prevent overstretching of paralyzed muscles due to activity of the opposing normal muscles, and also if muscular contractions are allowed to reach the point of fatigue. It should not be employed as a substitute for voluntary contractions except in special instances. In the early stages of trauma, such as in sprains, contractions may aggravate the condition.

#### STATIC CURRENT

The static current machine is seldom used today. It is large, costly, and difficult to keep in good working order, particularly in places where the humidity is high. In spite of these objections, it is a valuable apparatus. The current it generates is characterized by a very high voltage, low amperage, and very short duration. Various forms of application are possible (Fig. 161).

#### STATIC WAVE

The current most commonly used is the so-called static wave, which will produce vigorous muscular contractions painlessly. A moistened metal plate is applied over the muscles, and connected to the positively charged conductor. The negative side of the machine is grounded. A simple way to ascertain the polarity of the terminals is to apply one end of a long wooden rod to the metal ball on one side of the spark gap: on the positive side the spark will follow the wood as it is moved about on the brass ball; on the

negative, the spark is not affected. Before the static wave is applied, the spark gap should be closed, then gradually opened. The length to which it is opened determines the voltage of the current and the vigor with which

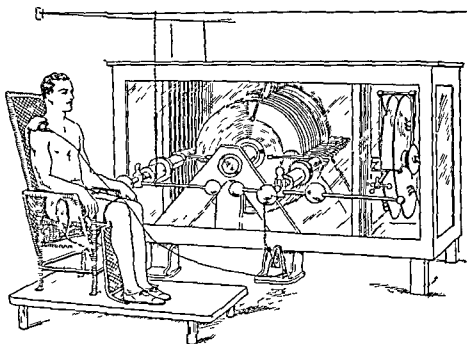

FIG 161 Static machine

contractions will occur. The frequency with which the sparks jump across the gap can be controlled by the rheostat that regulates the speed with which the glass plate revolves. Periods of interruption may also be provided by a metronome which is placed in series with the patient. The patient should be seated on an insulated wooden platform, in a wooden chair made with a minimum of metal. Treatments should last about fifteen to twenty minutes.

The static wave current is of value in the treatment of myositis, fibrositis, sprains, synovitis. The sudden and vigorous contractions which it produces are beneficial in conditions characterized by adhesions, for example, those in the neighborhood of the shoulder joints. The muscular relaxation it produces is of therapeutic assistance in the care of the conditions mentioned and also in chronic arthritis. By means of metal electrodes, it is used for vaginismus and rectal spasm. It has also been used for the treatment of enlarged, soft prostate.

#### STATIC SPARK

The static current can be applied in more concentrated fashion by means of the spark technique. The patient is seated or stands on the insulated plat-

form. The platform is connected to the positive terminal of the machine by a metal rod. The negative side is grounded. The prime conductors may be pulled wide apart or permitted to stay relatively close to each other so that sparks jump across the gap. In the so-called indirect technique, a brass ball electrode connected to a ground is brought close to the part to be treated. As the metal ball nears the skin surface, a spark jumps across. This causes a disagreeable stinging sensation, the severity of which depends on the size of the spark as well as on the sensitivity of the patient. A very vigorous contraction ensues if the spark is applied to a region covering muscle. It should not be applied to any other area. In the "direct" technique the ball electrode is connected directly to the negative pole.

As the static spark technique is painful, it should be used sparingly in the treatment of nervous patients. It is a valuable remedy in the acute type of myofascitis, known as "lumbago," and for the pain which occurs along the distribution of the sciatic nerve in sacro-iliac disease. In what has been termed sacro-iliac disease, it may give relief more quickly than does the static wave. The number and size of the sparks should be varied in accordance with the chronicity of the disease and the tolerance of the patient.

#### STATIC BRUSH DISCHARGE

The static brush discharge is another useful variation of the static current. The patient stands or sits on the insulated platform. He is connected to the negative pole by a metal rod which he holds in his hand. The spark gap is held wide apart so that no sparking occurs across it. The positive pole is grounded. The operator approaches the part to be treated with the tip of a deKraft blue pencil. This is a cylindrical fiber tube filled with asbestos shreds; the tip is conical and made of metal. With the current flowing and the metal tip held a few inches from the skin a bluish discharge traverses the space between the pencil and the skin surface of the patient. The sensation has been variously described by patients as that of a sand blast or a strong breeze. If the pencil is brought too close, a spark will pass between the skin and the tip, causing a painful sensation. The static brush discharge is of definite value in the treatment of traumatic swelling and in the early stages of Bell's palsy. In the latter condition the discharge is played over the trunk of the facial nerve at its emergence from the stylomastoid foramen and along its branches in the side of the face.

#### STATIC INDUCED CURRENT

Vigorous muscular contractions can be produced at one or more portions of the body by the static induced current. In the application of this current

the inner coatings of two Leyden jars are connected to the prime conductors. The outer coatings of the jars are connected by metal plates placed on the patient. A small distance between the balls of the spark gap is sufficient to cause a very vigorous contraction. This form of the current may be used when, because of high humidity, it is difficult to secure much energy from the machine. It can also be employed for those conditions in which the Bergoni apparatus is used, as in the treatment of obesity.

#### STATIC BATH

For psychic conditions, the technique called the static bath may be applied. The patient seated on the insulated platform is connected to the machine by a rod which extends from the platform to the positive pole. The negative pole is grounded. The gap is held wide apart. The patient becomes positively charged and his hair stands erect. This form of treatment is advocated for the care of neurasthenia. A modification, also used for psychic purposes, is that known as the crown breeze. The arrangement is essentially the same as in the application of the static brush. A crown shaped metal electrode is held suspended about one foot above the head of the patient by means of a floor stand made of some non insulating material like wood. The metal crown is connected to a ground.

#### REFERENCES

- ABRAMSON, H. Treatment of hay fever coseasonally by electrophoresis of active constituents of ragweed extract—Preliminary report *New York State J Med*, 39 1611, 1939.
- ABRAMSON, H. Comparison of treatment of severe asthma by electrophoresis of epinephrine with other methods *Arch Phys Therapy* 21 261-266, 1940.
- BOURGUIGNON, G. Localisation de l'excitation dans la méthode dite "monopolaire" chez l'homme *Rev neurol*, 27 553, 1914.
- CHOR, H., CLEVELAND, D., and DAVENPORT, H. A. Atrophy and regeneration of the gastrocnemius soleus muscles. Effects of physical therapy on monkeys following section and suture of the sciatic nerve *JAMA* 113 1029-1033, 1939.
- CHOR, H. Some problems in muscle disorders *Physiotherapy Rev* 16 35, 1936.
- CUMBERBATCH, E. P. Electrotherapy in general practice *Practitioner* 14 145-153, 1938.
- FISCHER, E. Effect of faradic and galvanic stimulation on course of atrophy in denervated skeletal muscles *Am J Physiol* 127 805-818, 1939.
- FISHER, E., and RAMSEY, V. W. Changes in muscle proteins during muscular atrophy *Arch Phys Therapy* 25 709, 1944.
- GRODINS, F. S., OSBORNE, S. L., JOHNSON, F. R., ARANA, S., and IVEY, A. C. Effect of appropriate electric stimulation on atrophy of denervated skeletal muscles in the rat *Am J Physiol* 142 222, 1944.

- HARPUDER, K. Electrophoretic therapy. *New York State J. Med.*, 38 : 176-179, 1938.
- HINES, H. M., THOMSON, J. D., and LAZERE, B. Physiologic basis for treatment of paralyzed muscle. *Arch. Phys. Therapy*, 24 : 69, 1943.
- LEWIS, G. M. Electrolysis in skin disorders. *Med. J. & Rec.*, 1931.
- MACKEE, G. M. The treatment of skin diseases by physical therapeutic methods. *J.A.M.A.*, 98 : 1646, 1932.
- MENNELL, J. B. *Physical Treatment by Movement, Manipulation and Massage*. Philadelphia, Blakiston, 1934.
- ORNSTEIN, O., LICHT, S., and HERMAN, M. Raising of venous pressure in surgical shock by faradic stimulation. *Arch. Phys. Therapy*, 21 : 329-335, 1940.
- SMART, M. *The Principles of Treatment of Muscles and Joints by Graduated Muscular Contractions*. London, Oxford University Press, 1933.
- SNOW, W. B., and KRAUS, H. Novocaine ion transfer for painful limitation of motion. *Mil. Surgeon*, 95 : 301, 1944.
- TURRELL, W. J. The physiologic and therapeutic action of interrupted currents of low frequency and of the constant current. In *Principles and Practice of Physical Therapy*. Hagerstown, Maryland, Prior, 1932, Vol. III, Chap. 9, 10.
- WEHRMACHER, W. H., THOMSON, J. D., and HINES, H. M. Effects of electrical stimulation on denervated skeletal muscle. *Arch. Phys. Med.*, 36 : 261, 1945.

## CHAPTER X

# ULTRAVIOLET RADIATION

### HELIO THERAPY (Fig 162)

**I**N ADDITION TO VISIBLE AND INFRA-RED RAYS, SOLAR radiation contains rays belonging to the ultraviolet portion of the spectrum. It is these rays which produce the erythematous reaction called sunburn, and which are responsible for some of the physiological changes necessary for the maintenance and restoration of health. Yet these rays form less than 1 per cent of the total solar radiation, according to Coblenz, who made determinations at noon on a clear day in the latitude of Washington, D. C. Under less favorable conditions, for instance, in more northern latitudes between 3 P.M. and 9 A.M. during the winter when the days are cloudy, or when there is much dust in the air, the total intensity of ultraviolet radiation becomes inadequate as a therapeutic medium.

The wavelengths of the ultraviolet rays reaching the earth's surface range from about 2900 to 3900 Angstrom units (the beginning of the visible spectrum). The sun's radiation produces much shorter wavelengths than these, but intervening substances in the atmosphere filter out all radiation under 2900 Angstrom units (Fig 163).

In some parts of the world the sun shines with sufficient constancy to be therapeutically useful during a large part of the year. In the Alps, Bernhard found that he could treat open wounds satisfactorily with heliotherapy, and Rollier observed good results with this method in cases of surgical tuberculosis. Saidman has devised an ingenious instrument for the concentration of solar radiation. It is designed to permit the use of this energy in regions where it is otherwise insufficient, and to make it more effective in places where it is already sufficient. Skyshine contributes a considerable percentage of ultraviolet, as solar radiation is diffused by the minute particles in the air. The shortest wavelengths in skyshine vary between 3150 and 3200 Angstrom units. According to Laurens, on a clear summer day the diffuse radiant energy from the sky is between 12.3 and 33.3 per cent of the total.

Reflection provides another important source of indirect ultraviolet radiation. The danger of "snow blindness" is generally recognized, and avoided by wearing tinted lenses. The percentages of radiation reflected have been

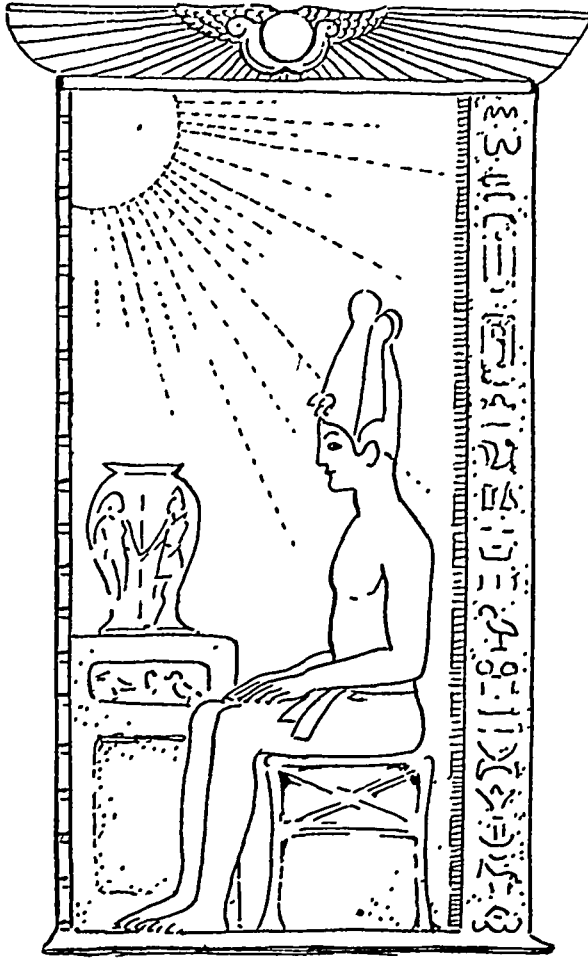

FIG. 162. Ra, the Egyptian sun god.

reported as follows: 89 per cent from ice and fresh snow; 64 per cent from old snow; 7 per cent from moist soil, and 6 per cent from green pastures.

In regions, where heliotherapy is used extensively for the care of such diseases as non-pulmonary tuberculosis, rheumatoid arthritis, and sinusitis, it is recognized that abundant natural ultraviolet radiation is only one factor in the therapeutic results obtained. Other contributory climatic factors are temperature, humidity, and motion of the air, as well as large quantities of visible and infra-red radiation.

In many regions within the temperate zone, there is usually sufficient sunshine to permit the therapeutic use of solar radiation during late spring,



summer, and early autumn. Its value is recognized in a general way when patients are transferred to a hospital roof, or advised to go to the country for sunshine and fresh air. Such medical advice would be more satisfactory

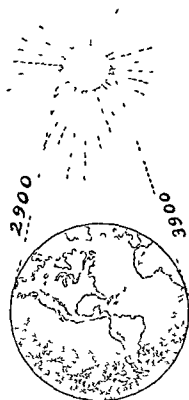

FIG. 163. The limits of solar ultraviolet radiation reaching the earth's surface indicated in Angstrom units.

if the ultraviolet dosages could be measured with some degree of exactness.

The Negro, protected by his pigmentation, can spend a large portion of the daylight hours in the sun with impunity. The white man with most of his body shielded by clothing cannot do likewise. Occasionally, on an early summer day he forgets this, and clad only in scant trunks, lies about on a beach for several hours. That evening, when his sunburned skin, headache, fever, and malaise remind him of this fact, he resolves to expose himself more gradually to the sun's rays in the following year. Observations made on a large group of persons receiving sun baths showed that heliotherapy even in the usual doses may have an injurious effect. The early effects were dilatation and increase in the number of capillaries, followed by pericapillary edema. The late effects included disturbances of the gastrointestinal tract, changes in the composition of the blood, increased sedimentation rate, and functional disturbances of the cardiovascular system.

Healthy adults appear able to tolerate exposure to sunlight over a considerable area of their bodies, if the exposure does not cause more than a slight erythema. The amount of solar radiation that will cause such a limited reaction varies with several factors: the intensity of the sun's rays, the age of the individual (the very young and very old do not tolerate solar radiation well), whether the skin is dark or fair, whether the person tans readily or not, and the like. These factors are considered in further detail in the discussion of artificial ultraviolet radiation (page 293).

The individual for whom ultraviolet radiation from the sun is prescribed is usually one whose status is not completely normal; he is either suffering from disease conditions which may be benefited by such exposure, or he may be convalescing from some disease. Under these circumstances, exposure should be more gradual than if he were in normal health. It is well to start with a period of about fifteen minutes and gradually increase this by about five minutes each day. The rate of increase should depend on the reaction: if he "stands it well," long periods can be prescribed. If his tolerance is low, he may suffer from headaches, elevated body temperature and pulse rate, nervousness, or irritability and restlessness. Such a reaction calls for diminution in exposure time or possibly complete cessation of the exposure.

According to Rollier's procedure, the patient is kept out of the sun for several days until he becomes gradually acclimatized; he is then exposed to the sun in carefully graded doses, as outlined in Figure 164. This indicated dosage is a general one; it is necessary to take into account variable factors such as the general condition of the patient, localization of the lesion, tolerance to sunlight and changes in atmospheric conditions such as temperature, air motion, position of the sun, and the state of the atmosphere. Dr. Rollier described his technique as follows:

"Under the average conditions assumed in the diagram, the feet are uncovered on the first day three times for five minutes, on the second day three times for ten minutes, and on the third day three times for fifteen minutes, and so on. On the second day, the legs are exposed at the same time as the feet, but only for five minutes; on the third day the thighs are similarly uncovered for five minutes, while the legs have ten minutes and the feet fifteen.

"On the fifth day, for example, the patient will have, at ten-minute intervals, three sunbaths of twenty-five minutes' duration, uncovering the feet first and then, at five-minute intervals and in the following order, the legs, thighs, abdomen, and thorax. In cases complicated with pulmonary tuberculosis even slower progress is necessary. Where there is any cardiac disease

or simply tachycardia, a white cloth should be placed over the cardiac region. The head and nape of the neck should always be protected by a white linen hat, which should, if possible, be lined with green gauze, as this is more

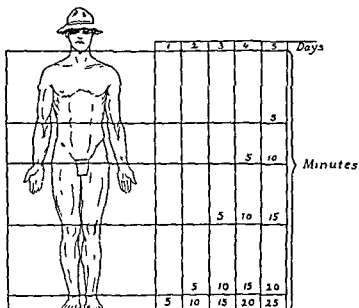

FIG 164 Rollier's scheme for heliotherapy dosage

restful to the eyes than white. Smoked, dark yellow, or black glasses should also be used to protect the eyes.

"If all goes well for ten days or so, the periods of insolation may be lengthened and reduced to two or three in number, by this time any idiosyncrasies of the patient will have been discovered and a fairly accurate estimate of his tolerance to sunlight formed, it will therefore be possible to hurry on the treatment with some patients while continuing cautiously with others. The duration of the sunbath must also depend on the rate at which pigmentation takes place, where there is early pigmentation rapid advance may be made, while with patients whose skin reddens rather than browns there is danger of erythema and caution is necessary. If for any reason the patient has had to interrupt treatment before he is properly pigmented a start must be made several stages behind the previous maximum.

'When once the skin is well pigmented all over the body there is no longer any danger of over exposure, and the patient may have several hours of sun-cure every day. Three hours a day is for the majority of people the most suitable amount of exposure to sunlight, indications to exceed this only exist in young persons whose bodies adapt themselves easily to their new surroundings and who pigment well. As a general rule, sunbaths should be

of shorter duration in summer than in winter, as in the former season the temperature of the air being itself comparatively high the additional heat of the sun is not so well tolerated."

In the treatment of tuberculous peritonitis, Rollier cautions that exposure of the abdomen should be begun only after exposure of the lower extremities for at least one hour does not cause any signs of intolerance. This is usually not until several weeks have elapsed. The duration of the first abdominal exposure should be only two to three minutes, and it should always be preceded by exposure of the lower extremities for at least one hour.

Rollier applies heliotherapy in tuberculosis of the bones and joints, peritoneum, and intestines. The prognosis is good in the purely ascitic form of peritonitis, although the plastic and fibrocaseous forms also react favorably. He believes that heliotherapy should be applied with great care in pulmonary tuberculosis, for overexposure may aggravate the condition. Rollier also treats non-tuberculous conditions such as arthritis and osteomyelitis with heliotherapy. He believes that the general and local effects produced in osteomyelitis are similar to those produced in rickets and tuberculosis. He considers that the stimulation of osteogenic activity induced by heliotherapy is an indication for its use in bony disorders such as osteochondritis, epiphysiolysis, osteomalacia; and also in dystrophic conditions of adolescents resulting from late rickets—tarsalgia, coxa vara, painful epiphysitis (Scheuermann's disease), scoliosis, and kyphosis. He states that in fractures, it should be used in conjunction with other physical dietetic and orthopedic procedures, to promote callus formation, accelerate resorption of extravasated blood and edema, and hasten the disappearance of other signs of interference with nutrition due to immobilization.

Bernhard, a pioneer in heliotherapy, in summarizing the results of his thirty-five years of experience stated that he had found the sun's rays of value in the treatment of wounds in which healing by first intention could not be expected; that is, wounds resulting from circulatory or trophic disorders, from burns, cold, acids, and roentgen rays, as well as infected wounds. He observed good results from the use of heliotherapy in the postoperative care of osteomyelitis, of fractures, and of rickets. In the management of surgical tuberculosis, heliotherapy yielded excellent results. He treated about 2500 cases (two thirds of them children) comprising tuberculous infections of the skin, tendon sheaths, synovial sacs, lymph nodes, bones, joints, genitourinary tract, serous membranes, and intestines. Of his first 1000 patients, 858 were cured, 120 were improved, 8 were unimproved, and 14 died. He

states that tuberculous lymphoma in all stages is favorably influenced by heliotherapy fibrous contraction and sclerosis of the tubercles is stimulated, caseous foci, if not too large, are encapsulated by connective tissue proliferation or becomes calcified, infected hilar and mesenteric lymph nodes are favorably influenced, tuberculous joints are restored to normal function Combined with orthopedic measures, heliotherapy causes healing of tuberculous bones The solar radiation can be administered in closed rooms if uviol or vita glass is used for the windows

Other workers both in Europe and in this country have achieved similar results in the treatment of surgical tuberculosis with solar radiation It appears to be the general opinion that heliotherapy is superior to ultraviolet radiation obtained from artificial sources in the treatment of tuberculous lesions

Although heliotherapy has proved to be a tremendous advance in the treatment of tuberculosis, it is well to bear in mind Mayer's words of caution He states that "to believe that sunlight or artificial sources of light will cure all forms of surgical tuberculosis, to be unduly optimistic about this treatment and to consider it a specific form of treatment, to use it without sound medical guidance and adequate equipment, and finally to employ it to the exclusion of rest and hygienic regimen, eliminating orthopedic measures or the occasional surgical intervention in bone and joint tuberculosis, is bound eventually to dishearten many sufferers and to bring discredit on an otherwise desirable method of treatment"

#### APPARATUS

The physics of the electromagnetic spectrum are referred to briefly in the section on phototherapy and infra red radiation (page 92 ff) Lamps producing ultraviolet radiation also give off energy in the visible and infra red portions of the spectrum The relative percentages of these three types of radiation as well as their total intensities vary with different instruments A good source of comparison is the sun Laurens states that at the surface of the earth, with the sun moderately high and a total intensity between 1 and 1.5 gram calories per square centimeter per minute (70,000 and 105,000 microwatts per square centimeter), the percentage of energy is distributed as follows ultraviolet, between 1 and 5 per cent, luminous, between 41 and 45 per cent, infra red, between 52 and 60 per cent When the sun is lower and the total intensity less, the ultraviolet is relatively decreased and the infra red increased At high altitudes, the total energy is increased, and with this the percentage of ultraviolet, while that of the infra red is diminished

## ARC LAMPS

Of the artificial sources of ultraviolet radiation, those which produce spectra most closely resembling the spectrum of the sun are the arc lamps

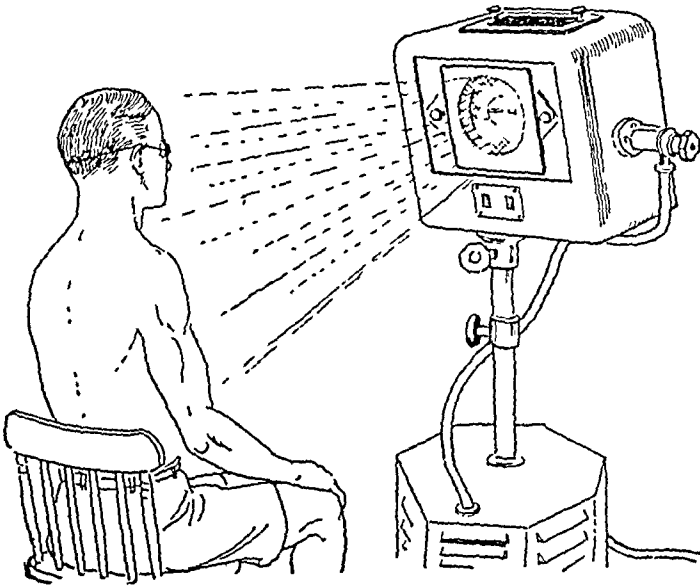

FIG. 165. Carbon arc lamp.

(Fig. 165). The type of metal between which the electric arc is struck determines the character of its spectrum. In Europe, use is made of iron and tungsten arc lamps. Because of the sputtering noise and the acrid fumes which these devices produce, the tendency in this country is to employ the flame type of carbon arc. The carbons are usually made hollow through the center and filled with a mixture of carbon and other metals. The electric current passing across the arc creates intense heat which volatilizes the carbon and the mixture in its core. The temperature of the positive electrode of the carbon arc is about  $6000^{\circ}$  F. The radiation comes mainly from the luminous vapor produced by volatilization and the crater of the positive electrode. The two varieties of cored carbons most commonly employed are those called "Sunshine" and "Therapeutic C," the latter producing the greater percentage of ultraviolet light. Laurens reports that from a flaming carbon arc, utilizing sunshine carbons and with a current of 25 amperes flowing across the arc, the energy emitted was 0.325 gram calories per square centimeter per minute at one meter, or 1 gram calorie at 57 centimeters, and 1.5 gram calories at 46.6 centimeters. The radiation was 6 per cent ultra-

violet, 50 per cent luminous, and 44 per cent infra red. With a Corex D filter the radiation more closely resembled solar radiation, with the shorter ultraviolet and longer infra red rays eliminated. The total intensity was also reduced. The spectral distribution was 5 per cent ultraviolet, 63 per cent luminous, and 32 per cent infra red. With the "Therapeutic C" carbons, the intensities were the same but the distribution was 9 per cent ultraviolet, 24 per cent luminous, and 67 per cent infra red.

An arc lamp may have a single or multiple burner. Office models on floor stands usually have one or two. For the radiation of many individuals at one time, as in an institution, larger lamps are used. These are customarily placed overhead, preferably suspended from the ceiling. Such units operate at about 60 amperes and 50 volts. The number of arcs employed is usually one, two, or four. With 'Therapeutic C' carbons, these solarium units can produce a first degree erythema in two minutes at a distance of eight feet, with "Sunshine" carbons, at the same distance, erythema is produced in ten minutes.

For effective office use, a carbon arc lamp should have an automatic adjusting mechanism so that the size of the gap is kept more or less constant as the carbons burn away. The amperage of the current across the gap should be at least 20, and more if possible. Inasmuch as most houses are wired to carry a load no greater than about 15 amperes, the installation of powerful carbon arc lamps requires special wiring with heavier cables and larger fuses. The limitation of the circuits in common use has restricted the size of carbon arc lamps manufactured for sale to the layman. To circumvent this difficulty, a lamp equipped with a transformer is made for professional use, the 13 amperes which it draws from the house line can be increased to 40 by the transformer. The diameter of the carbon used in a lamp bears a relationship to the current employed. For example, lamps of 25 to 30 amperes require a 12 mm carbon to secure an efficient output, with a current of from 8 to 10 amperes, the carbons should be from 6 to 8 mm in diameter.

The special advantages claimed for the arc lamp in comparison with the mercury vapor lamp are that it produces a continuous spectrum which more closely resembles that of the sun, it is of greater clinical value in the care of wounds, tuberculosis, high blood pressure, and when applied for general tonic purposes, the pigmentation following exposure to arc radiation is reddish brown, whereas that secured from mercury vapor lamps is a grayish brown.

## ARC LAMPS

Of the artificial sources of ultraviolet radiation, those which produce spectra most closely resembling the spectrum of the sun are the arc lamps

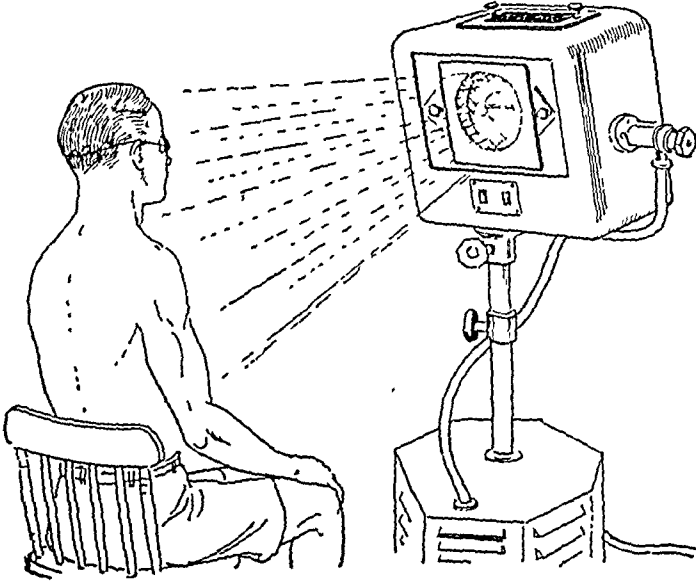

FIG. 165. Carbon arc lamp.

(Fig. 165). The type of metal between which the electric arc is struck determines the character of its spectrum. In Europe, use is made of iron and tungsten arc lamps. Because of the sputtering noise and the acrid fumes which these devices produce, the tendency in this country is to employ the flame type of carbon arc. The carbons are usually made hollow through the center and filled with a mixture of carbon and other metals. The electric current passing across the arc creates intense heat which volatilizes the carbon and the mixture in its core. The temperature of the positive electrode of the carbon arc is about  $6000^{\circ}$  F. The radiation comes mainly from the luminous vapor produced by volatilization and the crater of the positive electrode. The two varieties of cored carbons most commonly employed are those called "Sunshine" and "Therapeutic C," the latter producing the greater percentage of ultraviolet light. Laurens reports that from a flaming carbon arc, utilizing sunshine carbons and with a current of 25 amperes flowing across the arc, the energy emitted was 0.325 gram calories per square centimeter per minute at one meter, or  $\frac{1}{2}$  gram calorie at 57 centimeters, and 1.5 gram calories at 46.6 centimeters. The radiation was 6 per cent ultra-



violet, 50 per cent luminous, and 44 per cent infra red. With a Corex D filter the radiation more closely resembled solar radiation, with the shorter ultraviolet and longer infra red rays eliminated. The total intensity was also reduced. The spectral distribution was 5 per cent ultraviolet, 63 per cent luminous, and 32 per cent infra red. With the "Therapeutic C" carbons, the intensities were the same but the distribution was 9 per cent ultraviolet, 24 per cent luminous, and 67 per cent infra red.

An arc lamp may have a single or multiple burner. Office models on floor stands usually have one or two. For the radiation of many individuals at one time, as in an institution, larger lamps are used. These are customarily placed overhead, preferably suspended from the ceiling. Such units operate at about 60 amperes and 50 volts. The number of arcs employed is usually one, two, or four. With "Therapeutic C" carbons, these solaria units can produce a first degree erythema in two minutes at a distance of eight feet, with "Sunshine" carbons, at the same distance, erythema is produced in ten minutes.

For effective office use, a carbon arc lamp should have an automatic adjusting mechanism so that the size of the gap is kept more or less constant as the carbons burn away. The amperage of the current across the gap should be at least 20, and more if possible. Inasmuch as most houses are wired to carry a load no greater than about 15 amperes, the installation of powerful carbon arc lamps requires special wiring with heavier cables and larger fuses. The limitation of the circuits in common use has restricted the size of carbon arc lamps manufactured for sale to the layman. To circumvent this difficulty, a lamp equipped with a transformer is made for professional use, the 13 amperes which it draws from the house line can be increased to 40 by the transformer. The diameter of the carbon used in a lamp bears a relationship to the current employed. For example, lamps of 25 to 30 amperes require a 12 mm carbon to secure an efficient output, with a current of from 8 to 10 amperes, the carbons should be from 6 to 8 mm in diameter.

The special advantages claimed for the arc lamp in comparison with the mercury vapor lamp are that it produces a continuous spectrum which more closely resembles that of the sun, it is of greater clinical value in the care of wounds, tuberculosis, high blood pressure, and when applied for general tonic purposes, the pigmentation following exposure to arc radiation is reddish brown, whereas that secured from mercury vapor lamps is a grayish brown.

## ARC LAMPS

Of the artificial sources of ultraviolet radiation, those which produce spectra most closely resembling the spectrum of the sun are the arc lamps

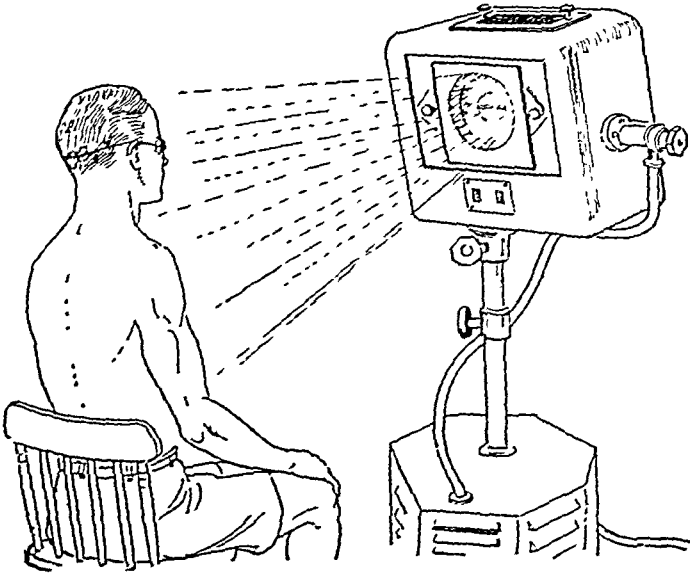

FIG. 165. Carbon arc lamp.

(Fig. 165). The type of metal between which the electric arc is struck determines the character of its spectrum. In Europe, use is made of iron and tungsten arc lamps. Because of the sputtering noise and the acrid fumes which these devices produce, the tendency in this country is to employ the flame type of carbon arc. The carbons are usually made hollow through the center and filled with a mixture of carbon and other metals. The electric current passing across the arc creates intense heat which volatilizes the carbon and the mixture in its core. The temperature of the positive electrode of the carbon arc is about  $6000^{\circ}$  F. The radiation comes mainly from the luminous vapor produced by volatilization and the crater of the positive electrode. The two varieties of cored carbons most commonly employed are those called "Sunshine" and "Therapeutic C," the latter producing the greater percentage of ultraviolet light. Laurens reports that from a flaming carbon arc, utilizing sunshine carbons and with a current of 25 amperes flowing across the arc, the energy emitted was 0.325 gram calories per square centimeter per minute at one meter, or 1 gram calorie at 57 centimeters, and 1.5 gram calories at 46.6 centimeters. The radiation was 6 per cent ultra-

violet, 50 per cent luminous, and 44 per cent infra red. With a Corex D filter the radiation more closely resembled solar radiation, with the shorter ultraviolet and longer infra red rays eliminated. The total intensity was also reduced. The spectral distribution was 5 per cent ultraviolet, 63 per cent luminous, and 32 per cent infra red. With the "Therapeutic C" carbons, the intensities were the same but the distribution was 9 per cent ultraviolet, 24 per cent luminous, and 67 per cent infra red.

An arc lamp may have a single or multiple burner. Office models on floor stands usually have one or two. For the radiation of many individuals at one time, as in an institution, larger lamps are used. These are customarily placed overhead, preferably suspended from the ceiling. Such units operate at about 60 amperes and 50 volts. The number of arcs employed is usually one, two, or four. With "Therapeutic C" carbons, these solaria units can produce a first degree erythema in two minutes at a distance of eight feet, with "Sunshine" carbons, at the same distance, erythema is produced in ten minutes.

For effective office use, a carbon arc lamp should have an automatic adjusting mechanism so that the size of the gap is kept more or less constant as the carbons burn away. The amperage of the current across the gap should be at least 20, and more if possible. Inasmuch as most houses are wired to carry a load no greater than about 15 amperes, the installation of powerful carbon arc lamps requires special wiring with heavier cables and larger fuses. The limitation of the circuits in common use has restricted the size of carbon arc lamps manufactured for sale to the layman. To circumvent this difficulty, a lamp equipped with a transformer is made for professional use, the 13 amperes which it draws from the house line can be increased to 40 by the transformer. The diameter of the carbon used in a lamp bears a relationship to the current employed. For example, lamps of 25 to 30 amperes require a 12 mm carbon to secure an efficient output, with a current of from 8 to 10 amperes, the carbons should be from 6 to 8 mm in diameter.

The special advantages claimed for the arc lamp in comparison with the mercury vapor lamp are that it produces a continuous spectrum which more closely resembles that of the sun, it is of greater clinical value in the care of wounds, tuberculosis, high blood pressure, and when applied for general tonic purposes, the pigmentation following exposure to arc radiation is reddish brown, whereas that secured from mercury vapor lamps is a grayish brown.

The disadvantages of the arc lamp, include the necessity for changing carbons as they burn away. This is considered a nuisance and an extra expense, and together with the greater amount of current consumed makes the maintenance of this apparatus more costly than that of the mercury vapor lamp. Furthermore, ashes are produced and fumes are given off during the operation of carbon arc lamps, and therefore special arrangements for ventilation must be made if very large lamps are used. However, in actual practice, these disadvantages are not great, and the carbon arc lamp has proved to be a serviceable apparatus. The small lamp commonly sold for home use may be effective if used within its limitations. Like all other forms of apparatus producing ultraviolet radiation, these small lamps should not be used by a layman except with the special advice and direction of a physician. Unquestionably self-treatment has resulted in much harm attributable to overdosage and to ignorance of contraindications to ultraviolet radiation. A layman who desires to administer ultraviolet radiation to himself or to members of his family should include the cost of an occasional visit to his doctor in the expense of running his machine.

#### MERCURY VAPOR QUARTZ LAMPS

The ultraviolet lamps generally used for professional purposes are those employing mercury electrically vaporized in an air-free tube. These are of two types: the so-called "hot quartz" and "cold quartz." Quartz is used for the mercury container because it withstands the high temperatures which these burners develop, and because it is the most convenient substance which is transparent to the ultraviolet spectrum. When new, the quartz permits the passage of radiation of wavelengths as short as  $1849 \text{ \AA}$ ; with use, it grows increasingly opaque to these very short wavelengths. Therefore the erythema-producing power of quartz burners should be tested at intervals. It has been stated that such burners can be used for more than 3000 hours and still give good service, though after 1000 hours the intensity of the radiation has diminished by one half to two thirds of its original value.

#### HOT QUARTZ LAMPS

In the hot quartz lamp, tilting of the burner breaks the layer of mercury extending between the electrodes. The heat developed by the current as it extends across the gap thus produced, vaporizes the mercury, permitting the current to continue to flow across the tube. In about ten minutes or less the current flow becomes stabilized, and the lamp is then ready for use. The incandescence of the mercury vapor produces the radiation. The quartz

burner may be cooled by air or by means of circulating cold water. This latter system of cooling is employed in lamps that are applied close to the body's surface, such as the Kromayer Quartz rods attached to the lamps permit the direct transmission of radiation to wound surfaces and into sinuses. The air-cooled burners are housed in reflectors, thereby increasing the radiation available for clinical purposes. For greater efficiency the reflecting surfaces as well as the burner must be kept clean by frequent wiping with cotton moistened in alcohol. The spectrum of the hot quartz mercury vapor lamp contains 28 per cent ultraviolet, 20 per cent luminous, and 52 per cent infra red radiation. This is a much larger percentage of ultraviolet than exists in the solar spectrum. The radiation includes wavelengths shorter than those reaching the earth's surface from the sun. The spectrogram shows the following series of bright lines superimposed on a faint continuous spectrum: 2537, 2660, 2804, 2967, 3024, 3132, 3342, and 3663 Angstroms (Fig 169).

#### "COLD QUARTZ" LAMPS

In the cold quartz mercury vapor lamp, the electric current is induced to pass across the tube by gases, such as neon or argon, which are contained within the tube. Sufficient heat is developed to vaporize the small pellet of mercury in the tubes. The lamp remains comparatively cold. The amount of electricity which it consumes is small. It is characterized by its low vapor pressure, low amperage, and high voltage. About 95 per cent of its ultraviolet radiation is at 2537 A°. It lights without tilting and its radiation reaches a maximum in about one minute. The tube can be coiled to form a flat spiral which, when backed by a reflector, permits radiation of a large surface. To irradiate the interior of wounds or body orifices the lamp can be shaped into a straight or curved short tube (Figs 166, 167).

Because of their bactericidal potency, and their ability to evoke a superficial reaction without causing marked pigmentation, the short wavelengths produced by this lamp make it particularly suitable for dermatological conditions. However, according to Coblenz, it is questionable whether rays of such short wavelengths should be used in general ultraviolet therapy. The Council on Physical Therapy of the American Medical Association does not accept for home use lamps that emit an appreciable amount of ultraviolet radiation of wavelengths shorter than 2800 A° unless they are to be used under the direction of a physician. There is still much discussion of the vitamin D stimulating value of cold quartz as compared with hot quartz burners.

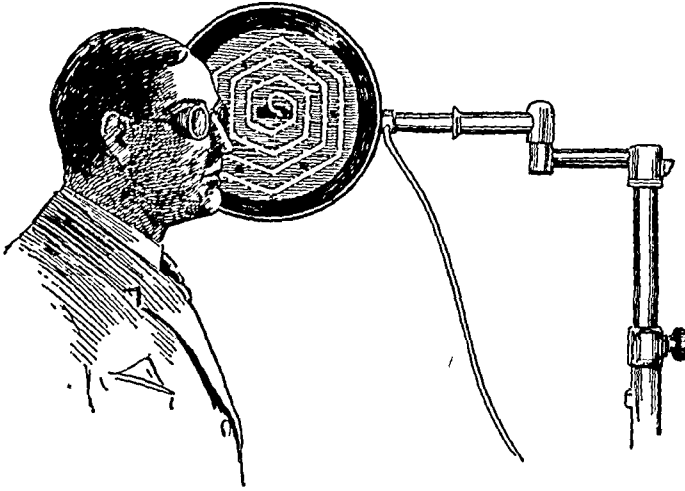

FIG. 166. Cold quartz applicator for skin surface irradiation.

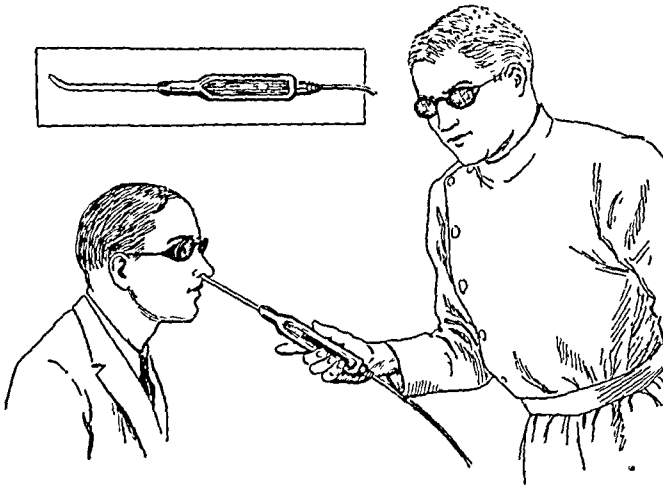

FIG 167. Cold quartz apparatus for orificial irradiation

Coblentz rates the antirachitic efficiency of ultraviolet radiation from various sources as follows

TABLE I  
ANTIRACHITIC EFFICIENCY OF ULTRAVIOLET  
RADIATION FROM VARIOUS SOURCES

U V SOURCE	ANTIRACHITIC/ERYTHEMA RATIO
Carbon Arc Therapeutic C	1 38
Mercury Vapor	
Low voltage hot quartz	1 14
Low voltage Corex D	1 14
High voltage, cold quartz low pressure	1 12
Sunlight midlatitude sea level midsummer mid-day	0 95

#### MERCURY VAPOR INDUCTION LAMPS

For body radiation these lamps, spherical in shape, are made of quartz or Corex D glass and contain a small pellet of mercury in a vacuum. Vaporization of the mercury is accomplished by a high frequency current which passes through a helix or coil surrounding the lamp. The lamp is designed for use in conjunction with diathermy apparatus. Its radiation characteristics are essentially the same as those of hot mercury burners. Modifications of the bulb permit its insertion into body cavities (Fig 168)

#### MERCURY VAPOR TUNGSTEN FILAMENT LAMPS

These lamps were developed for home use, but, like other ultraviolet apparatus, they should not be used without the advice of a physician. They consist essentially of electric light bulbs which are made of special glass to permit the passage of radiation whose wavelengths are not shorter than  $2800 \text{ \AA}$ , and contain a drop of mercury in a vacuum. They require special transformers connected to an alternating current source. When turned on, the heat developed in the tungsten filament vaporizes the mercury, which becomes incandescent and so produces ultraviolet radiation. These lamps are made in two forms. The S1 is said to give the same ultraviolet effectiveness as mid day summer sunlight at a distance of 30 inches, while the S2 has the same effect at a distance of 24 inches. Within ten to fifteen minutes, the average person will develop a mild sunburn.

Many other varieties of lamps producing ultraviolet radiation are available. In general, their essential characteristics are like those of the apparatus described. In order to guide the physician and to protect the layman, the

Council on Physical Therapy of the American Medical Association lists the lamps it considers acceptable, on the basis of their erythema-producing ability. Too intense a source of light may produce "burns"; too weak a source is

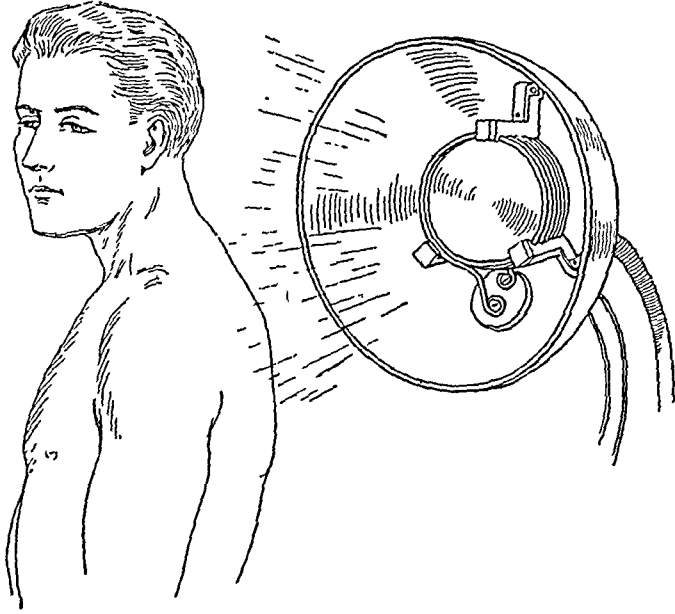

FIG. 168. Mercury vapor induction lamp.

ineffective. Also, the antirachitic value and erythemogenic properties are more or less related to the length of the waves. The Council's specifications of minimum intensity are determined at a distance of 24 inches from the front edge of the reflector, the distance at which danger of burns from infra-red radiation is excluded. The intensity must be great enough to produce a minimum perceptible erythema (which disappears in less than twenty-four hours) in not more than fifteen minutes for therapeutic lamps and in sixty minutes for sun lamps.

The Council has adopted 10 microwatts per square centimeter of homogeneous radiation of wavelength 2967 Angstrom units as the erythema unit of dosage intensity. Coblenz states that this standard was adopted for two reasons: "The intensity and the erythematogenic action of the emission line of mercury at 2967  $\text{A}^\circ$  is easily evaluated in absolute units and the erythema action as well as the radiometric output of the heterogeneous ultraviolet radiation from various sources is readily correlated with this emission line as a standard." From his experiments, he concludes: "It appears that a fifteen minute exposure to a flux density of 20 microwatts per square centimeter (or a total of 180,000 ergs) of homogeneous radiation of wavelength 2967  $\text{A}^\circ$  does not produce an erythema on the average untanned skin, though it may



be somewhat too intense for a blonde skin" Saidman has suggested adoption of the "Finsen unit" as a standard. In this unit each square centimeter of surface receives 6000 ergs of energy at wavelengths of  $2967 \text{ \AA}$ , at a distance of one meter in one minute.

#### TRANSMISSION OF ULTRAVIOLET RADIATION

Substances differ in their degree of transparency to radiation. Ordinary window glass is relatively opaque to rays in the ultraviolet region of the spectrum, although transparent to visible rays. Quartz and Corex D are good transmitters of ultraviolet radiation. Wood's glass, which contains nickel oxide, permits the passage of some ultraviolet rays but not the visible ones. This quality makes it an excellent filter. When attached to a source of ultraviolet radiation, it facilitates the observation of fluorescence because the examining chamber remains dark. Special types of glass which permit the ultraviolet component of the sun's rays to pass into a room have been developed to replace the usual window glass. They have not proved practical for general use because they are expensive, require constant cleaning to remove interfering dust, and permit only a relatively small percentage of the sun's rays to pass through. For special purposes, as in solaria, their use is warranted if their limitations are understood.

#### PHYSIOLOGY

Systemic effects of ultraviolet radiation vary with the extent, intensity, and duration of exposure. Severe toxic reactions develop from overdosages. Sunburn of a major portion of the body surface, for example, is a serious accident. It is marked by extreme tenderness and itching of the skin, rise of body temperature which may last until the cutaneous inflammation subsides and desquamation begins—a matter of several days, and systemic symptoms related to the pharmacodynamic action of histamine, which resembles those occurring in anaphylactic, allergic, and traumatic shock. These effects are manifested in general dilatation of the capillaries and extravasation of plasma, which causes diminution in the blood volume. The resulting cardiac and respiratory difficulties may lead to death.

Therapeutic dosages of ultraviolet radiation produce physiological changes which have been often described. The tissues of the eye are particularly sensitive to ultraviolet radiation. The sensitiveness of the cornea is responsible for the production of photo ophthalmia, which occurs from six to eight hours after exposure, blurred vision, pain, and headache may endure for a period of weeks, with subsequent sensitivity to further radiation.

## BLOOD CHANGES

The blood changes produced by ultraviolet radiation are: increased number of red and white cells and platelets, lowered blood sugar, increased sugar tolerance, increased blood calcium, relative lymphocytosis and eosinophilia. Laurens states that while ultraviolet radiation may increase the number of red blood cells in secondary anemia, it is not as effective as dietetic and drug treatment. He also states that there is no positive proof that ultraviolet radiation increases the resistance to general infection, although sunlight has a general tonic action.

Ultraviolet radiation from carbon arcs causes a temporary increase in cardiac output and a decrease in both systolic and diastolic blood pressures. This may be the result of the vasodilatation produced by the radiation and the consequent increase in the superficial vascular bed, or it may be due to chemical changes. Continued application of the rays, however, has not a long lasting influence on hypertension. Ultraviolet radiation of a solution of histidine results in the formation of a substance which reduces blood pressure. Ellinger thought this substance was histamine but Szendio subsequently concluded that it is imidoazoleacetaldehyde.

## METABOLIC CHANGES (Fig. 169)

Although the penetration through the skin by ultraviolet radiation is slight (about 0.1 mm.) vitamin D is formed from the activated provitamins lying within the skin. The ergosterol contained within the sterols and lipoids of the cells of the skin, hair follicles, sebaceous and sweat glands, changes into vitamin D. This change is produced most markedly by wavelengths between 2530 and 5100  $\text{A}^\circ$ , more particularly by those at about 2975  $\text{A}^\circ$ . With sunlight, the shortest wavelengths, those between 2900 and 3000  $\text{A}^\circ$ , are the most effective. Unfortunately these are absent during the winter in northern latitudes; and may also be prevented from reaching the earth's surface by soot and dust in the atmosphere. Following ultraviolet radiation the calcium and phosphorus content of the blood serum is increased, due to increased absorption from the intestines of the calcium and phosphate in food. This fact is of importance in prevention and treatment of rickets and tetany as well as in development and care of the teeth. The manner in which lime salts are deposited at the epiphyses of the long bones is still a matter of discussion. Robinson believes that it may be due to the presence of an enzyme-phosphate; a high concentration of blood phosphate favors such deposition.

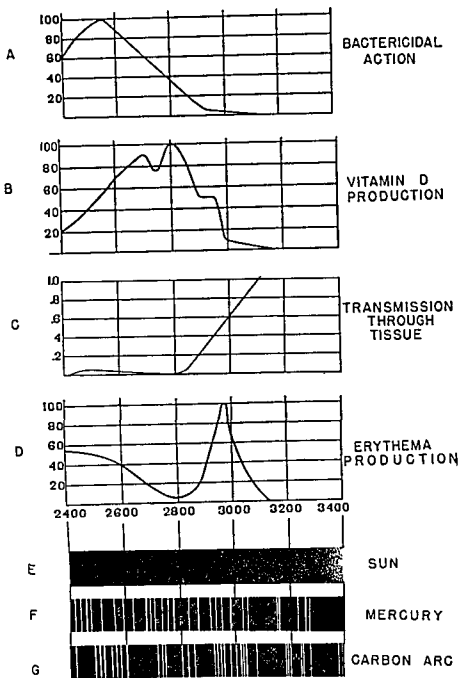

FIG. 169 Biological effects of ultraviolet radiation between 2400 and 3400 A Spectral distribution of ultraviolet radiation from the sun hot quartz mercury arc and carbon arc within the same limits

A Bactericidal action on *B. coli* indicating relative effectiveness and equal light intensity (Ehrsmann and Noethling *Zeitschrift für Hygiene und Infektionskrankheiten* 132 597, 1932)

B Vitamin D activation of ergosterol indicated in relative effectiveness of equal light intensity (Wijk and Reering *Strahlentherapie* 40 734 1931)

C Transmission of ultraviolet radiation through 1 mm of living human tissue indicating the percentage of transmission of incident ultraviolet radiation (Anderson and Fraser *British Journal Physical Medicine* November 1931)

D Erythema production showing relative effectiveness of equal light intensity (Coblentz Star and Hogue *Journal of Research Bureau of Standards* 8 554 1932)

E Ultraviolet spectrum of sun

F Ultraviolet spectrum of mercury quartz

G Carbon arc ultraviolet spectrum

The ability of ultraviolet radiation to activate sterols and so form vitamin D is utilized in the preparation of food products. Milk can be rendered antirachitic by ultraviolet radiation. Moreover its antirachitic factor may be increased by irradiating the lactating animal producing it. Because milk is rich in calcium and phosphorus, the Council on Foods of the American Medical Association considers that of all the common foods, it is the most suitable to serve as a carrier of vitamin D.

The pharmacodynamic action of vitamin D on the blood content and tissue utilization of calcium and phosphorus, is closely associated with the action of parahormone and of thyroxin. When there is a deficiency of vitamin D in the blood, calcium and phosphorus do not seem to be absorbed from the intestinal canal—even though they may be present in the diet—and the parathyroid glands attempt to make up the deficiency. Just what it is which thus stimulates the parathyroid activity is not clear. At any rate the parahormone is secreted in greater amounts (the parathyroids may become hypertrophied by their activity). As parahormone releases calcium and phosphorus from their stations in the tissues, particularly the bones, the bones and teeth suffer at the expense of the blood, and rickets and dental caries appear in growing children. Parahormone also hastens the excretion of calcium and phosphorus through the intestines and kidneys so that the loss at times is greater than the amount ingested in the diet. When blood calcium begins to fail, tetany may occur. The sequelae of vitamin D deficiency are: first, rickets, then spasmophilia, and then tetany.

The action of vitamin D and of the parathyroid gland is not the same. In the presence of calcium deficiency, parathyroid extract may relieve tetany in rachitic infants, but it does not improve the condition of inadequate calcium deposit in their bones. Vitamin D, on the other hand, while assisting the calcification of the metaphyses may, at the same time, cause a state of temporary hypocalcemia and tetany. Through its effect on calcium content, vitamin D improves the clotting time of the blood, reduces capillary fragility, lessens the permeability of cell membranes, and reduces muscular irritability.

While *overdosage of vitamin D* may result from excess oral medication, it does not occur from overexposure to photochemical radiation. Even the natives of the tropics, who live nearly naked and are at times exposed to the most powerful chemical effects of sun rays, do not develop hypervitaminosis. In spite of its efficiency in vitamin D production, radiation is ineffective in the presence of dietary deficiency of calcium and phosphorus.

Calcium and potassium are physiological antagonists. Ultraviolet radiation indirectly increases blood calcium through the creation of vitamin D, and decreases potassium through its production of histamine. Epinephrine, which

is a physiological antagonist of histamine, is produced as a result of stimulation of the adrenals by histamine, therefore the effects of histamine are transient unless chemical radiation is repeated until the general clinical picture is satisfactory

Other metabolic changes which have been described include increase in the endogenous nitrogen metabolism and in the fat content of the blood (cholesterol increase), and increased excretion of uric acid (The latter change indicates the advantage of ultraviolet radiation in the treatment of gout) Laurens describes a temporary diminution in the blood sugar of some persons suffering from diabetes, which he explains as probably due to increased excretion of insulin In normal persons, however, the blood sugar level is not influenced Pincussen likewise noted the insulin like action of ultraviolet radiation He found that the blood sugar level was lowered, while the glycogen content of the liver and muscles increased and the lactic acid decreased, and that in diabetics the glucose and acetone bodies in the urine were diminished

#### ERYTHEMA PRODUCTION

Following exposure of the skin of normal white persons to effective ultraviolet radiation, there occurs a latent period of about four hours during which there is no gross evidence of any reaction At the end of this time a skin erythema appears, gradually increasing until a maximum is reached in from about twenty four to forty eight hours, then gradually receding during the next two or three days If the intensity of the radiation is insufficient, no reddening of the skin is produced, and the dose is referred to as "sub-erythematous" If the intensity is great, edema and vesiculation may follow the erythema Not all sections of the ultraviolet spectrum are equally potent in the creation of erythema The most effective wavelength is at  $2967 \text{ \AA}$  Wavelengths longer than this diminish in their erythema producing power up to  $3150 \text{ \AA}$  at which point the reaction is lost Shorter wavelengths become increasingly less effective until they reach  $2600 \text{ \AA}$  Then, the erythema-producing ability again increases attaining a second though lower maximum between  $2500$  and  $2450 \text{ \AA}$  (Fig 169)

Inasmuch as radiation is a physical phenomenon which produces chemical and biological changes in the animal organism, the reaction which it evokes will vary with these factors Methods are available for the exact measurement of the intensity and wavelength of the radiation The chemical and biological responses cannot be accurately gauged They vary with each irradiated person Blondes are from 40 to 170 per cent more sensitive than brunettes, men 20 per cent more sensitive than women Infants and old

people are said to be more sensitive than others. Sensitivity increases at the menstrual period and between the second and seventh months of pregnancy. It is also greater with increased thyroid activity, elevation of blood pressure, and in active tuberculosis.

#### PIGMENT FORMATION

Repeated exposure to ultraviolet radiation results in tanning, due mainly to the deposit of melanin in the basal layer of the skin. Melanin is a pigment which is normally present in nearly all persons. It occurs in larger quantities in racially pigmented skin; albinos, red blondes, and infants do not appear able to produce it. Melanin is produced by the reaction of an oxidase of the skin plasma upon a colorless proferment which, in turn, is derived from tyrosine (the DOPA reaction). In white persons the tanning produced by the sun's rays or by artificial ultraviolet sources gradually fades. While a single exposure can also cause tanning, the degree of tanning so produced is not proportional to the intensity of a sunburn. Saidman found that the maximum degree of tanning follows an exposure, twice the intensity of the threshold dose that produces sunburn.

Following the production of pigment there is an increased tolerance to photochemical radiation. According to Saidman, this tolerance cannot be attributable to melanin, because the degree of tolerance is not co-equal with the degree of pigmentation. Rollier and others believe that the degree of pigmentation runs parallel with the therapeutic response.

#### FLUORESCENCE

When the human body is exposed to ultraviolet radiation in the dark, it will be seen to fluoresce in various tints and colors which are distinctive for such tissues as the skin, conjunctiva, hair, crystalline lens, teeth, and nails. This reaction may offer an explanation for some of the effects of radiation.

Pathological as well as normal tissues fluoresce in characteristic colors. This can be observed microscopically as well as grossly. Subcutaneous fat emits a clear yellow fluorescence. Tendons fluoresce white. Fluorescence has been used diagnostically to differentiate malignant from non-malignant tissue. Bacteria and viruses can be identified by their fluorescence. Fluorescence is of value in the diagnosis of some skin lesions. Pityriasis versicolor, for example, fluoresces a golden yellow, while psoriasis shows a silvery color. The fluorescence of ringworm is greenish. Many organic and inorganic substances fluoresce when exposed to ultraviolet light. Quinine sulphate gives a bluish color; uranium salts a yellow light.

An objective method for determination of the velocity of blood flow is based on the fluorescing response of the conjunctiva to ultraviolet radiation. Fluorescein is injected into the antecubital vein, and the conjunctiva is then exposed to radiation from a source covered with a Wood's filter. The time elapsing between the injection of the fluorescein and the appearance of fluorescence in the conjunctiva is considered the circulation time.

For the detection of fluorescence it is necessary to exclude visible rays. This may be accomplished by means of a darkroom or box, or a hood under which the object studied is placed. The ultraviolet source is covered with a filter such as the Corning glass filter No. 586 (sodium barium silicate glass containing nickel oxide), which transmits the region of the spectrum lying between 3500 and 4000 Å°.

#### PHOTOSENSITIVITY

Certain white skinned individuals react to very slight and brief intensities of ultraviolet radiation. This condition has been called photo allergy. The urticaria, itching, and systemic symptoms that characterize photo allergy subside on removal of the offending rays. Some of the manifestations, viz., vernal conjunctivitis and hydroa estivale, have been directly connected with the fluorescent substance hematoporphyrin. Since porphyrinuria appears after exposure to radiation and disappears on cessation of the exposure, it is possible that the porphyrines are a result rather than a cause of skin sensitization. Duke reported cases of hay fever, asthma, angioneurotic edema (Quincke's edema), and eczema, attributable to photo allergy. Skin diseases which showed increased sensitivity to ultraviolet radiation include acute eczema, seborrheic eczema, extensive pyoderma, urticaria, lichen ruber, and dermatitis herpetiformis. In one group of cases of psoriasis, the patients were hypersensitive, while in another, they were hyposensitive, those patients who showed normal or diminished sensitivity improved with the radiation. Xeroderma pigmentosum, Hutchinson's prurigo, lupus erythematosus discoides, keratosis, and epitheliomata are said to be due directly to photochemical effects in light sensitive skins. In Australia, Paul observed many cases of xeroderma pigmentosum, rodent ulcer, and epithelioma which he attributes to exposure to the intense sunlight of that country. The colored races are protected by their melanin pigment. He states that tropical skin (also known as farmer's skin and sailor's skin) has the same characteristics as dermatitis solaris chronica—freckle like spots, telangiectasis, white sclerotic areas, and keratosis, which may develop into epithelioma with continued exposure.

In a series of albino rats, which they subjected to twenty hours of ultraviolet radiation daily for one year (Roffo's procedure), Beard and his co-workers were able to produce sarcomas and carcinomas of the eyes, ears, and heads in 40 per cent. Cataracts appeared on the eyes after two months' radiation. They concluded that "because of the different behavior of rats and men toward sunlight and the massive doses of radiant energy necessary to produce the cancerous changes, no conclusions should be drawn regarding the carcinogenic effect of sunlight and ultraviolet light upon human beings."

#### DIETETIC HYPERPHOTOSENSITIVITY

Stockmen and veterinarians are well acquainted with the photosensitizing effects on white and piebald animals of buckwheat, which contains fluorphyll (a red photodynamic substance); of clover, maize, and sudan grass which contains flavin; and of red mangel (turnip), which contains the two yellow pigments, carotin and xanthopyll. When these foods are eaten they produce such intense photosensitivity that unless the animals are promptly removed to a dark barn, they die. Dark-skinned animals and those with dark-colored pelts are not at all affected. The condition is known as fagopyrism.

#### PHARMACEUTIC PHOTOSENSITIZATION

There are many substances, otherwise entirely innocuous and without pharmacodynamic action, which, when taken into the body, exert an intense sensitizing effect on skin exposed to photochemical rays. These substances become photodynamic through absorption of the rays, and emit, but only during the exposure, very active secondary radiation, which may be visible as fluorescence or be in the invisible ultraviolet. In this category are such dyes as eosin, fluorescin, rose bengal; the acridin group, such as benzo-flavine; the phosphines and gonacrin; and also methylene blue. There are some drugs which, aside from their usual pharmacodynamic action, become sensitizers; these are: anthraquinone, chrysophanic acid, xanthine, some arsenicals, barbiturates, gold, silver, the alkaloids (quinine, hydrastine), cyanine, naphthol, sulfonal, sulfanilamide, and tryptoflavine. Rashes have developed in persons taking sulfanilamide when localized areas of their skin were exposed to sunlight and to ultraviolet lamps. Clear watery solutions of sulfanilamide when exposed to ultraviolet radiation turn to the typical violaceous color.

I have not hesitated to give massive doses of ultraviolet radiation in cases



of erysipelas which had been treated unsuccessfully with large quantities of sulfanilamide. On the contrary, I have felt that the photosensitizing influence of the drug would enhance the action of the radiation in the involved local area. Jausion has argued similarly. He has suggested that if a sufficient quantity of ultraviolet radiation is not available, sensitizers can be used—gonacrin (diaminoacridine chlormethylate), diaminoacridine methane sulfonate, and eosin for the shorter wavelengths, and methylene blue and triphenylmethane violet (Hoffman) for red and infra red waves. These dyestuffs, or mixtures of them, may be given orally, rectally, or intravenously. Among the indications for photodynamotherapy which he mentions are falling hair, alopecia, tuberculosis of the skin, and surgical tuberculosis.

Many substances, when merely rubbed into the skin, will sensitize it to photochemical rays, for example, acridine, anthracene, anthraquinone (which can even produce cancer), vaseline, eau de cologne, oil of bergamot, oil of lavender, oil of cedar, chlorophyll, and certain red dyes used in lipsticks and clothing. It is also a question whether some of the so-called drug rashes and eruptions should not be classed among the reactions to photosensitivity.

Photosensitivity is counteracted by removing the person from the photochemical radiation, either into a darkened room or one lighted artificially or with red glass windowpanes. The action ceases very promptly. Jausion found that resorcin or pyrocatechin given in capsules nullifies the sensitizing action both in the skin and systemically. Elder stated that photosensitivity could be diminished by administering 10 grains of iron and ammonium citrate three times a day with meals. Any of the pigments used to prevent sunburn, or alum, tannic acid, or the naphthole (a and b) applied in an oily base will nullify photosensitivity. The presence in the skin of highly colored pigments such as melanin and the chromolipoids also serve as protective influences.

#### GERMICIDAL EFFECTS

It is possible to kill or to attenuate bacteria by means of ultraviolet radiation. Exceptions are organisms like the sulphur bacteria which grow in sunlight. The most effective wavelengths for bactericidal purposes are those shorter than  $2900 \text{ \AA}$ . *B. diphtheriae*, *B. coli*, staphylococcus, and *Vibrio cholerae* are killed with increasing effectiveness in the order mentioned (Fig. 169).

Radiation at the line  $2655 \text{ \AA}$  was found to exert the greatest lethal influence, followed in order by the lines  $2536$ ,  $2804$ ,  $2482$ , and  $2700 \text{ \AA}$ . When ex-

posed to sunlight, tubercle bacilli are killed within two to five hours. Addition of fluorescent substances to culture media intensifies the lethal effect of exposure to the radiation. Protozoa can be killed rapidly, particularly by

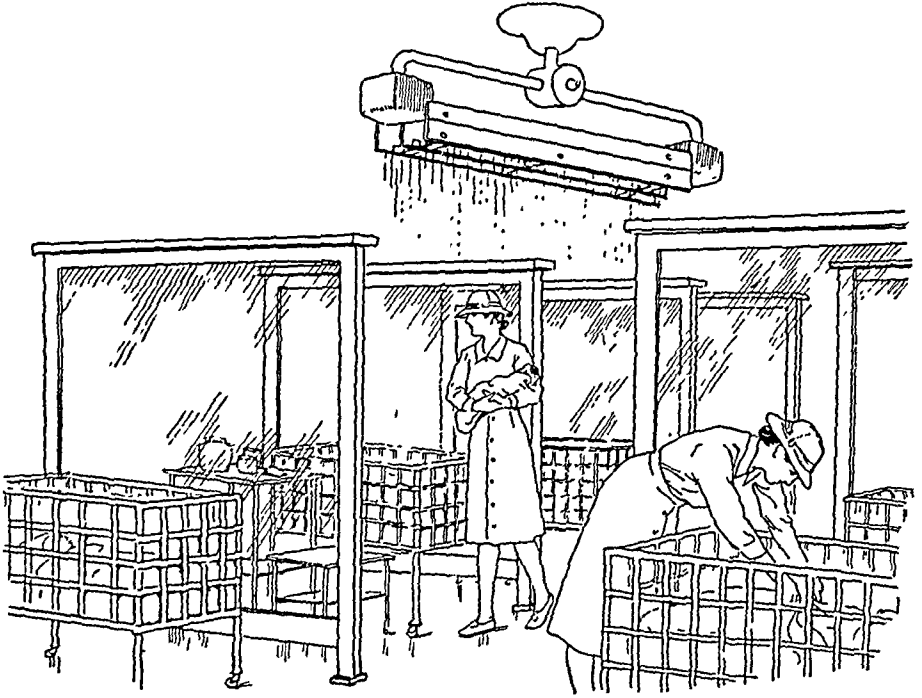

FIG. 170. A source of ultraviolet radiation designed to create a barrier to prevent cross infection between the two sides of an infant's ward. The baffles on the radiator prevent extension of the radiation beyond the confines of the passage way. There is no danger, therefore, of overexposure of the infants in the cubicles. Nurses wear helmets to shade their faces as they continue to cross and pass along the field of the ultraviolet radiation.

the wavelengths around  $2800 \text{ \AA}$ . Viruses and toxins can be destroyed by ultraviolet radiation. It has been shown that it is possible to destroy the rabies virus by means of this radiation without causing complete loss of its immunizing power. Inasmuch as the bactericidal radiation penetrates but a very short distance beneath the body surface, the lethal influence of these rays on micro-organisms can be utilized only when the bacteria lie on the very surface.

Ultraviolet radiation is used to kill bacteria contained in the air. Deryl Hart states that when the air of operating rooms was irradiated, there was a reduction of over 85 per cent in the number of postoperative wound infections; wounds healed more rapidly; the systemic reactions were lessened; and the period of convalescence was shortened. Irradiation of the air in the corridor of an isolation ward prevented the spread of chicken pox (Fig. 170). Barriers of ultraviolet rays were effective in preventing the spread of anti-

ficially introduced bacteria (*Bacteria prodigiosus*) from cubicle to cubicle (Fig 171) It is possible to diminish the number of bacteria in the air by direct irradiation of a room, as in the operating room, or by irradiating re-

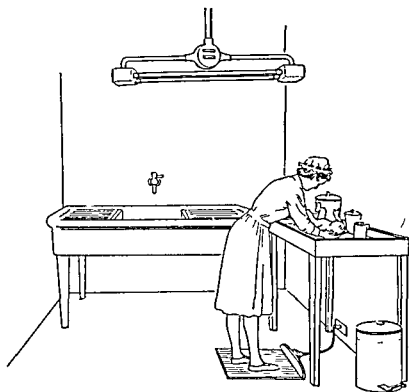

FIG 171 An ultraviolet lamp to minimize the bacterial count of the atmosphere in the dressing room of an infant's nursery This lamp shines continuously except when the nurse enters the room and stands on the treadle in the dressing room This disconnects the current and the radiation ceases so that neither the nurse nor the infant are exposed to it.

circulated air Coblenz has summarized the information concerning the use of ultraviolet lamps for disinfecting purposes by saying that while this radiation can be substituted for actual air displacement in reducing cross infection in chicken pox, measles, and mumps, and with less certainty in reducing the incidence of colds, there is no evidence that will justify high pressure sales promotion of ultraviolet lamps as a cure all or sure preventive of respiratory illness He concluded that disinfection by ultraviolet radiation can serve a useful purpose, but it has its limitations Ultraviolet radiation is also employed to sterilize the water in swimming pools Its effectiveness for this latter purpose does not appear to be sufficiently high to warrant the exclusion of the additional use of chemical bactericides

Ultraviolet radiation can stimulate, inhibit, or destroy ferments and enzymes, depending on the wavelength, the intensity, and the duration of

the exposure. It is possible that the bactericidal influence of this radiation is due not only to a direct, but also to an indirect, action. For instance, the lipids of the skin after exposure to ultraviolet are bactericidal, an effect that is attributed to the active oxygen that is released on contact with bacteria. Other fats and oils exert a bacteria-killing action after irradiation.

The production of a slight leucocytosis and a temporary increase in reticulocytes are additional factors increasing resistance to invading microorganisms. An increase in the macrophages has been described. In mice infected with streptococci, carbon arc radiation decreased the death rate from 23 to 8 per cent. The quartz lamp reduced the rate to 15 per cent.

#### TECHNIQUE OF ULTRAVIOLET RADIATION

Ideally it should be possible to prescribe ultraviolet treatment with the exactness employed in the prescription of a drug. However, the large number of variable factors in both the source and the recipient of the radiation make this difficult. The ultraviolet emanation coming from the sun, for example, varies markedly in different parts of the world, in different seasons, and diurnally; radiations produced by ultraviolet lamps differ greatly in their characteristics and spectrum analysis.

#### TIME

An important consideration in administration of ultraviolet radiation is the time factor. Everything else remaining the same, the effect of radiation varies directly with the time during which it is permitted to shine. Inasmuch as the time factor is important in administration of ultraviolet radiation, an interval timer which either rings a bell or automatically shuts off the current is a useful instrument (Fig. 246). It may help to avoid the serious consequences which have occurred when the subject has fallen asleep during a self-administered treatment. This is a real danger because of the sedative influence of the radiation and one which must be borne in mind by anyone giving himself ultraviolet treatment.

#### DISTANCE

The intensity of the radiation reaching a treated surface depends on the distance between the surface and the lamp. The so-called "inverse square law" applies to all forms of radiation; that is, the intensity of the radiation varies inversely as the square of the distance. For example, diminishing the distance by one-half, quadruples the strength of the radiation. This law is exact for point sources, but inasmuch as the source of the radiation in an

ultraviolet lamp is not a point, the law is found to be somewhat modified in actuality. When, for example, the distance is cut to one half, the intensity is approximately three times as strong (Fig 172). Carbon arc radiations are usually given with the lamp held at a distance of about 30 inches from the skin surface, because of the heat given off by the lamp, and the danger of flying sparks falling on the skin surface. Mercury vapor quartz lamps, however, may be brought as near as 15 inches from the skin surface before the heat causes discomfort.

#### ANGLE OF INCIDENCE

The intensity of the radiation is greatest when the rays strike the exposed surface perpendicularly. The intensity diminishes as the angle of incidence of the rays increases. This factor is of greatest significance when the lamp is held at a short distance from the surface (Fig 173). Treatments with the mercury vapor quartz lamp may be administered with the subject lying, sitting, or standing. For the rapid treatment of a large number of patients, various methods have been used including rotating platforms in front of a battery of lamps and cots arranged in a circle around a powerful arc lamp.

#### DOSAGE DETERMINATION

In the effort to determine accurately the intensity of radiation several methods of measurement have been used. By means of colored pastilles, photo-electric cells and chemical solutions which change color on exposure to ultraviolet radiation (e.g., mixtures of acetone and methylene blue or of carbon tetrachloride and potassium iodide), it is possible to make comparisons of the intensity of radiation from different lamps. However, since the physical intensity of radiation does not necessarily bear a direct relation to the intensity of human skin reaction, these methods of measurement are only of relative value.

The most important criterion of dosage is the reaction evoked in the skin of the individual patient. The reactions to equal intensities of radiation may vary greatly in different persons, depending on local and systemic characteristics. Local differences include thickness of the epidermis, translucence to ultraviolet radiation, and presence or absence of pigmentation. Also different parts of the body in the same individual react differently. Exposed portions of the body surface can tolerate larger quantities of radiation than those ordinarily covered by clothing, mucous membranes can stand an intensity of radiation two or three times greater than can the skin. Systemic variations may be caused by changes in glandular activity. Patients with

the exposure. It is possible that the bactericidal influence of this radiation is due not only to a direct, but also to an indirect, action. For instance, the lipids of the skin after exposure to ultraviolet are bactericidal, an effect that is attributed to the active oxygen that is released on contact with bacteria. Other fats and oils exert a bacteria-killing action after irradiation.

The production of a slight leucocytosis and a temporary increase in reticulocytes are additional factors increasing resistance to invading microorganisms. An increase in the macrophages has been described. In mice infected with streptococci, carbon arc radiation decreased the death rate from 23 to 8 per cent. The quartz lamp reduced the rate to 15 per cent.

#### TECHNIQUE OF ULTRAVIOLET RADIATION

Ideally it should be possible to prescribe ultraviolet treatment with the exactness employed in the prescription of a drug. However, the large number of variable factors in both the source and the recipient of the radiation make this difficult. The ultraviolet emanation coming from the sun, for example, varies markedly in different parts of the world, in different seasons, and diurnally; radiations produced by ultraviolet lamps differ greatly in their characteristics and spectrum analysis.

#### TIME

An important consideration in administration of ultraviolet radiation is the time factor. Everything else remaining the same, the effect of radiation varies directly with the time during which it is permitted to shine. Inasmuch as the time factor is important in administration of ultraviolet radiation, an interval timer which either rings a bell or automatically shuts off the current is a useful instrument (Fig. 246). It may help to avoid the serious consequences which have occurred when the subject has fallen asleep during a self-administered treatment. This is a real danger because of the sedative influence of the radiation and one which must be borne in mind by anyone giving himself ultraviolet treatment.

#### DISTANCE

The intensity of the radiation reaching a treated surface depends on the distance between the surface and the lamp. The so-called "inverse square law" applies to all forms of radiation; that is, the intensity of the radiation varies inversely as the square of the distance. For example, diminishing the distance by one-half, quadruples the strength of the radiation. This law is exact for point sources, but inasmuch as the source of the radiation in an

ultraviolet lamp is not a point, the law is found to be somewhat modified in actuality. When, for example, the distance is cut to one half, the intensity is approximately three times as strong (Fig 172). Carbon arc radiations are usually given with the lamp held at a distance of about 30 inches from the skin surface, because of the heat given off by the lamp, and the danger of flying sparks falling on the skin surface. Mercury vapor quartz lamps, however, may be brought as near as 15 inches from the skin surface before the heat causes discomfort.

#### ANGLE OF INCIDENCE

The intensity of the radiation is greatest when the rays strike the exposed surface perpendicularly. The intensity diminishes as the angle of incidence of the rays increases. This factor is of greatest significance when the lamp is held at a short distance from the surface (Fig 173). Treatments with the mercury vapor quartz lamp may be administered with the subject lying, sitting, or standing. For the rapid treatment of a large number of patients, various methods have been used including rotating platforms in front of a battery of lamps and cots arranged in a circle around a powerful arc lamp.

#### DOSAGE DETERMINATION

In the effort to determine accurately the intensity of radiation several methods of measurement have been used. By means of colored pastilles, photo-electric cells and chemical solutions which change color on exposure to ultraviolet radiation (e.g., mixtures of acetone and methylene blue or of carbon tetrachloride and potassium iodide), it is possible to make comparisons of the intensity of radiation from different lamps. However, since the physical intensity of radiation does not necessarily bear a direct relation to the intensity of human skin reaction, these methods of measurement are only of relative value.

The most important criterion of dosage is the reaction evoked in the skin of the individual patient. The reactions to equal intensities of radiation may vary greatly in different persons, depending on local and systemic characteristics. Local differences include thickness of the epidermis, translucence to ultraviolet radiation, and presence or absence of pigmentation. Also different parts of the body in the same individual react differently. Exposed portions of the body surface can tolerate larger quantities of radiation than those ordinarily covered by clothing, mucous membranes can stand an intensity of radiation two or three times greater than can the skin. Systemic variations may be caused by changes in glandular activity. Patients with

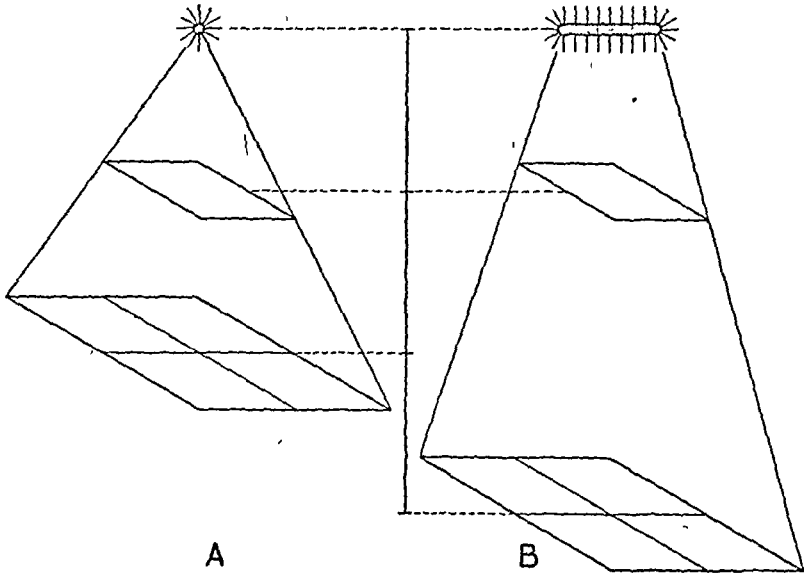

FIG. 172. Inverse square law—*influence of distance on intensity of radiation.* *A.* Point source  
*B.* Non-point source.

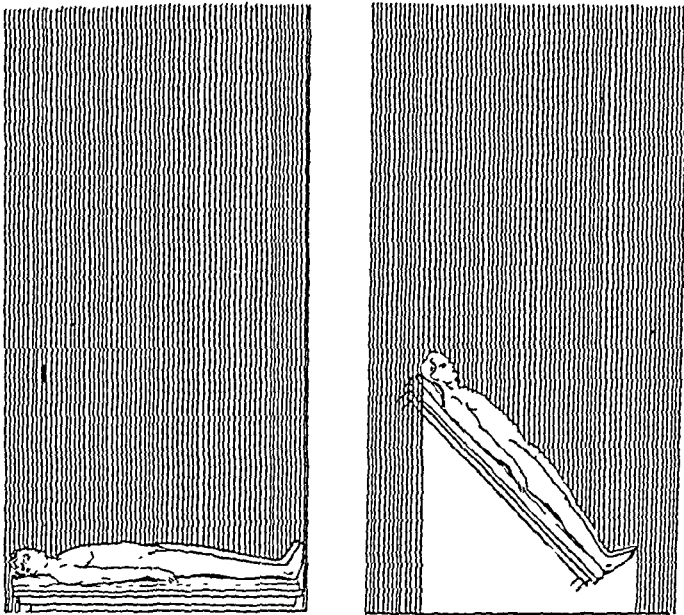

FIG. 173. The maximum radiation occurs when the rays fall perpendicular to the body. The amount of radiation received by the patient becomes less the more obliquely the rays fall on the body. This relationship is expressed quantitatively in Lambert's cosine law.



hyperthyroidism are more sensitive to ultraviolet radiation than is a normal person. In hypothyroidism, sensitivity is less than normal. In persons with high blood pressure and in those suffering from active tuberculosis, sensitivity may be above normal. An increased sensitivity also occurs during the menses. It gradually increases from the second to the seventh month of pregnancy. If a preliminary erythema test is not carried out, it is a good idea to ascertain the patient's reaction to solar radiation by inquiring whether or not he sunburns readily.

Because of the great variations in the intensity of radiations from different sources, and the varying reactions of different individuals, the most exact determination of dosage can be made by observing the reactions of each patient to the radiations from a particular apparatus. To make this determination, small areas of a patient's skin, the inner side of the forearm, the groin, or the back, are exposed for varying intervals of time to a lamp placed at a measured distance (usually about 30 inches) from the skin surface (Fig. 174). The area is covered with a piece of paper in which ten small openings, each about a half inch square, have been cut. The lamp is permitted to shine on the skin through these holes for varying time periods, for fifteen seconds, through the first hole, thirty seconds through the second hole, and forty five seconds through the third hole, and so forth. Special instruments have also been devised for making these measurements, in particular, by Saidman. Four to twenty four hours after the exposure, the irradiated portions of the skin are examined (Fig. 175). Depending on the intensity of the irradiation, there may be no change at all, a very slight erythema, a very intense erythema, and even blistering. The degree of reactions have been artificially divided into four groups. (1) First degree erythema is one in which but slight reddening of the skin appears within six to twelve hours after exposure and disappears within twenty four hours. (2) Second degree erythema is like that of a slight sunburn. The reaction is followed by mild peeling and, in normal persons, by pigmentation. (3) Third degree erythema is like the reaction caused by a severe sunburn, with itching and burning sensations, the epidermis subsequently comes off in large sheets or peels off in strips. The marked erythema, which gradually fades in about one week's time, is followed by definite pigmentation. (4) Fourth degree erythema is the most intense, with blister formation. After its subsidence there is no evidence of the deep tissue destruction which follows a burn. Intensities of radiation sufficient to cause first and second degree erythemas are used for general body radiation, third and fourth degree erythemas for local changes.

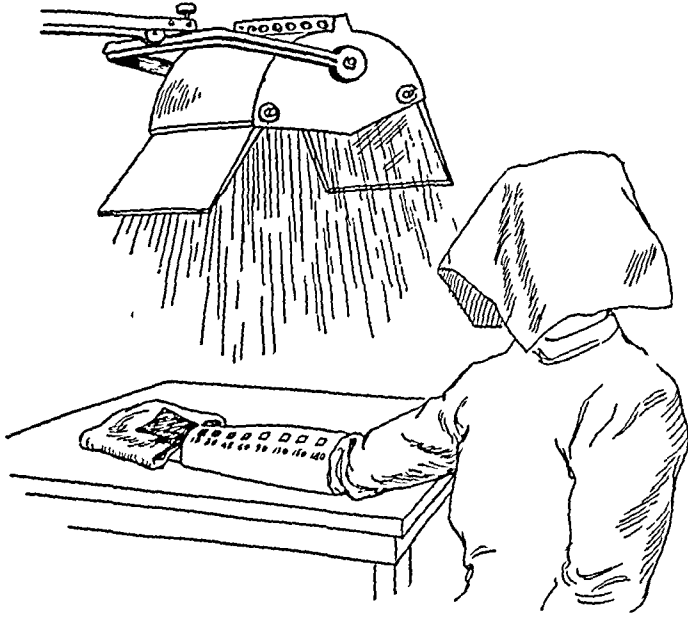

FIG. 174. Technique for testing erythema sensitivity of the skin. By moving the strip of paper under the paper cuff, the skin under the square openings in the paper cuff are exposed for increasing periods of time.

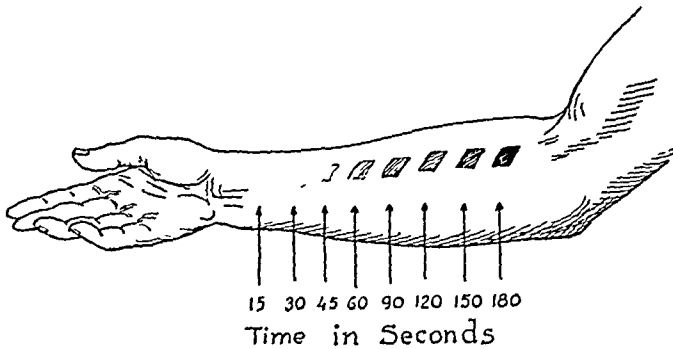

FIG. 175. Increasing reactions as the time period of ultraviolet radiation is prolonged.

## GENERAL BODY RADIATION

When giving ultraviolet treatment, the technician should be protected against possible overexposure of parts not covered by clothing. The eyes, especially, should be protected. A close fitting pair of goggles which cut

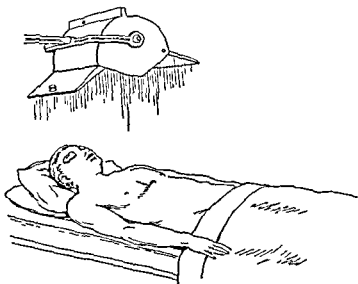

FIG 176 Technique for general body irradiation with a hot mercury quartz lamp

out all the ultraviolet radiation should be worn constantly to prevent development of conjunctivitis. If the operator is exposed to the radiation for long periods of time, it may be wise to protect the hands with gloves and the face with a hood (Fig 176).

The room in which the ultraviolet treatment is administered should be well ventilated and at a temperature of about  $70^{\circ}$  F. If the patient feels chilly, he may be made more comfortable by placing an electric heating pad at his feet or by exposing him to the radiation from an infra red or a photothermal lamp. Patients are usually treated lying on a couch or table, which should be low enough to leave a distance of 30 to 36 inches between the skin surface and the burner. For purposes of general radiation, the patient should be entirely undressed. A sheet may be used to cover him until the treatment is started. A loin cloth or towel may be placed over the pubic area. The disadvantage of such local coverings is that they may not be applied to exactly the same region at subsequent treatments. The danger then exists that a small area will receive an intensity of radiation to which the surrounding skin has become gradually accustomed, but which may cause violent erythema in this region. If, when using a lamp such as a mercury

vapor in quartz, two separate exposures are applied to the anterior and two to the posterior aspects of the body, the upper part of the body is exposed while the lower part is covered with a sheet from the suprapubic region to and including the feet. The lamp is centered at a line corresponding to the level of the nipples. The sheet is then moved up to cover the skin area which has just been exposed to permit treatment of the lower part of the body. The lamp is moved down so that it is centered over the region of the mid-thighs. The same technique is used for the exposure of the back and then the buttocks and posterior aspects of the lower extremities. The eyes should be protected from the ultraviolet radiation with goggles, or pads of moistened absorbent cotton or oval-shaped pieces of dark cardboard held in place by a string tied around the head (Fig. 47). These latter techniques are best because they exclude less skin surface and yet accomplish their purpose. In young children it may be necessary to place some object such as a thin board, a piece of cardboard, or a cloth in a manner which will throw a shadow over the face and so exclude the eyes from radiation.

When using the mercury vapor quartz lamp, it is wise to take the following precautions. The burner of the lamp should not be touched with the fingers, and it should be wiped with alcohol to keep it free from grease or dirt. The reflector should also be kept clean to secure maximum reflection from the lamp. As a preliminary to treatment, the current should be turned on and kept on for a period of at least five minutes, or better, ten, during which an optimum intensity is reached. If the lamp operates on direct current, it is essential that the polarity as shown by the indicator be correct; otherwise the burner will be damaged. The lamp should be placed so that its burner is not directly over the patient, but a little to one side to avoid the possibility, though it be remote, of a broken burner spilling hot mercury on the skin. The patient can be turned toward the lamp so that the rays fall perpendicularly to the body's surface. If it is necessary to tilt the burner to start the machine, this should be done gradually. Failure of the lamp to light may be due to a break in the electric wiring or to a disturbance of the vacuum in the burner. Should the lamp get too hot, which may happen if the hood has been kept closed for too long a period of time, the light may go out. It is then necessary to open the hood and permit the lamp to cool before restarting it.

The distance at which the ultraviolet lamp is kept from the body and the time during which its radiation is permitted to act must be governed by the reaction of the patient and the therapeutic indications for the treatment. Systemic conditions suitable for ultraviolet therapy include such diseases as

non pulmonary tuberculosis, rickets, infantile tetany, and other conditions for which the so-called tonic doses of radiation are valuable. When the treatments are given for their systemic effect and a large portion of the body surface is to be irradiated, it is advisable to begin with suberythema doses and to increase the dose gradually to avoid a marked reaction. Saidman believes that at subsequent radiations the intensity should be increased by between one fifth and one tenth of the minimal erythema dose. He advises a first or second degree erythema dose in the regional radiation of different parts of the body, as for example, the neck in the treatment of tuberculous glands and of cervical brachial neuralgia, the chest, in the treatment of asthma and pertussis, the lumbar region, in tuberculous peritonitis, nephritis, colitis, and sciatica, the extremities for neuralgia and circulatory disorders. For the treatment of smaller local areas, Saidman suggests that third or fourth degree erythemas may be administered. In the group of diseases so treated he lists boils, carbuncles, furuncles, acne, alopecia areata, psoriasis, ringworm, and lupus vulgaris. Another skin condition, erysipelas, is satisfactorily treated if the dose is ten or more times the minimum required to cause an erythema. Saidman also administers third and fourth degree erythema doses to local regions for analgesic and anticongestive effects, in the treatment of pneumonia, pleurisy, and intercostal neuralgia.

A common technique when using the mercury vapor quartz lamp is to set the burner at a distance of about 30 inches from the surface and to irradiate each of the four sections of the body, the two on the anterior and two on the posterior aspects, for one half minute at the initial exposure. At subsequent treatments administered at intervals of about every other day, the time of exposure is increased by one half minute to each of the irradiated parts. This rate of increase is maintained until each section receives five minutes of radiation. This makes a total of twenty minutes of exposure to the entire body. Treatments of longer duration than this are impractical in a busy office or clinic and even in the private home. Further increase of dosage is accomplished by diminishing the distance of the lamp from the skin surface. Although set rules for time and distance cannot be universally applicable, a general scheme for body irradiation is indicated in Table II.

Some physicians are of the opinion that the best systemic effects of ultraviolet radiation are produced by irradiating a single area, say, about a foot square rather than the entire body surface. Erythema doses are administered to such regions and repeated at intervals of a week or so after the reaction has subsided.

To treat local areas it is convenient to use a specially cooled mercury quartz

TABLE II  
GENERAL SCHEME FOR BODY ULTRAVIOLET  
IRRADIATION

TREATMENT NUMBER	DISTANCE FROM BURNER IN INCHES	TIME OF EXPOSURE	
		Each of 4 Areas (min.)	Total Exposure (min.)
1	30	$\frac{1}{2}$	2
2	30	1	4
3	30	$1\frac{1}{2}$	6
4	30	2	8
5	30	$2\frac{1}{2}$	10
6	30	3	12
7	30	$3\frac{1}{2}$	14
8	30	4	16
9	30	$4\frac{1}{2}$	18
10	30	5	20
11	29	5	20
12	28	5	20
13	27	5	20
14	26	5	20
15	25	5	20
16	24	5	20

generator, or a "cold quartz" applicator. The "Kromayer lamp" is particularly suitable for irradiation of mucous membrane in the body cavities; it is equipped with quartz applicators in shapes useful for this purpose. This apparatus permits a more energetic treatment than does the air-cooled lamp. A flat quartz lens fitted to the Kromayer lamp is pressed against the superficial layers of the skin with resultant dehematization. The penetration of the ultraviolet radiation is greater than if the skin circulation is permitted to remain unaltered (Fig. 177).

If the subject who has been receiving gradually increasing doses of ultraviolet absents himself from these treatments for a period of time, it is usually necessary, on the resumption of treatment, to begin with a dose less than that used on the last treatment. For example, after an interval of ten days it is best to begin with a dose one-half of that last administered; after an interval of three weeks it is advisable to start with doses similar to those used at the very beginning of the treatment.

## INDICATIONS

The therapeutic uses of ultraviolet radiation are discussed in the section on clinical procedures (Part II). The physiological changes produced by ultraviolet radiation indicate its possible therapeutic applications. Its ability

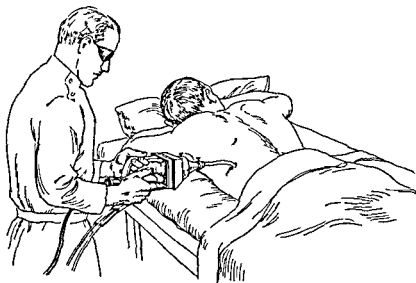

FIG 177 A water cooled hot quartz (Kromayer) lamp applied to a wound

to produce vitamin D suggests its use in the treatment of disturbances of calcium and phosphorus metabolism. Its value in rickets, osteomalacia, and infantile tetany has been established, as it has in cases of interference with normal calcium deposition in the formation of bones and teeth. For prophylactic purposes an adequate supply of vitamin D should be assured infants and adolescents, and recourse may be had to artificial ultraviolet radiation when other sources fail. There does not appear to be any great difference in the antirachitic effectiveness in human beings, of vitamin D administered in the form of cod liver oil, a mixture of fish liver oils, irradiated cholesterol, irradiated fresh milk, or irradiated evaporated milk.

Cawadias believes that it is impossible to replace ultraviolet radiation with vitamin D administered by mouth because the vitamin may not be absorbed from the gastro intestinal tract. He states that frequently in treating rickets with ultraviolet light, attacks of tetany may occur because of a lowering of blood calcium as it is removed to the bones. To correct this, he suggests the use of additional radiation and increased calcium intake.

Antepartum irradiation of the mother is of value not only for its influence on the calcium metabolism of the fetus in utero, but also to prevent the de

pletion of calcium stored within the body of the mother. This is of particular importance in prevention of maternal dental caries. After caries has occurred in the teeth, ultraviolet radiation does not appear to be of any special value. Because of its effect on calcium metabolism, ultraviolet radiation has also been administered for the treatment of spasmophilia and laryngismus stridulus.

Ultraviolet radiation is used extensively in various forms of tuberculosis. However, it must be considered as an adjunct to the other forms of treatment employed in the effort to increase the body's resistance. In bone and joint tuberculosis emphasis is placed on conservative treatment, in which ultraviolet radiation plays an important part. Such conservative treatment usually results in healing with useful action and retention of motion without recurrence of the disease. Intestinal tuberculosis is another indication for the use of ultraviolet radiation. Local radiation is valuable in the treatment of tuberculous fistula in ano and of anorectal tuberculosis ulceration.

In tuberculous involvement of the genito-urinary tract, ultraviolet light is advised with or without conjoint use of surgery. When only one kidney is involved, the indication is for nephrectomy; when the lesion is bilateral, dependence must be placed on radiation and constitutional therapy.

In tuberculosis of the urinary bladder, local applications are made in addition to generalized radiation. So also in the treatment of tuberculous epididymitis, orchitis, and salpingitis.

Strandberg states that the period of treatment for tuberculosis of the larynx by generalized carbon arc irradiation can be shortened by supplementing this with local irradiation. Ultraviolet radiation can be applied directly to the involved larynx by mirrors reflecting sunlight, carbon arc radiation, or more conveniently, by quartz rods attached to an ultraviolet light source. Systemic and local applications are also made in the care of tuberculosis involving the eye, the ear, and the nose.

A combination of general and local ultraviolet radiation has proved of value in the treatment of tuberculous lymph nodes. In most instances, if treatment is applied early, the inflammatory symptoms first increase and then disappear. In later stages, caseation may require surgical intervention; the subsequent use of ultraviolet facilitates healing. If a sinus develops, local irradiation by means of a quartz rod, as in tuberculous sinuses elsewhere, is frequently followed by closure of the tract.

Tuberculosis of the skin manifests itself in several forms. Lupus vulgaris responds well to general and intense local radiation. The best results are reported to follow carbon arc radiation as applied by Finsen. Cipollaro em-



ploys ultraviolet rays, in conjunction with other measures such as the Gerson diet, x rays, and cauterization, in scrofuloderma, papulonecrotic tubercles, and erythema induratum of Bazin

There are differences of opinion concerning the merit of ultraviolet radiation in the treatment of pulmonary tuberculosis. Mayer states "For un complicated pulmonary tuberculosis, no clinical evidence is at hand to prove the indication for light therapy." Banvai felt that the therapeutic results achieved in a selected group of sanatorium patients justified the further use of carbon arc radiation in the treatment of pulmonary tuberculosis and tuberculous pleurisy. Ultraviolet radiation should be cautiously applied in any form of tuberculosis because of the danger of lighting up a quiescent pulmonary lesion. Development of a temperature above 100° F (37.8° C), occurrence of malaise, hemoptysis, or other symptoms of activity indicate interruption of radiation.

Because of its systemic effects, ultraviolet radiation has been advised in the treatment of a large number of conditions. Whether this radiation has any so-called tonic effect is still a moot question. There is a dearth of objective physiological data to prove the correctness of this claim. After ultraviolet radiation the patient has a healthier appearance, his skin has a better texture, his muscles are firmer, psychologically there is no doubt that a person who can see a mild erythema and subsequent pigmentation of his skin feels better because of his healthful appearance. However, other physical conditions attending the development of such ultraviolet reactions outdoors, such as bathing and the movements of air against the skin, may furnish other causes for improvement.

There are differences of opinion concerning the therapeutic value of ultraviolet radiation in many diseases. In some of these, radiation is helpful, but not sufficiently so to warrant exclusion of other methods of treatment. The number of variable factors may be so large as to make it difficult to evaluate the use of ultraviolet radiation on a clinical basis. However, numerous observers who have had an opportunity to irradiate many patients suffering from a great diversity of diseases, have concluded that ultraviolet radiation is helpful in some cases. The list of ailments which can be favorably influenced is a large one; some of these have been mentioned, others will be referred to in greater detail in the chapters comprising the section on clinical procedures.

In the care of the arthritides, ultraviolet radiation is a valuable adjunct in both the atrophic and the hypertrophic forms. When arthritis is complicated by the presence of psoriasis, radiation serves a dual purpose by benefiting

both the skin and the joint lesions. Because of its influence on calcium metabolism it is logical to apply ultraviolet radiation to diseases of the bone, such as delayed union of fractures, osteomalacia, fragillitas osseum, and osteomyelitis. It is also employed in the treatment of fibrositis.

✓ The local changes produced by ultraviolet radiation have a wide application in medicine. The intensity and extent of the application varies with the therapeutic objective. Eidinow employs this radiation as an accurately controlled means of counterirritation. Usually he exposes a skin area measuring about 12 by 10 inches. The irradiated region and the surrounding skin margin are immediately covered by overlapping strips of adhesive plaster 2 to 2½ inches wide. These are left undisturbed for fourteen days. The strapping is then removed and the region is cleansed with methylated ether or oil of eucalyptus. He advocates this technique in the treatment of acutely painful conditions such as sciatica, brachial neuritis, lumbago, fibrositis, and acute joints swollen by effusion fluid.

The ability of ultraviolet radiation to cause an increase in the number of red blood cells forms the basis for its use as an adjunct in the treatment of secondary anemia. It has also been advised for pernicious anemia because of its detoxifying action on blood serum. It may cause a temporary lowering of blood pressure in hypertension. Ultraviolet radiation has been recommended for cardiac dyspnea and for carbon monoxide poisoning.

The value of ultraviolet radiation in the care of diseases of the gums such as pyorrhea, Vincent's stomatitis, is still a matter of debate. It is employed, if at all, with other dental procedures. The wound-stimulating effect of ultraviolet can be applied in the mouth as well as in other portions of the body. Ultraviolet radiation has been recommended in the treatment of pylorospasm, pyloric stenosis, and colitis.

For its sedative influence, ultraviolet radiation has been used in insomnia, neurasthenia, melancholia, and hysteria. The counterirritation which it produces may account for the assertions of its value in the treatment of neuritis.

Ultraviolet is said to be of value in the treatment of tissues of the eye in conditions such as blepharitis, herpetic eruptions, trachoma, chronic conjunctivitis, corneal ulcers, keratitis, and episcleritis. Lesions of the external auditory canal including furunculosis, eczema, erisypelas, and pruritus can be treated with ultraviolet radiation applied through quartz rods. The stimulating power of the radiation has been used for the care of indolent ulcers of the tympanum and of sluggish mastoidectomy wounds. Similarly, the radiation has been used to influence ulcers and wounds occurring within the nose.

Ultraviolet radiation has been used for many pathological conditions of the skin. MacKee and Cipollaro have found it useful (either alone or when used in conjunction with other treatments) in erysipelas, certain types of cutaneous and subcutaneous tuberculosis, acne vulgaris, adenoma sebaceum, pityriasis rosea, parapsoriasis, psoriasis, telangectasia, indolent ulcers, wounds, and port wine nevi. In erysipelas, the therapeutic results have been brilliant.

Ultraviolet radiation stimulates healing of indolent ulcers and wounds. A satisfactory technique is to irradiate the involved surface with gradually increasing intensities of radiation. Eidinow's method of treating varicose ulcers is to expose the ulcer and skin area to one and one half inches surrounding the edge of the ulcer to massive doses (about six erythema doses). He uses a quartz air-cooled mercury vapor lamp. After the exposure, an elastic adhesive bandage is tightly wrapped from the base of the toes, over the feet including the heel, and up to the knees. The bandage is kept on for a week. It is then removed, the skin cleansed with acetone and the treatment repeated.

Many English authors comment favorably on the use of ultraviolet radiation in children for the care of marasmus, malnutrition, sleeplessness, fretfulness, irritability, bronchitis, and subacute rheumatism. In pregnancy, the radiation has been advised for the treatment of pre-eclamptic toxemia, for eclampsia, and as a prophylactic agent to the nipples in the last month of pregnancy.

In surgery, we have employed ultraviolet radiation as a routine measure, preoperatively and postoperatively. It is our impression from clinical observations that recuperation of patients so treated is improved. Heuer urges its incorporation into general surgical services as a means of diminishing the number of chronic surgical cases, especially the tuberculous. In his opinion this method of treatment can also be applied to chronic empyema, lung abscess, osteomyelitis, and many other conditions. Convalescence is shortened. Harvey and Meleny call attention to the work of Hans Havlicek who treated 108 cases of peritonitis following appendicitis with ultraviolet radiation, without a single death. Havlicek says that while the initial effect of ultraviolet radiation during operation is a circulatory one, the subsequent strangely favorable course of irradiated cases can be attributed principally to the absence of symptoms of shock and to an activation of the defense powers of the body resembling non specific therapy.

The fact that ultraviolet radiation is bactericidal has aroused the hope of many workers that it might be possible to destroy micro organisms in the blood stream, as in bacteremias. Theoretically, it might appear feasible to

create an arteriovenous anastomosis of quartz tubing outside of the body through which blood could be shunted for irradiation. Unfortunately, while the idea may be basically simple from a purely mechanical point of view,

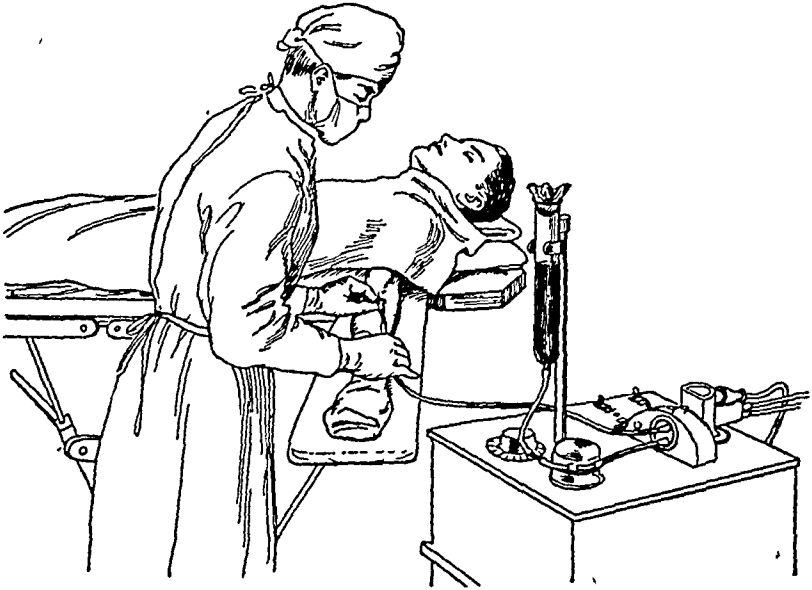

FIG 178. A technique for the ultraviolet radiation of the blood.

the physiological considerations involved are very complex. A method of direct irradiation of the blood was developed by E. K. Knott of Seattle some years ago (Fig. 178).

Using a water-cooled mercury quartz generator, he first determined the red blood cell tolerance and found there was no change when exposed up to seventy seconds. Animal experiments were then performed. Strains of staphylococcus aureus and streptococcus hemolyticus were injected intravenously into dogs and cultures were taken to determine that acute septicemia was existing. Two veins were tapped and the blood withdrawn from the one vein was irradiated with ultraviolet light as it passed through a quartz glass chamber at a measured rate and was pumped back into circulation through the other vein. The estimated total blood volume was treated in this manner. All the animals treated died on the fifth to seventh day following treatment. However, at death the treated animals consistently had negative blood cultures. The cause of death appeared to be anaphylactic shock. All the control animals died and had positive blood cultures at the time of death. During one of the experiments, the apparatus broke down after 25 per cent of the blood volume had been treated. This animal had a negative blood culture on the fifth day and made a complete recovery without any symptoms of anaphylaxis. It was finally determined that it required  $1/16$  to  $1/20$  of the blood

volume to be irradiated in order to obtain a consistent response. It was found by studies on the white blood cells that leucocytes are very sensitive to ultraviolet light and that there is a difference of a few seconds in exposure between that which is ineffective and that which destroys the white blood cells, but in between these two ranges the phagocytic index of the leucocytes is increased 50 per cent.

Ultraviolet blood irradiation was introduced clinically in 1928 when it was given to a patient with septic abortion complicated by hemolytic streptococcus septicemia, and who made an uneventful recovery. In 1933 it was tried again in a case of hemolytic streptococcus septicemia, which also recovered.

Since that time several thousand treatments have been reported by various clinicians. They state they have had no untoward effects. They have employed it mainly for infectious conditions. It has been used with reported success and recommended for the following conditions: septicemia due to staphylococcus albus, hemolytic staphylococcus aureus, streptococcus viridans, hemolytic streptococcus, escherichia coli, and to the colon bacillus, puerperal sepsis, septic abortions, chronic pelvic inflammatory disease, carbuncles, acute and chronic furunculosis, peritonitis, cellulitis, thrombophlebitis, cystitis, otitis media, streptococcus pharyngitis, paralytic ileus, chronic non-healing wounds, cholecystitis, pneumococcal and virus pneumonia, upper respiratory infections, mumps, poliomyelitis, encephalitis, herpes zoster, intrinsic and intractable asthma, acute and chronic bronchitis, rheumatic fever, acute rheumatoid arthritis.

In the experience of the various individuals using this form of therapy, the sulfonamides and the iodides should not be given for five days to a week following a treatment, presumably because of photosensitization. They feel that there is no contraindication to the giving of an irradiation following the use of these drugs. It is stated that this form of therapy is definitely of no value in neoplasms, leukemia, psoriasis, Hodgkin's, subacute bacterial endocarditis, and syphilis.

The technique consists of withdrawing 15 cc of blood per pound of body weight. As it is withdrawn it is citrated and then passed through a quartz glass chamber which is exposed to a water-cooled ultraviolet lamp of the Kromayer type at a fixed rate of 10 cc in twenty seconds. A shutter revolves between the chamber and the lamp so that the actual exposure time is ten seconds for 10 cc. After the blood has passed through the quartz chamber it is returned to the circulation. The whole procedure is carried out under aseptic conditions. The patients do not have to be hospitalized and may be treated on an ambulatory basis if their disease warrants it.

A simpler technique is the removal of about 5 to 8 cc of blood, which is

citrated, irradiated with a mercury vapor lamp, and then injected intramuscularly. Injections are repeated two or three times a week for from fourteen to eighteen times. This method is proposed for the relief of pain in arthritis and in chronic muscular rheumatism and in the treatment of acute allergic diseases of the skin. It is really a form of protein therapy.

#### CONTRAINDICATIONS

This subject involves the consideration of the quantity of the applied ultraviolet. Even a normal person cannot tolerate strong and prolonged exposures. There are individuals who are unusually sensitive to ultraviolet radiation. They may develop headaches, symptoms of malaise, circumoral herpes simplex, or vesicular eruptions on the skin, and an elevation of systemic temperature after relatively mild exposures to the rays. As these people put it, they "cannot stand the sun." Overdoses of ultraviolet radiation in relatively normal people can produce similar symptoms. Occasionally individuals who have administered ultraviolet radiation to themselves have fallen asleep during such exposures and have developed symptoms of severe sunburn. It is therefore best to have some other person present during all ultraviolet exposures to prevent this not infrequent occurrence.

The presence of certain systemic and cutaneous diseases makes it necessary to apply ultraviolet radiation with great caution, if at all. A list of such diseases includes hyperthyroidism, diabetes, decompensated heart disease, kidney involvement as in nephritis and advanced bilateral tuberculosis. Tuberculosis of the suprarenal glands and, in some instances, of the tracheo-bronchial glands are regarded as contraindications. Harm can be produced by ultraviolet in pulmonary tuberculosis. The symptoms of this disease which indicate that ultraviolet be withheld have been mentioned (page 316). Rollier cautions that in the caseous type of tuberculosis, peritonitis, vomiting, and fever may occur after exposure to the sun. Ultraviolet radiation is said to be poorly tolerated by very nervous persons and by those markedly cachectic.

The Council on Physical Therapy of the American Medical Association calls attention to certain skin disorders in which exposure to ultraviolet radiation may cause an exacerbation, provoke an attack, or produce other injurious effects. These skin conditions include acute eczema, some cases of psoriasis, lupus erythematosus, herpes simplex, xeroderma pigmentosum, farmer's skin, and premature senile skin. The Council further states that frequently repeated exposures to ultraviolet radiation over a long period of time in persons, especially children, who have a low tolerance to ultraviolet

rays, may lead to degenerative changes in the skin, such as atrophy, anomalies in pigmentation, keratoses, and rarely, cancer. Attention has been called to unusual light sensitivity occurring in hydroa vacciniforme, pellagra, and summer prurigo. As has been stated previously, some skins can be made sensitive to light by application of certain substances such as eosin, oil of bergamot, some perfumes and other substances. Sensitive persons should avoid not only direct sunlight after radiation from artificial lamps, but also diffused sunlight and reflected light from snow, water, and sand. MacKee and Cipollaro declare that if such patients find it necessary at times to be exposed to strong solar light, the face and hands should be protected with veils, walnut stain, or alcoholic solution of glycerite of tannin, or by a cream containing dark substances such as burnt sugar or sulphonated bitumen. The preparation which they have thus far found most satisfactory to protect the skin against the effects of ultraviolet radiation is the following:

Salol	1	Gr V
Tannic acid	5	3 ss
Lanolin anhydrous		
Petrolatum flavosum aa q.s ad 100		aa q.s ad 31

Luckiesch and his co-workers sought a method for prophylaxis against sunburn for army aviators who might be forced to take to life rafts or to exist in the desert. They found that dark red vet petrolatum was quite opaque to erythema energy, that phenyl salicylate (salol) was an excellent protection from ultraviolet radiation when put up in 10 per cent cream, and that 10 per cent phenyl salicylate incorporated in the dark red vet petrolatum may be a suitable agent for protection of marooned aviators.

## REFERENCES

- BACHEM, A, FANTUS, B. Evaluation of skin protection against ultraviolet rays *Arch Phys Therapy*, 20 69-76, 1939
- BANYAI, P L. Carbon arc treatment in pulmonary and pleuritic tuberculosis *Arch Phys Therapy*, 18 205-213, 1937
- BERNHARD, O. Thirty five years of heliotherapy *Radiologica*, 1 1-4, 1937
- BROWN and SAMPSON. Quoted by G A Moore, Intestinal Tuberculosis *Rhode Island M J* 8 123, 1937
- CAWADIAS, A P. Ultraviolet irradiation. Clinical applications *Brit J Phys Med* 12 70, 1937
- CIPOLLARO, A C. Treatments of cutaneous tuberculosis *Arch Phys Therapy*, 18 415, 1937

- CIPOLLARO, A. C. Role of ultraviolet therapy in treatment of diseases of the skin. *Med. Rec.*, 149 : 415-420, 1939.
- COBLENTZ, W. W. The physical aspects of ultraviolet therapy. *J.A.M.A.*, 111 : 419, 1938.
- COBLENTZ, W. W. Sources of ultraviolet and infra-red radiation used in therapy. In *Handbook of Physical Therapy*. Chicago, American Medical Association, 1939.
- COBLENTZ, W. W. Ultraviolet lamps for disinfecting purposes. *J.A.M.A.*, 129 : 1166, 1945.
- COULTER, J. S., and HARDT, L. L. Ultraviolet radiation in gastro-intestinal tuberculosis. *Arch. Phys. Therapy*, 20 : 143-148, 1939.
- EIDINOW, A. The uses and abuses of ultraviolet radiation. *Practitioner*, 141 : 154, 1938.
- EIDINOW, A. Photodynamic action of sulfanilamide compounds. *Brit. J. Phys. Med.*, 2 : 150-154, 1939.
- ELDER, H. L. The use of iron therapy by the normal individual for the prevention of sunburn. *Arch. Pediatrics*, 52 : 633, 1935.
- ELLINGER, F. Quoted by J. S. Mitchell. The origin of the erythema curve and the pharmacological action of ultraviolet radiation. *Proc. Roy. Soc.*, 126 : 241, 1938.
- ELLINGER, F. Influence of ultraviolet rays on body weight. *Radiology*, 32 : 157-160, 1939.
- FISHBACK, D., GUTTMAN, S., and ABRAMSON, E. An objective method of determining blood velocity (fluorescein method). *Am. J. M. Sc.*, 203 : 535-539, 1942.
- GOECKERMAN, W. H. Tar and ultraviolet radiation in the treatment of psoriasis. *Brit. J. Phys. Med.*, 12 : 215, 1933.
- HARVEY, H. D., and MELENEY, F. L. Peritonitis. *J. Surg., Gynec. & Obst.*, 67 : 4 : 339, 1938.
- HAVLICEK, H., and JONASCH, A. Relation of ultraviolet irradiation of the operative field to anaphylaxis and non-specific therapy. *Klin. Wchnschr.* 16 : 1183-1187, 1937.
- HEUER, G. Heliotherapy as an adjunct in the treatment of chronic surgical conditions. *Med. Bull., Univ. Cincinnati*, Nov., 1925.
- JAUSION, H. Variations in photopathology related to climate and seasons. *Ann. Inst. d'actinol.*, 13 : 26-33, 1938.
- LAURENS, H. Sunlight and Health. *Scient. Monthly*, 42 : 312, 1936.
- LAURENS, H. The physiologic effects of ultraviolet radiation. In *Handbook of Physical Therapy*. Chicago, American Medical Association, 1939.
- LUCKIESCH, M., TAYLOR, A. H., COLE, H. N., and SOLLMAN, T. Protective skin coatings for the prevention of sunburn. *J.A.M.A.*, 130 : 1, 1946.



- MACKEE, G M, and CIPOLLARO, A C Ultraviolet therapy in dermatology  
In Handbook of Physical Therapy Chicago, American Medical Association,  
1939
- MAYER, E Light therapy and roentgen therapy in tuberculosis In Handbook of  
Physical Therapy, Ed 3 Chicago, American Medical Association, 1939
- MAYER, E Technic of artificial radiation In Principles and Practice of Physical  
Therapy Hagerstown, Maryland, Prior, 1932
- MILEY, G Ultraviolet blood irradiation therapy (Knott technic) in acute pyo-  
genic infections *Am J Surg*, 57 493, 1942.
- MILEY, G Ultraviolet blood irradiation therapy (Knott technic) in non healing  
wounds *Am J Surg* 65 368, 1944
- MILEY, G P, SEIDEL, R E, and CHRISTENSEN, J A Ultraviolet blood irradi-  
ation therapy of apparently intractable bronchial asthma *Arch Phys Med*, 27  
24, 1946
- PAUL, N C The Influence of Sunlight in the Production of Cancer London,  
H K Lewis, 1918
- PINCUSSEN, L Effect of ultraviolet and visible rays on carbohydrate metabolism  
*Arch Phys Therapy* 18 750-763, 1937
- ROFFO, A H *Strahlentherapie*, 53 317, 1935
- ROLLIER, A Technic and dosage of sun treatment of tuberculous peritonitis  
*Strahlentherapie* 60 164-169, 1937
- STRANDBERG, O Heliotherapy and artificial light, treatment of tuberculosis con-  
ditions and particularly laryngeal tuberculosis *JAMA*, 90 1595-1602
- ZEISLER, E The treatment of acne vulgaris *Arch Phys Therapy*, 11 651, 1935

## CHAPTER XI

# MASSAGE

**T**HE ABILITY TO GIVE EXPERT MASSAGE REQUIRES knowledge and experience that can be gained only by practicing the art at frequent intervals and for a prolonged period of time. Some persons have not the innate capacity necessary for expert application of massage. For these reasons and others, physicians often do not attempt to administer massage, but refer their patients to a lay masseur or a masseuse. Nevertheless, numerous occasions arise in the general practice of medicine in which ability to give massage is a valuable asset to the physician. While he may not hope to become expert, it is not difficult for the average practitioner to learn to perform massage sufficiently well to obtain satisfactory therapeutic results.

The physician will find that this knowledge of massage has several advantages: It permits him to detect variations from the normal which he might otherwise miss; for example, fibrositic nodules may be discovered during the administration of a massage and the progress of the fibrositis from day to day can be appreciated when the practitioner himself applies the procedure. In certain conditions, for instance, recent fractures, his knowledge of disease enables the doctor to apply massage more intelligently than a layman could. The patient appreciates the personal attention given to him when his physician ministers to him directly and not through an intermediary. This psychological factor of which many physicians are probably unaware, offers an explanation for the widespread activities of irregular practitioners. The physical "laying on of hands" has a reassuring value even though these hands be not guided by honest and scientific reason. Frequently, it is more convenient for both patient and physician to have massage applied at once, rather than to have the patient sent to a masseur or to have the masseur go to the patient. Often massage may be combined with other physical and chemical ministrations which the doctor gives, and to defer the massage part of the prescription to some other time may be inexpedient. If for one reason or another, the physician is unable to give the massage, a knowl-

edge of the art will permit him to direct its application by the lay masseur. Many capable masseurs are available who have developed a technical expertise which the average doctor cannot hope to equal. They could perform their work more intelligently if the referring doctor gave them an exact prescription indicating the type of massage, its intensity and duration.

### PHYSIOLOGY

Massage produces changes through reflex and mechanical reactions. The muscular contraction which follows superficial stroking is a generally known phenomenon, which may be observed in the cremasteric reflex, abdominal reflex, and so forth. Gentle stroking massage will cause muscular relaxation reflexly, rapid stroking will cause contraction reflexly. Some authorities believe that the mechanical factor is essentially responsible for the diminution in the size of local areas of swelling following massage, others, that the reflex factor is primarily responsible. The fact that effleurage will reduce the size of an area of swelling is offered as proof of the reflex action. The intermittent compression and relaxation produced by massage has sufficient effect on the venous circulation to increase blood flow in the skin of the extremities—a factor that is of advantage in the treatment of patients who are confined to bed and deprived of the circulatory stimulating influence of the muscular contraction which occurs on walking. The erythema caused by massage may be due to the elaboration of an histamine like substance. Assuming that both reflex and mechanical factors play a part in the effect produced by massage, it still remains difficult to determine the proportion of change for which each of these two factors is responsible.

Pemberton considers that, in general, massage does not exert a direct and definite influence on metabolism. Whatever influence does occur is a result of the changes produced in circulation. A 10 to 15 per cent increase in oxygen consumption and in carbon dioxide production may follow general or abdominal massage. The acid base equilibrium of the blood remains unaffected. The beneficial influence of massage following exercise may be due to the carrying away of lactic acid produced on exertion. An increased excretion of nitrogen occurs following massage. There is also an increased output of uric acid, inorganic phosphorus, and sodium chloride. The diuresis which frequently occurs after abdominal massage may be attributed to increased abdominal pressure. The rate of creatinine excretion is not affected.

During or following massage, there is an increase in the red blood cell count, which diminishes slowly. Because of the increase in red blood cells and hemoglobin, the blood has an increased oxygen capacity. Massage aug-

ments the blood flow not only in the skin but also in the muscles. We have observed the latter effect experimentally by means of thermocouple determinations taken before and after massage of the muscles of the calf of the leg. The improvement in tone produced in atrophied muscles may be explained by this factor. The removal of muscle metabolites may be responsible for the rapid restoration of muscle capacity after exercise, for the improvement in circulation occurring in extremities in cardiac decompensation, and for the diminution in the edema of lower extremities that occurs in chronic conditions such as arthritis. The rate of absorption through the lymphatics has also been shown to be increased by massage. The acceleration of lymphatic and blood circulation may account for the increased removal of extravasated lymph and blood from the tissues. Clark and Swenson have shown that light massage of the ear of a rabbit caused dilatation of its capillaries with an increase in the rate of blood flow, and changes in the blood vessel walls indicated by "sticking" of leucocytes and their migration through the wall.

Contrary to popular belief, massage does not directly increase muscle power, nor does it remove fat. When Rosenthal massaged the abdominal walls of animals with sufficient vigor to produce multiple hemorrhages, destructive changes in adipose tissue were not observed. According to Mennell, gradual stretching and massage influences yellow elastic connective tissue, but not white fibrous tissue.

The effect of massage on the nervous system varies in different persons. General body massage usually has a sedative influence. Mennell called attention to the soothing effect of massage on psychically disturbed patients; he attributes this result to the influence of effleurage on the nervous system and on local nerves. Coulter stated that stimulation of a superficial nerve along its course first causes pain and later a reduction of pain, and indicated that this effect might be of value in the treatment of néuralgias of nerves such as the ulnar and supra-orbital. Buchholz found that while massage might cause pain at first, it later tends to cause numbness and so relieve pain. According to Rosenthal the stimulus threshold of the skin is markedly raised after a few minutes of massage, but the sharpness of the localization sense is impaired for about ten minutes. Even though its irritability is reduced, a muscle can be made to contract when its motor nerve is stimulated mechanically. Vigorous and long-continued stimulation causes fatigue of the motor end-plates and sensory receptors. Massage increases the temperature of the skin. It also helps to remove the superficial dead layers and any secretions lying upon them.

TECHNIQUE

There are four variations in the technique of massage *stroking*, *compression*, *percussion*, and "vibration and shaking"

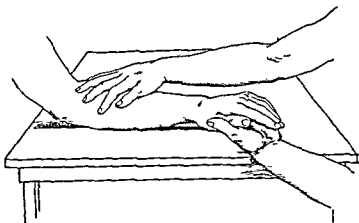

FIG 179 Stroking

STROKING MOVEMENTS

Stroking movements are applied lightly or with pressure. The former is referred to as "superficial" stroking or *effleurage*, the latter, as "deep" stroking or *effleurage*. There is no sharp line of demarcation between the two, many gradations are possible. In light stroking, the physiological objective is essentially a reflex action, with greater pressure, the mechanical factor is also brought into play. To secure an efficient reflex effect, superficial stroking should be, as Mennell states "slow, gentle and rhythmical". Jerky movements are irritating. To exert a soothing influence, the timing of the component parts of the movement must remain the same. The hand should be gradually placed on the treated surface and gradually removed, then cyclically reapplied in similar fashion. To avoid abrupt motion, the surface should be lubricated with powder or a substance such as *albolene* or *cocoa butter*. Because its action is reflex, the movement just described may be applied from or toward the torso. Usually, however, as with other methods of massage, the direction of the stroke is toward the torso. The direction adopted should be followed throughout the application as reversing it is irritating. On the return part of the stroke, the hand may be lifted off the surface of the skin or may remain lightly in contact with it. Whether the palm and the fingers, or the fingers alone, are applied depends on the contour and extent of the treated surface.

The objective of deep stroking massage is mechanical to propel the con

tents of the veins and lymphatics. To accomplish this, the patient's muscles must be relaxed and he must be lying down so as to take advantage of the influence of gravity. Comparatively little pressure is needed to assist in the propulsion of venous blood. Mennell suggests that when the muscles are in a state of relaxation, the limbs should be regarded as a bag containing fluid. The massaging movements are carried toward the torso; the most centrally located parts are massaged first, then the more distal. In deep-stroking in the region of the muscle, the initial pressure, applied to the area of the distal attachment, is gradually increased as the hand approaches the belly of the muscle, and then gradually relaxed over the region of the proximal attachment.

#### COMPRESSION MOVEMENTS

Compression movements comprise kneading, petrissage, and friction. These are applied essentially for their mechanical action in propelling blood and lymph centripetally. In kneading, the pressure is exerted in a circular movement with the flat of the hand. When applied to the back, the part of the muscle treated is compressed between the operator's hand and the skeletal structures; when applied to the calf muscles, between the hands of the operator. After the pressure has been applied to one area, the hand is shifted to the adjacent region, not moved continuously toward the torso as in deep stroking. When the kneading movement is used in abdominal massage, its influence on the intestinal contents is due to a change in intra-abdominal pressure, and to reflex action, rather than to any direct mechanical effect.

In petrissage, the muscle is alternately grasped and squeezed between the thumb and fingers of both hands as they are moved toward the torso. Petrissage may also be applied with one hand. The tissues are grasped between the thumb and fingers as the hand moves along. As in other forms of massage, the muscles must be relaxed and the movement applied in rhythmic fashion (Fig. 180).

Friction is applied with the tips of the fingers, in a small, circular motion. The fingers remain in contact with the skin as it is moved over the underlying tissues. A lubricant is not used as it might cause the fingers to slide over the skin. Friction is used in localized areas in an effort to loosen scars and adhesions and to hasten absorption of effusions (Fig. 181).

#### PERCUSSION MOVEMENTS

Percussion movements are also referred to as "tapotment." They consist of a series of blows applied in rapid succession in forms called hacking, clap-

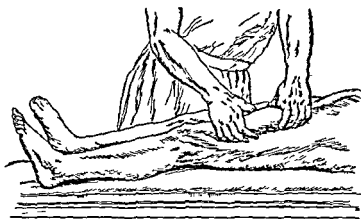

FIG 180 Petrissage

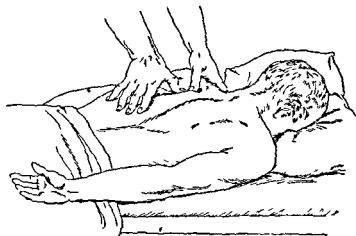

FIG 181 Friction

ping, slapping, tapping, and beating. In hacking, the palms of the operator's hands are held facing each other. The hand is brought down smartly as if it were hinged at the wrist with the ulnar aspect of the little finger first hit-

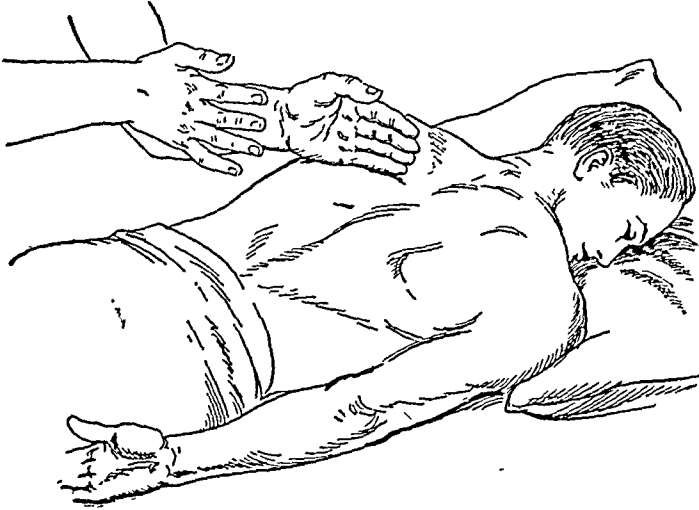

FIG. 182. Tapotement (percussion) movement.

ting the surface of the region massaged. The ring, middle, and index fingers are then brought down rapidly in consecutive fashion. The movement, therefore, consists of a series of blows of one finger upon another as the whole hand is made to come down vigorously (Fig. 182). In clapping, the cupped palms are applied alternately. The movement of the hands is carried out chiefly from the wrist. In slapping, the same type of movement is performed with the open palm of the hand. In tapping, the tips of the fingers are used. In patting, the half-closed fist is used.

#### VIBRATION

In vibration, the fingers are placed on the part, and a vibratory movement conveyed by alternate contraction and relaxation of the muscles of the operator's extremity. A similar and coarser motion is that of "shaking." Vibratory movements can be performed with mechanical devices, which may be applied either directly or through the mediation of the operator's fingers. Some machines cause vibration of a part; others of the entire body.

#### GENERAL CONSIDERATIONS

The room in which the massage is given should be comfortably warm so that the patient is not chilled when the clothing is removed. It is advisable to have some form of heat application precede the massage. If the massage is administered for sedation, there should be no distracting sounds.



The physical factors in the room should be conducive to relaxation. Massage should be applied directly to the skin of the treated region, never through intervening coverings. Both subject and operator should assume positions of greatest relaxation. The massaged part must be supported in order to secure complete relaxation. If a table is used, its height should not require excessive stooping on the part of the operator, the top should be firm but not hard. The operator's hands should be in proper condition, rough horny areas prevent the administration of a proper massage. The patient's clothing should be arranged so that the area proximal to the region massaged is not constricted. Likewise, the operator's clothing should allow of ease of movement, sleeves should not extend below the elbow. At the beginning, massage should be applied lightly and later with increased force. The patient's skin should be prepared with a lubricant. Most operators appear to prefer talcum powder. Cocoa butter, mineral oil, olive oil, vaseline, cold cream are more slippery lubricants which may be useful when the skin is dry. Too much lubrication should be avoided because some degree of friction is necessary for efficient massage. Lubricants should be removed with alcohol at the end of the treatment.

The duration of a treatment should be governed by the condition for which it is given. Usually, in local areas five to fifteen minutes are sufficient. Massage should not be continued so long that it proves tiring to the patient. Nervous persons and the very young and the old do not tolerate massage for as long periods as do vigorous adults. A general body massage requires from three-quarters to one hour. Treatments can be applied daily or every other day.

#### INDICATIONS

Massage is of value in the care of some post traumatic conditions. In sprains with torn ligaments and tenosynovitis, massage facilitates in reducing the swelling due to extravasation of blood and lymph. It also helps to relax muscle spasm. Superficial stroking is applied first, and later, deep stroking and kneading is used in conjunction with heat from a photothermal source or a high frequency machine. During the intervals between treatments the sprained joint can be supported by means of a bandage. Following the reduction of dislocations, massage may be applied as in the care of joint sprains. It is of value in sacro iliac and lumbosacral strains. Thiele suggested massage of the levator ani, coccygeus, and piriformis muscles for the relief of spasm and pain in coccygodynia.

In the care of fractures, too long an interval is usually allowed to elapse

before massage and motion are initiated. Strenuous and carelessly applied massage and motion may cause displacement of the fractured ends of bone. On the other hand, since long immobilization may result in atrophic changes in soft tissue with consequent limitation of motion and even ankylosis, it would appear logical to start very gentle massage relatively early. A bivalved cast permits massage while the part is still immobilized. Mock has presented a table showing the approximate times at which massage and motion may be instituted in various types of fractures. He says that no motion except superficial stroking should be given over the region of the fracture. Evidences of too much massage are increased tenderness, swelling, or stiffness in the adjacent joint.

Massage is of great value in the care of traumatic, inflammatory, and atrophic states of muscle and fibrous tissue. The helpful effect of massage in muscle cramps is recognized by most persons. It is useful in the treatment of torticollis. Myositis and fibrositis are usually speedily improved following the use of massage subsequent to the application of heat. During the acute stage of fibrositis effleurage is applied; the chronic form is treated with petrissage, vigorous friction, and vibration. Heavy stroking and kneading may cause temporary increase in the pain. Fibrositic changes may be responsible for such complaints as "lumbago," torticollis, and headaches. The painful nodular and indurated areas become less tender and frequently the associated muscular spasm is relieved. Occupational muscle spasm such as writer's cramp is usually relieved by massage following the application of heat. So also is the pain in contused muscles; massage applied twenty-four or more hours after an injury is sustained helps to promote absorption of exudate with consequent relief of pain and stiffness. The increased circulation which it produces is of value in the effort to maintain the trophic state in muscles deprived of their nerve supply as a result of trauma. Gentle massage is of value; vigorous massage may increase the damage to the muscle structures.

Limitation of joint motion following a fracture or chronic inflammation is benefited by a combination of heat, massage, exercise, and traction. Massage is an important therapeutic factor in the care of chronic arthritis, both atrophic and hypertrophic. In acute arthritis, it is contraindicated. Pember-ton states that there are three chief indications for massage in the arthritic syndrome: (1) to improve or maintain adequate conditions of circulation and drainage in the region of the joints; (2) to improve or correct the faulty physiological processes in the soft structures; and (3) to partially compen-

sate for the lack of muscle activity. The trophic disturbances which accompany long standing arthritis, such as edema, muscle atrophies, shiny skin, coldness of the hands and feet respond favorably to massage. Following preparation with the whirlpool bath, massage is applied to amputation stumps to keep the scar loose and to prevent contractures.

In disturbances of the cardiovascular system massage can be of value. It exerts a favorable influence on the peripheral vascular bed and on edema of dependent portions of the body. It is also of benefit when vascular stasis occurs in individuals who are bed ridden for long periods of time from causes other than cardiovascular insufficiency. Mild general massage is said to produce a sense of well being in patients with *angina pectoris*, and will relieve the depression due to lack of activity.

The sedative effect of general body massage is utilized in neurasthenia to relax the tenseness arising from mental or emotional strain. Neurological conditions in which massage is of value include hemiplegia and facial paralysis, disseminated sclerosis, paralysis agitans, syringomyelia, and chorea.

When employed for the treatment of constipation massage probably has little effect other than causing a change in intra abdominal pressure and improving the muscle tone. The possibility of causing an orderly progress of the fecal contents by this means is remote. Except for the areas where it is held fixed, the intestine is pushed away when pressure is applied over it. It is believed by some that massage can influence the relatively fixed portions of the large colon, namely, the ascending and descending part. It is also thought that it is possible to break up fecal impactions. Mennell recommended massage following abdominal operations to assist in the expulsion of flatus. He also suggests its use for the treatment of mucous colitis. Sedative massage is applied to the back, together with heat, to relieve bowel spasm.

General massage combined with deep stroking and kneading of the thoracic muscles and percussion over the upper parts of the back in the region of the apexes of the lungs has been recommended for chronic bronchitis.

Massage is utilized during pregnancy to give relief for mild edema of the legs, for backache, for leg cramps, and for nervous headaches. During the postpartum period it is applied for postpartum hemorrhage resulting from subinvolution of the uterus, to assist in expressing the placenta, and to relieve sore abdominal muscles and painful extremities.

In the care of secondary anemia general massage is of limited value. In diabetic patients it may be of use in prevention of gangrene. While massage cannot remove local deposits of fatty tissue, it can help to make flabby skin

more firm after weight has been lost. Its general metabolic influence is also of assistance in the care of overweight individuals. Friction is applied to areas of scar tissue in the effort to induce resorption.

#### CONTRAINDICATIONS

Massage should be avoided in the presence of new growths, both benign and malignant; acute phlebitis and thrombosis; lymphangitis; acute inflammatory conditions of the skin, soft tissues, joints and bones. Diseases of the skin, such as eczema, acne, boils, ulcerations, and wounds, are contraindications. In hyperesthesia, massage should not be given. Pregnancy is a definite contraindication to abdominal massage; so also are inflammatory conditions of the abdominal cavity. It is also contraindicated in acute communicable diseases, advanced nephritis and arteriosclerosis.

#### REFERENCES

- BUCHOLZ, C. H. *Therapeutic Exercise and Massage*. Philadelphia, Lea & Febiger, 1917.
- COULTER, J. S. *Massage*. In G. M. Piersol, *The Cyclopedia of Medicine*. Philadelphia, F. A. Davis, 1933, Vol. 8, pp. 598-617.
- MENNELL, J. B. *Physical Treatment, Massage, etc.* Philadelphia, Blakiston, 1934.
- MOCK, H. *Massage in surgical cases*. In *Handbook of Physical Therapy*. Chicago, American Medical Association, 1939.
- PEMBERTON, R. *Massage in internal medicine*. In *Handbook of Physical Therapy*. Chicago, American Medical Association, 1939.
- ROSENTHAL, C. *Die Massage und ihre wissenschaftliche*. Berlin, Berggrundung, 1910.

## CHAPTER XII

# EXERCISE

**E**XERCISE IS A PHYSIOLOGICAL ACTIVITY OF UNIVERSAL interest. It helps to maintain a state of well being in a person who is healthy, and to afford him recreation. This concept appears to have been accepted in ancient times, as was the one that exercise has remedial value for persons suffering from diverse conditions. Modern ideas on the subject owe their origin to Ling who began his work at the beginning of the nineteenth century. Since that time, numerous schools of thought have developed, their names indicate the nations of their origin. While the basic principles of exercise are generally agreed upon, there still remains considerable diversity of opinion with regard to the methods of application for the treatment of specific conditions. The active thought given to the subject today promises closer agreement of methods in the future. Exercise employed in the treatment of abnormal conditions requires scientific supervision of bodily movement for the specific purpose of restoring normal function.

### PHYSIOLOGY

The body has 434 muscles, which constitute about 45 per cent of the total body weight. Each muscle is an organ, having the power to contract and relax, and so to produce movements at the joints. Rathbone has emphasized the importance of the 'stretch reflex'. An increase in muscle stress causes a corresponding increase in its tension, therefore a muscle held in an elongated position becomes stretched permanently, while one held in a shortened position becomes shortened.

The physiology of exercise has been described by Best and Taylor, McCurdy and Larson, Schneider, and others. Muscle contractions are accompanied by liberation of heat and complex chemical changes. The metabolism of muscles is increased during activity, slight exercise increases it from 20 to 25 per cent, strenuous exercise may increase it ten to twenty times. The greater need for oxygen and the greater elimination of carbon dioxide increases respiratory and cardiac rates. The pulse rate of a trained athlete

quickness but little as compared with that of an untrained person doing the same amount of muscular work. The more severe the exercise the more rapid is the pulse; an increase of from twenty to forty beats per minute is considered normal during moderate exercise. No change in rate occurs during passive exercise unless the patient becomes fatigued or is otherwise disturbed. Jacobson states that the pulse rate decreases during "progressive relaxation." According to Best and Taylor, the blood flow through active muscles is twenty or more times greater than it is when the muscles are at rest. The capillary blood bed becomes enlarged. Arterial and venous blood pressures are raised. The rise in arterial pressure may average between 60 and 70 mm. of mercury; the venous pressure also is augmented by the increased pressure on capillaries, venules, and thin-walled veins resulting from contractions of the muscles. The stroke volume of the heart increases. Dilatation of the blood vessels of the skin admits of increased heat loss from the body; if the heat is not lost rapidly enough, the temperature of the body will rise. Following exercise, the respiratory and cardiovascular mechanisms gradually return to their previous levels after the metabolic demands of the body have been met.

#### PRESCRIPTION FOR EXERCISES

A physical examination helps to determine whether a person may be permitted vigorous exercise or whether his exercise should be limited. A preliminary physical examination is required for all school children. It should likewise be required before exercise is prescribed for adults. There are schools for teaching the direction of exercise to physical educators and physical therapy technicians, and the physician usually relies on a technician so trained for administration of prescribed exercises. Exercise used in the treatment of pathological conditions should be as carefully prescribed as is any other form of treatment. It may be directed toward social and mental rehabilitation or toward correction of functional or structural abnormalities. Its type, duration, and frequency should be adapted to the patient's needs. Exercises which require speed in their performance may be indulged in up to the age of about thirty-five years; those requiring strength should be limited to the years between sixteen and forty; those requiring endurance are better suited to persons between youth and middle-age. It is generally agreed that controlled exercise is as valuable for women as it is for men. The dangers in the use of exercise are discussed on page 436.

TABLE III

## A CLASSIFICATION OF THERAPEUTIC EXERCISES

Local		
A	Local corrective	B Re-educational
1	Passive	1 Co-ordination
	(a) Relaxed	2 Relaxation
	(b) Forced	3 Inhibition
2	Assistive	4 Rhythmic
3	Active	5 Hydrogymnastic
	(a) Static	
	(b) Free	
4	Resistive	
	(a) Concentric	
	(b) Eccentric	
5	Hydrogymnastic	
6	Apparatus	
	(a) Medical	
		C Occupational
		1 Major crafts
		(a) Weaving
		(b) Woodwork
		(c) Metalwork
		(d) Basketry
		2 Minor crafts
		(a) Needlework
		(b) Beadwork
		(c) Cord knotting
		(d) Block-printing
General		
D	General corrective	E Recreational
1	Strengthening	1 Passive
	(a) Symmetrical	(a) Entertainments
	(b) Asymmetrical	(b) Concerts
2	Stretching	(c) Radio
	(a) Creeping	(d) Motion pictures
	(b) Hanging	
	(c) Traction	2 Active
3	Postural	(a) Gymnastic apparatus
	(a) Lying	(b) Rifle shooting
	(b) Sitting	(c) Swimming (pool)
	(c) Standing	(d) Occupational therapy
4	Respiratory	(e) Games
	(a) Inhalation	(1) Low organization
	(b) Exhalation	(2) Medium organization
5	Calisthenic	(3) High organization
6	Apparatus	
	(a) Gymnastic	
7	Hydrogymnastic	
8	Circulatory	

## CLASSIFICATION OF EXERCISES

It is difficult to formulate a satisfactory classification of exercises because of the differences in terminology used to describe various movements. Wiechec groups exercises under the following headings:

1. Description of action, e.g., passive, active, resistive, and so forth.
2. Apparatus, e.g., table, mat, bar, and so forth.
3. Diseases from which exercises have been named, e.g., obesity, spastic, tabes, and so forth.
4. Exercises named for individuals, e.g., Schott, Buerger, and so forth.
5. According to country, e.g., Swedish, Danish, and so forth.
6. According to field of medicine, e.g., obstetrics, orthopedics, physical therapy, and so forth.

The table on page 333 formulated by Wiechec gives a useful classification.

*Passive movement* is exercise carried out by the operator without the assistance or resistance of the patient. The term "relaxed movement" has been applied by Mennell to this type of exercise (Fig. 183). To obtain relaxation the part should be supported so that the patient will have a sense of security. The movements must be made gently and within the limits of motion which may cause pain or spasm. Passive movement is employed to prevent atrophic changes in muscles, fibrous tissue, bones, and about joints. It helps to prevent adhesions between muscle planes and to hasten restoration of function. It is not used in acute inflammatory conditions or where there is bony fusion.

*Active movement* is exercise carried out by the patient himself. There are three types, which are referred to as "free," "assistive," and "resistive." When free movements are to be performed the influence of gravity should be reduced as much as possible to minimize resistance. This may be accomplished by immersion of the part in water (as in tanks and pools), by slings, or with smooth boards whose surfaces are powdered to diminish friction (Fig. 184). Assistive movements are performed actively by the patient, aided by the operator or by gravity or by some outside force, for example, a weight and pulley. Their object is to permit the patient to accomplish more than he could unassisted. Assistive exercises can be used as a preliminary to free movement. Restoration of the part to normal is hastened when resistive movements can be applied. The exercises are made more severe by the resistance offered by the operator, by gravity, or by weights and apparatus.

Another form of exercise which may be called "active," but in which no joint motion occurs is that termed "muscle setting." It can be carried out





FIG 183 Technique of passive motion at the shoulder joint Operator supports weight of arm with one hand The other hand is held on the shoulder to prevent any movement other than that of the shoulder joint Assistive motion is applied in the same manner while the patient himself moves the arm as far as he can

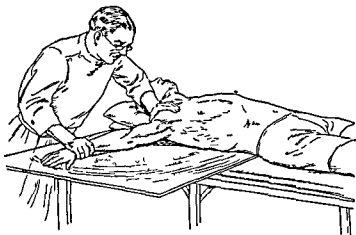

FIG 184 Passive movement on a powdered board

while the limb is held fixed in a splint. Alternate contraction and relaxation of the muscles is performed without any motion. Such exercise is sometimes of value in maintaining muscle strength during the period when motion is not permissible.

MUSCLE RE-EDUCATION

Re-education of muscles is carried out to strengthen these structures when they are weak or when there is disturbance in co-ordination between the neural and muscular apparatus. Re-establishment of the pattern of motion within the brain is an important part of this training. Use is made of passive motion as well as of assistive, free, and active motion in re-education procedures. Voluntary active motion is the most effective, and should be emphasized. As the character of the motion prescribed must be adapted to the severity of the neuromuscular disturbance or weakness which is present, a preliminary test should be made to determine the strength and weakness of muscles. This will serve to indicate the character of the exercise which should be given, and also as a basis for the proper record. The test should be repeated at regular intervals and the progress noted (Figs. 185, 186, 187). The following is a classification of muscle strength, devised by Lovett:

Complete paralysis	. . . . .	No activity in muscle
Trace	. . . . .	Slight contraction noticeable, but no un-assistive movement can be performed
Poor	. . . . .	Muscle contraction will cause movement if gravity is eliminated (free motion)
Fair	. . . . .	Muscle can overcome gravity
Good	. . . . .	Muscle works against gravity and some resistance
Normal	. . . . .	Muscle has its full power of contraction

According to Mennell, the principles which should be kept in mind in re-education of muscles are:

A weak muscle cannot contract unless its antagonist relaxes in conformity. The first thing therefore is to teach the antagonist to relax.

Make sure the patient understands what he is expected to do. If only one side is involved, perform movement on the normal side first.

Do not ask the patient to perform a motion unless there are reasons to believe that he can do so. For example, do not ask a muscle classified as "poor" to perform a motion against gravity. If we do, the result will probably be that the synergistic contract vigorously but that the weak muscle does not even attempt to contract.

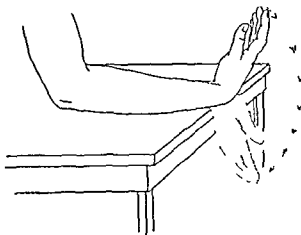

FIG 185 Assistive motion of wrist with gravity aiding

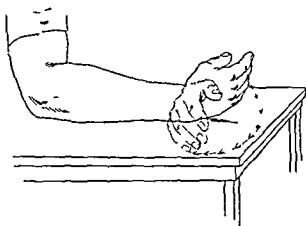

FIG 186 Free motion of wrist with gravity eliminated Hand moves on smooth surface

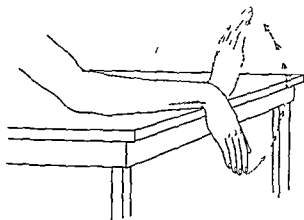

FIG 187 Resistive motion of wrist against gravity

Graduate activity.

Whenever possible, start with *natural* movement.

Alternate rest and activity.

Range of movement considered. A muscle may have the potential power to contract throughout the whole range of motion, but may not be able to do so at once.

Never overstretch a weak muscle. After treatment, place the part in "anatomical rest position."

Many of these principles are similar to those advocated by Sister Kenny for the treatment of poliomyelitis.

### MOBILIZATION AFTER INJURIES

The time at which active motion may be most advantageously instituted after a period of immobilization is discussed in the chapter on diseases of the locomotor system (Chapter XVI). Early mobilization has as its objective restoration of function as completely and as speedily as possible. Its purpose is prevention of muscle atrophy, and preservation of muscle elasticity and contractility. In order to assure proper healing of a fracture or injury, the injured part must often be immobilized in a position in which one muscle group is stretched while the origin and insertion of the opposing muscle group are approximated. This may result in a contracture, the severity of which will correspond to the time of immobilization.

#### FINGER JOINT

To regain mobility of fingers, the patient should make all the motions of each joint separately, and then all the joints together (flexion, extension, abduction, and adduction, and opposition of the thumb). When one joint is to be exercised, the fingers should be held by the operator or the patient, himself, in such a manner that the motion takes place mainly in the joint being exercised.

#### WRIST JOINT

During the immobilization period, fingers, elbow, and shoulder joint should be exercised regularly. When active motion is to be started, the forearm should rest on its ulnar side on a table or on a board, powdered to eliminate friction. The assistant should hold the forearm fixed to prevent motion at the elbow. The patient is then asked to flex and extend his wrist joint without motion of the fingers. This procedure is repeated several times daily. When pain on motion has almost disappeared, pronation and supina-

tion may be begun, and also wrist flexion and extension with and against gravity. Motion should be carried only to the point of tolerance, increased pain after exercise is a sign that the motion has been too strenuous.

#### ELBOW JOINT

Active motion is started with the arm and forearm resting at a right angle on a powdered board or immersed in water.

#### SHOULDER JOINT

If the patient can do so, he is told to sit on a stool and bend toward the injured side. With his arm hanging relaxed, he can then start little pendulum swinging motions with a minimum of muscular effort. When it can be done *without pain*, *circumduction* may be started in the same position, and one can gradually progress to motions with and against gravity.

If the patient is unable to sit up, a powdered board may be placed under the injured arm on the bed, and the patient instructed to abduct his arm to as great a distance as he can tolerate. Or, he can lie prone, let the arm hang over the side of the bed, and swing it loosely as described above. After a few days he can lie on his unaffected side and abduct his arm. When he is able to do so, he should try to lift his arm forward and upward, assistance may be given at first if necessary. Then, lying supine, he can start external and internal rotation. With the forearm at right angles to the arm, and the elbow resting on the bed, the forearm is moved forward and backward to the *limit of tolerance*.

Various mechanical devices are available to encourage motion of the joints of the upper extremity. These include such apparatus as the shoulder wheel, stall bars and shoulder ladder, and the special table for exercises requiring the use of the hand, wrist, and forearm. Plans for the construction of these devices can be secured from the Council on Physical Therapy of the American Medical Association. Other devices are pulleys and weights such as are commonly found in gymnasias, and occupational therapy machines, which are described in Chapter XIII. Zander developed many complicated machines for moving parts of the body, which are in use in European spas, but not generally employed in this country.

#### HIP JOINT

Motion of the hip joint may be started with *loose swinging of the leg* as illustrated in Figure 197. If the patient cannot sit up, he can lie on his unaffected side, and *move his leg forward and backward*, with assistance, at

first, if necessary. Abduction is practiced lying on the back; the leg is moved sideways and then brought back to the initial position. External and internal rotation is also begun in the supine position. After a few days, hip flexion

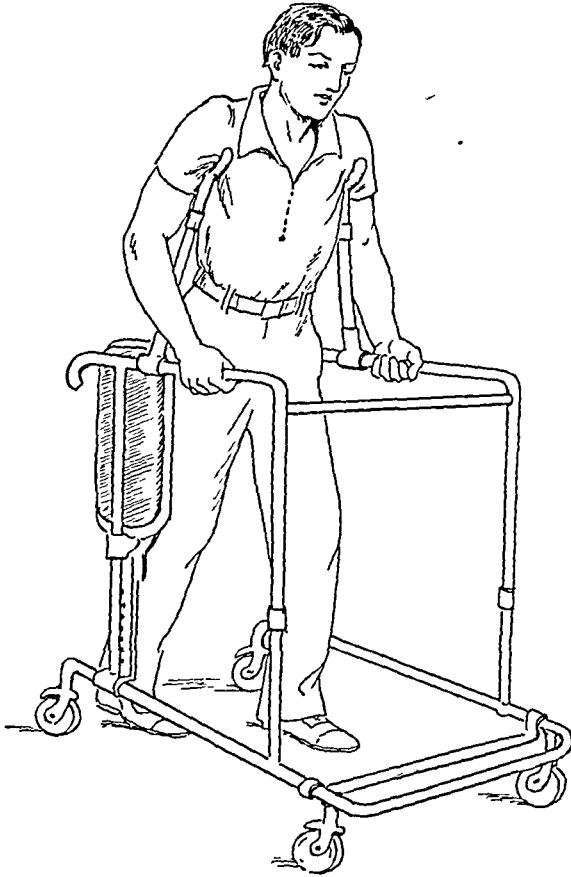

FIG. 188. Patient in walking machine.

can be combined with knee flexion, at first without, and later against gravity. Finally, weight-bearing is permitted with administration of walking exercises.

Mechanical devices are available to aid in restoration of motion in the lower extremities. While the patient is still in bed an apparatus such as that suggested by Gaenslen can be used. This consists of a sling suspension and a shoe, to the heel of which a roller is attached. Roller skate wheels or a metal ball surrounded by ball bearings will serve as a roller. A firm thin board placed on the bed facilitates the use of this rolling mechanism. The patient grasps a handle which is attached to a cord that is passed through an overhead pulley and then brought down under the knee. When the cord is pulled, the knee and hip are caused to flex. With this sort of arrangement, passive and assistive abduction and adduction of the hip is also possible.

Stationary bicycles and occupational therapy apparatus such as foot powered sewing machines, are additional mechanical aids. When weight bearing is permitted, a "walker" helps to shorten the interval required before the patient can stand on his feet unaided and begin to do walking exercises. Good "walking machines" are available or one can be constructed in accordance with plans which can be secured from the Council on Physical Therapy of the American Medical Association (Fig. 188).

#### KNEE JOINT

During immobilization, the patient is encouraged to exercise the quadriceps by static contraction and relaxation and to practice dorsiflexion of the ankle. Active motion of the knee is started with the patient lying on his unaffected side, either in water or with the leg resting on a board. The thigh is held by an assistant in order to prevent hip motion. Later on, the patient may sit with his leg hanging over the edge of the bed, and swing his knee loosely forward and backward. When additional mobilization is required, assistive motion is performed with the patient in this position. If the extensors are weak, the patient may lie prone, and flex his knee as far as possible, in order to secure the aid of gravity in extending the knee. Gravity can also be made use of when there is difficulty in flexing the knee. For this, the patient lies supine with the hip flexed. As improvement continues, weight bearing exercises are permitted. These include walking, slight knee bending in the standing position, and later, bouncing (Figs. 206, 196, 198).

#### ANKLE JOINT

Motion of the toes should be started immediately after immobilization. Ankle motion is begun with active inversion and eversion of the foot and dorsiflexion and plantar flexion while the patient lies on his side. When the dorsiflexors are weak, they should be exercised with the patient lying prone and the knee held flexed. Plantar flexion can be practiced with the patient either supine or with his legs hanging over the edge of the bed.

#### POSTURE

Good posture may be defined as the maintenance of the proper relationship of the parts of the body to each other in different positions. With good posture there is a balanced alignment of the body without undue muscle tension or strain, little muscular effort is needed to balance the weights of the body, and a minimum of muscle action is required to maintain static

as well as dynamic position. The purpose of exercise is to train muscles or groups of muscles to perform the functions for which they are anatomically and physiologically intended with the least effort and the greatest efficiency,

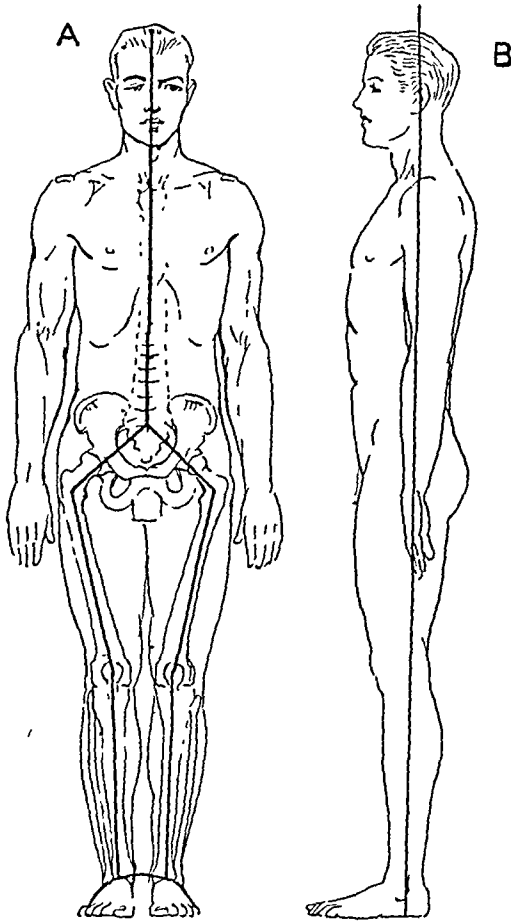

FIG. 189. Proper posture. *A.* Anterior aspect of the body showing well-balanced postural alignment. *B.* Lateral aspect showing the line of gravity.

and to establish new postural reflexes so that proper posture is maintained unconsciously.

In order to recognize and correct poor posture, a knowledge of a few of the fundamentals of weight-bearing is necessary. When the body is held in a proper position, there is an equal distribution of weight on both feet. Anteriorly, a plumb line dropped from the tip of the nose will bisect the body (Fig. 189). Laterally, a plumb line dropped from the lobe of the ear will fall through the center of the shoulder, hip, knee, and ankle. An x-ray of the lateral view of an erect person would show this line passing from the mastoid process, behind the cervical spine, anterior to the dorsal spine, pos-



terior to the lumbar spine, through the knee and ankle joints, and in front of the astragalus. The center of gravity is the point at which the anterior and lateral lines of gravity intersect, that is, in front of the fourth lumbar vertebra.

During movement a change occurs in body weights, with a consequent change in the relationship of the different parts of the body to one another. The purpose of posture education is to teach the subject to perform a movement with the minimum amount of muscular energy and to maintain the proper alignment of the body simultaneously. To achieve this, training in balance, coordination, and rhythm of movement is necessary. Muscle activity causes change or maintenance of a position. If the muscle pulls are equal, the parts of the body will remain in their normal structural alignment. But if the pulls are unequal, because the muscles are too tense or too relaxed, the body will deviate from its natural alignment, and, in order to maintain balance, more and more muscle groups will come into action. The result is an increase in the number of nerve impulses and in residual muscle tension. Discomfort can occur from continuously faulty weight bearing. Pain results from stresses in certain areas, as, for instance, the lower back.

The first step in posture training is, therefore, to compensate between the muscle groups which are too tense and those with too little tonus. This can be accomplished by

- 1 Conscious relaxation of certain muscle groups
- 2 Conscious contraction of muscle groups. Contraction of one muscle group requires relaxation of other muscle groups. An example of faulty muscle action frequently occurs when a patient is asked to raise his arm forward and upward. In doing so, he not only contracts his deltoid but raises his shoulder by means of his trapezius. He should learn to contract his deltoid while permitting his upper trapezius muscle to relax until the arm is elevated to shoulder level.
- 3 Rhythmically changing contraction and relaxation of antagonists. For instance, in a pendulum swinging motion of the arm, the pulls of the contracted pectorals and the too relaxed shoulder adductors are equalized.

Which of these three methods of postural training is to be applied or how they are to be combined depends on the status of the individual patient.

Hand in hand with the equalizing of muscle pulls goes development of "body sense." The patient should be made conscious of the different parts of the body, so that he will be able to sense the relationships of the parts to the body as a whole. Appreciation of these relationships enables him to feel almost instinctively whether or not his stance is correct.

When standing properly, the feet should be parallel and slightly apart. Ankle, knee, and hip joint should be one above the other. To assure proper weight-bearing on the feet, the thighs should be straight and not rotated. Correct inclination of the pelvis is of greatest importance in balanced alignment; if the tonus of the abdominal and gluteal muscles is normal the suprapelvic structures will be well balanced, the position of the pelvis will be correct, and the lumbar vertebrae will assume their normal alignment. The thorax should be relaxed, not pulled up, because the muscles which are used for this purpose also serve as auxiliary breathing muscles. If these must hold up the rib cage, in addition, added effort will be required in breathing. The head should be carried loosely without strain on the sternocleidomastoid muscle or without tightness of the upper trapezius.

The position of the shoulder girdle is determined by the following factors: (1) balance of head and rib-cage; (2) normal muscle tonus of the pectorals in front, and the rhomboids and trapezius in back; (3) equalized muscle pulls of the arm.

When head, rib-cage, and arms are properly disposed in relation to each other, the shoulder girdle will be in a correct position; no one muscle group will be under constant tension, and the natural curves of the dorsal and cervical spine will not be disturbed.

#### METHODS FOR THE DEVELOPMENT OF POSTURAL SENSE

The complex relationship of the various parts of the body to one another in correct posture requires a period of training for its proper understanding. It is simplest to begin to teach the patient while he is in the lying position and then to progress to the sitting, kneeling, and finally the standing position.

In the lying position, the patient can be given an understanding of the proper alignment of his spine. For instance, by flexing the legs actively or passively on the trunk, he will become aware of motion in the lumbar spine. By tilting the head backward and forward he will sense the relationship of the head to the spine. By tilting the pelvis, he will come to realize the relationship between the pelvis and the spine. While lying prone and breathing deeply, the patient will sense a diminution of his spinal curves (Fig. 190); the lumbar spine becomes less concave and the convex dorsal spine elongates, and the pulls of the muscles along the spine tend to become equalized.

After the patient has learned to sense the alignment of his trunk in the lying position, he should attempt exercises in other positions. Figure 191 shows the maintenance of alignment as the subject assumes the sitting position; Figure 192, the alignment as the body is raised from a position in which

the subject lies prone and bent over the end of a bench (Fig 192) An exercise to teach proper body alignment in the sitting position, consists in crossing the legs (Fig 199) while the trunk is relaxed forward and then restored

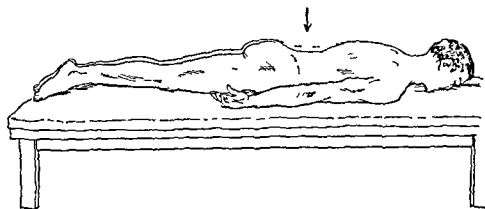

FIG 190 Breathing while lying prone Alteration of spinal curve

to its original position, the back is straightened progressively starting with its lowermost portion, the head being brought back last The same exercise is then practiced in the kneeling and finally in the standing positions For the kneeling exercise the patient sits back on his heels, bends the trunk forward and relaxes as completely as possible (Fig 193) He then straightens up, first with his thighs, followed by the lowest part of his spine, and gradually the rest of his back, with the head last The arms should hang loosely throughout this exercise The same exercise is then practiced in the standing position The trunk is relaxed forward with the arms hanging loosely The patient then straightens his body beginning from his lumbar spine (Fig 194) When this exercise is performed in the kneeling position, the region below the knee is held fixed, whereas in standing, proper alignment of the entire lower extremity as well as of the trunk is required

To obtain proper weight bearing on the feet, the patient should stand with feet parallel and slightly apart The body weight is then shifted alternately forward toward the toes, and backward toward the heels (Fig 195) The body is kept in its natural alignment, the only movement is a swaying motion of the body on the feet, which is gradually diminished, until the patient feels he has found the position in which the least muscle effort is required to maintain balance This exercise, and correction of the position of the ankle, knee and hip joints will help in acquiring a sense of the proper relationship between the legs and the pelvis Also useful for the same purpose is the deep knee bend, if it is executed correctly (Fig 196) The patient stands with feet straight, slightly apart, arms hanging loosely He rises on

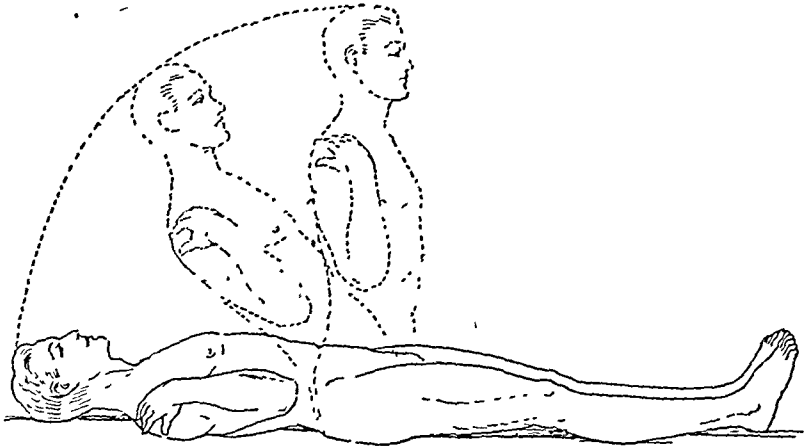

FIG. 191. Exercise for abdominal muscles and for alignment of trunk. Sitting up from lying position with trunk relaxed. Patient lies supine with arms flexed and hands touching shoulders. The trunk is raised slowly to sitting position (indicated by dotted line). Head is kept in line with body.

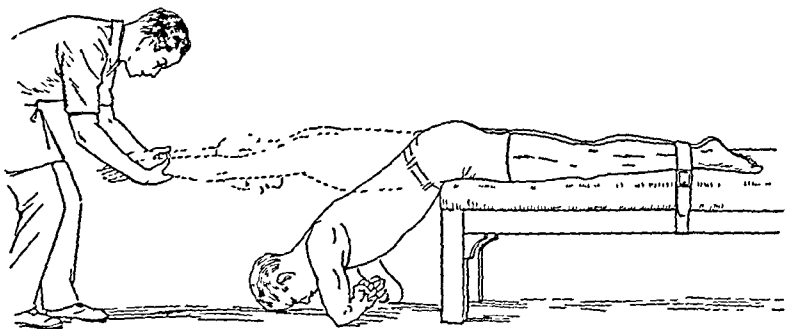

FIG. 192. Exercise for extensor muscles of back and for alignment of back. Patient lying on bench bends over edge at iliac crest. Ankles strapped down. Patient extends arms over head, stretching forward as far as possible toward instructor's feet. Patient then raises trunk keeping arms in line with back and at side of head. Instructor grasps arms above wrist and pulls gently. Patient relaxes trunk and returns to starting position.

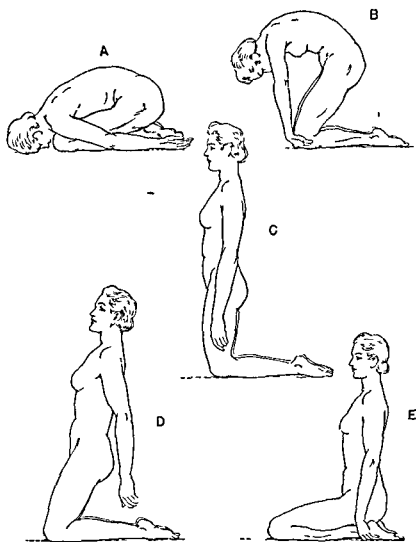

FIG 193 Postural exercise *A* Initial position with knees and hips flexed, trunk forward and relaxed Forehead touching floor Buttocks against heels Arms relaxed and at the side *B* Gradual elevation from the knees while head, arms and back are held relaxed As the legs assume the vertical position the back is straightened beginning first in the lumbar region The head is raised last The arms are held relaxed all the while *C* Body in straight position *D* Subject begins to sit back on heels leaning back with body aligned as long as possible *E* Seated on heels From this attitude, subject relaxes forward into starting position

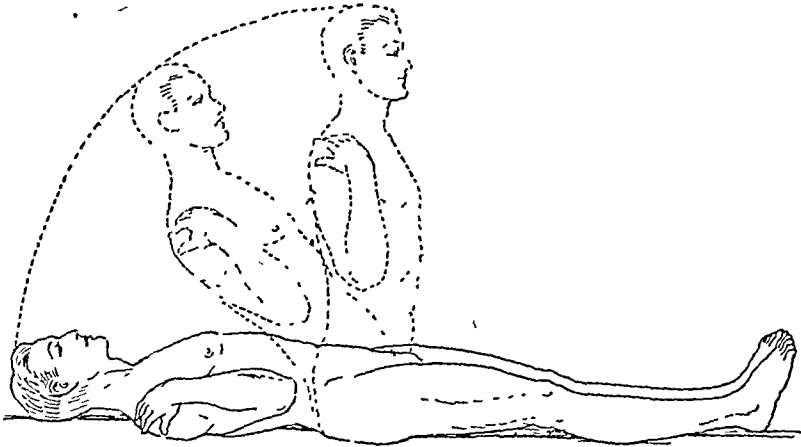

FIG. 191. Exercise for abdominal muscles and for alignment of trunk. Sitting up from lying position with trunk relaxed. Patient lies supine with arms flexed and hands touching shoulders. The trunk is raised slowly to sitting position (indicated by dotted line). Head is kept in line with body.

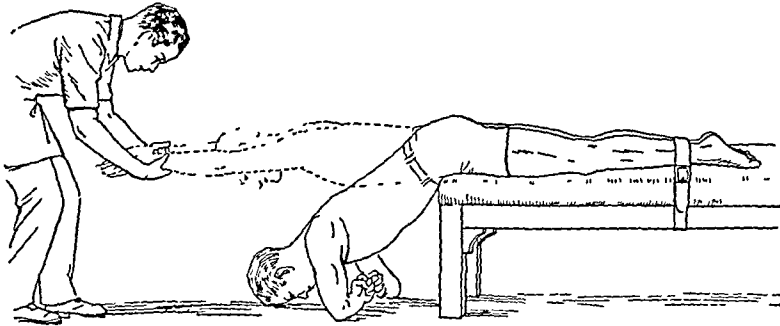

FIG. 192. Exercise for extensor muscles of back and for alignment of back. Patient lying on bench bends over edge at iliac crest. Ankles strapped down. Patient extends arms over head, stretching forward as far as possible toward instructor's feet. Patient then raises trunk keeping arms in line with back and at side of head. Instructor grasps arms above wrist and pulls gently. Patient relaxes trunk and returns to starting position.

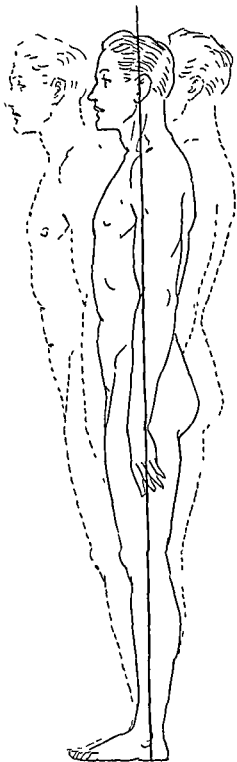

FIG 195 Finding the correct posture by shifting weight forward and backward while keeping body aligned

his toes. He is then told to imagine that pressure is being exerted on the top of his head and that his knee joints are the only places at which he can yield to this pressure from above. The knees should be flexed fully; the back

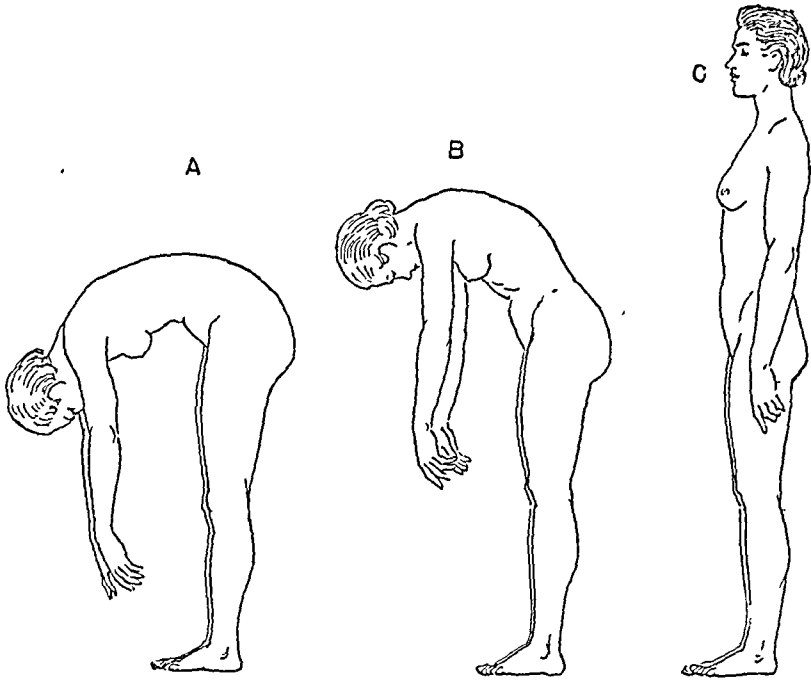

FIG. 194 Postural exercise *A*. Trunk is relaxed forward. Head and arms hang loosely. *B*. Patient begins to straighten upward slowly from lowest part of the spine. Head comes up last. Arms hang loosely. *C*. Body well aligned.

kept in its natural alignment; the arms should hang loosely, or be held forward at shoulder level if the patient has difficulty in maintaining his balance. When rising, the patient should have the feeling of pushing upward the imaginary weight on his head until his legs are straight. The heels are then lowered.

Loose swinging of one leg at the hip joint helps to equalize muscle pulls of the leg. The patient stands with one foot on an elevated platform (Fig. 197). If his balance is poor, he can hold on to an assistant, to a rail, or to a stall bar. The other leg hangs completely relaxed. Later on, he should practice this motion while standing on the floor, and without assistance. For greater variation, this exercise can be done as follows: Swing the right leg forward, backward, forward and place the right foot on the floor. Transfer the weight to the right foot, and at the same time lift the left foot off the floor and continue in similar manner.

To improve co-ordination of the movements occurring between the pelvis,



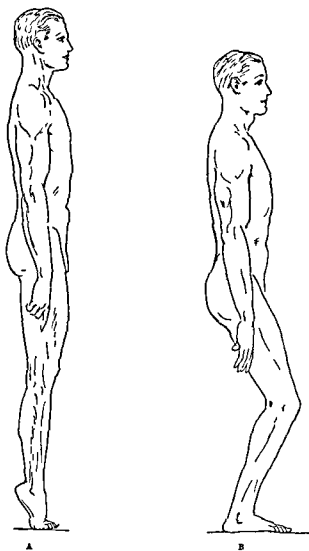

FIG 198 Bouncing *A* Subject rises on toes keeping body aligned *B* He lowers heels and yields to weight of body at ankle, knee and hip joints Rest of body remains aligned

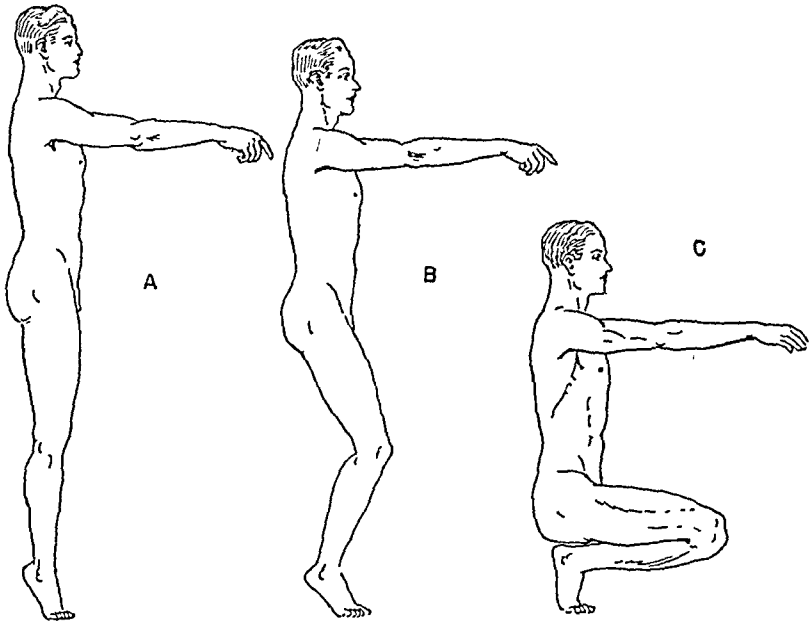

FIG. 196. Deep-knee bending. *A.* Subject rises on toes and elevates arms forward to shoulder level. *B.* Flexion is started. Care is taken to avoid forward inclination of the body. *C.* Flexion completed.

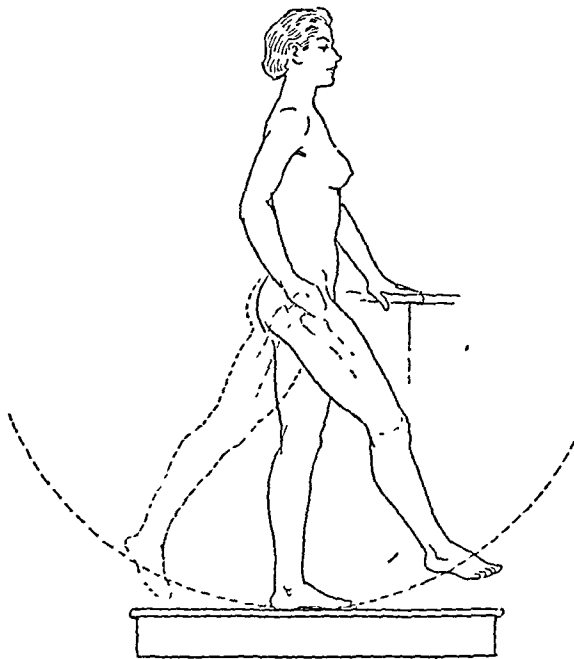

FIG. 197. Pendulum swinging of leg. Patient stands with one foot elevated supporting herself with one hand. Pendulum swinging of leg without shifting body weight either forward or backward.

hip, knee, and ankle joints, the patient is given a bouncing exercise. He bends his knees slightly, yielding to his body weight, while keeping the heels on the ground, then rises quickly on his toes, extending his legs fully. The exercise is then repeated. The back should remain straight, with the arms hanging loosely (Fig. 198).

The correct position of the head can be found by relaxing the head backward, then bringing it upward with a stretching motion of the spine and the back of the neck (Fig. 199). It is advisable to practice this exercise in a sitting position at first. Later on, it should be practiced in the standing position also.

When the muscle pulls of the upper extremities are equalized the arms will hang in their natural position. To acquire a feeling for the proper position of the arms, they should be swung forward and backward, gradually coming to a stop when the subject feels that he has found the right point (Fig. 200). If the pectorals are contracted, and the shoulder adductors are weak, the arms should be swung from side to side in order to compensate between the muscle groups which are too tense and those which are too relaxed (Fig. 201).

*Relaxation* A muscle has the ability to relax, as well as to contract. There is a minimum amount of tension in a muscle (even when it is at rest) which is referred to as "tonus." Dr. Jacobson calls it "residual tension." Persons who are too tense to attain a state of physical and mental relaxation may be taught to reduce this residual tension.

There are various ways of inducing relaxation. One is to require the patient to concentrate on the relaxation of certain muscle groups until he learns to relax consciously. Dr. Jacobson calls his method "progressive relaxation," and describes it as follows:

1. Patient relaxes a muscle group, for instance the biceps brachialis, further and further each minute.
2. He learns to relax consecutively the principle muscle groups of his body.
3. Through daily practice he progresses toward a habit of repose, and tends toward a state in which quiet is automatically retained.

Another approach to relaxation is to change the center of gravity of the body or part of the body. For instance, when a person leans toward one side, allowing one arm to hang loose, the arm will attain a state of relaxation. When he lies down, the body weight is distributed over a much larger area than when he is standing up. Thus, muscle tension is reduced greatly and general relaxation is obtained. Concentration on breathing exercises will also help in achieving relaxation.

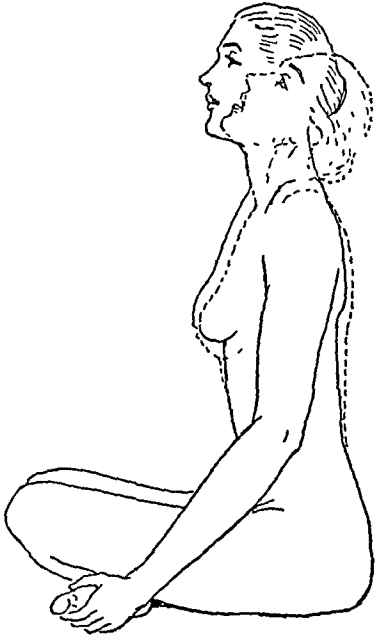

FIG. 199. Postural exercise. Subject relaxes head backward. She then stretches head upward from back of neck.

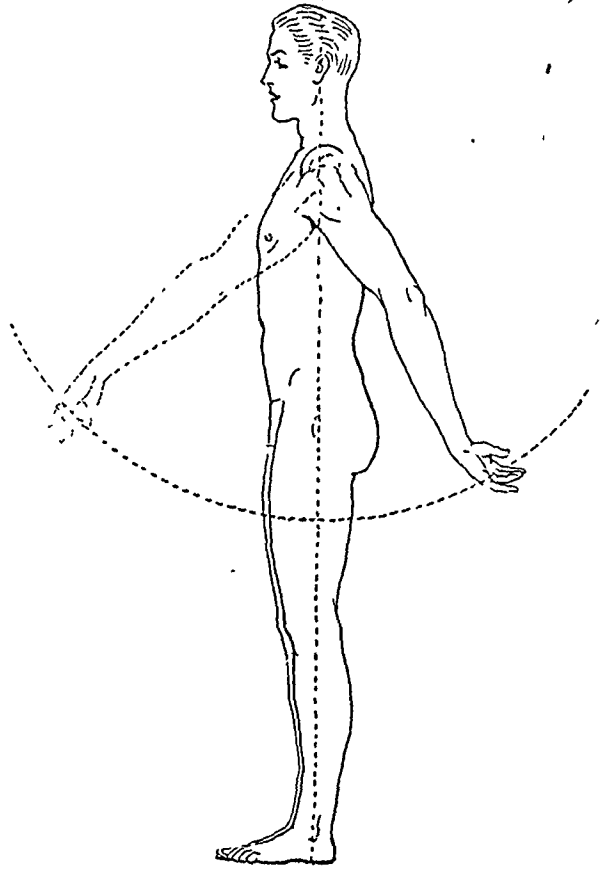

FIG. 200. Relaxed pendulum swing of arm, gradually decreased until arm comes to a stop at its resting point.

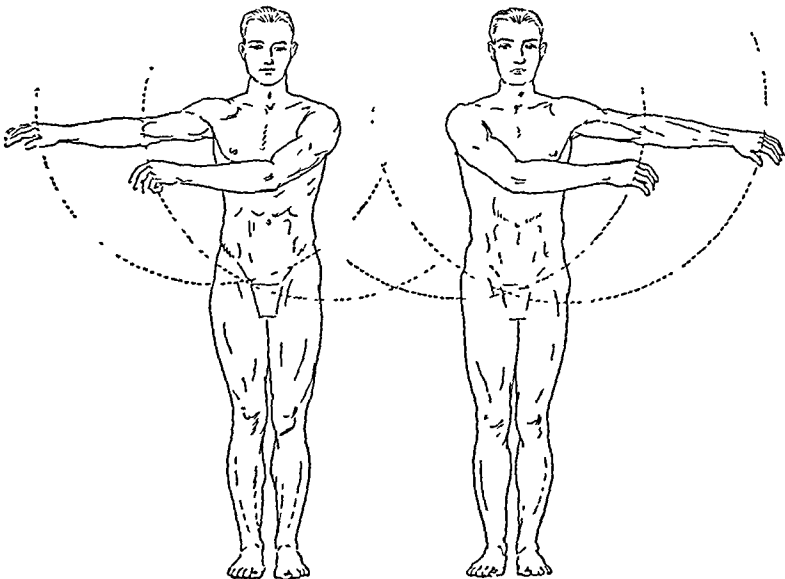

FIG. 201. Loose pendulum swinging of arms laterally.

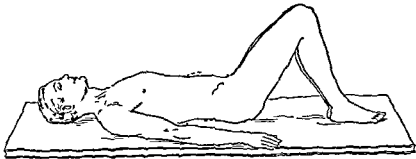

FIG. 202 Abdominal breathing Patient lies supine with legs flexed feet resting on floor Note flattening of lumbar spine during inhalation

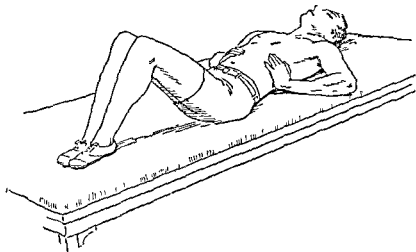

FIG. 203 Costal breathing exercise Patient lies supine with knees flexed and feet resting on table hands placed laterally on lower ribs Wrist and elbows on table Shoulders relaxed During inhalation, effort is made to expand against slight pressure of hands In exhalation hands exert increasing pressure

*Breathing.* Breathing plays an important part in exercise. Its purposeful direction is of therapeutic value. A detailed discussion of the mechanism of breathing is, however, beyond the scope of this volume, and therefore we shall consider only a few of its more important aspects.

Before beginning posture exercises, it may be of value for the subject to close one nostril by holding the forefinger against it and to inhale through the other nostril. On exhalation, this process is reversed. During alternate respirations the pressure against the nostrils is reversed. This will help clear the air passages.

Inhalation through the nose utilizes the air-conditioning ability of the upper respiratory tract. Breath should be exhaled through the mouth. Breathing is referred to as either "abdominal" or "costal," depending on whether the abdominal or costal muscles predominate in its performance. Unless there is a condition to be corrected which requires the specific use of one or the other of these methods, the patient should be permitted to breathe in whatever manner is natural for him. During the performance of all exercises, attention must be given to proper breathing. This is especially true in exercises for the abdominal muscles. As an untrained person is inclined to hold his breath while performing a strenuous exercise, a patient should be instructed to inhale while at rest and to exhale while performing a movement. For instance when sitting up from a lying position, he should inhale first, and exhale as he sits up; he should inhale again while sitting and exhale as he lies down. When the tonus of the abdominal muscles has improved, exhalation should take place when sitting up, inhalation while returning to the supine position.

The process of breathing may be divided into three phases: inhalation, exhalation, and a pause before a new breath is taken. This cycle is referred to as the "breathing rhythm." When teaching breathing or relaxation (the two are closely related) a patient should be allowed to find his own rhythm of breathing; he should be permitted to inhale, to exhale, and to pause without the giving of any commands. This is of great help in inducing general relaxation. Respiratory movements should be as relaxed as possible. Only muscles should be used which take actual part in respiration, or are employed as auxiliary breathing muscles. When told to "breathe in deeply," most persons will elevate the shoulders and contract the sternocleidomastoid muscles; both these muscle groups should be completely inactive during breathing.

Abdominal breathing is taught in the supine position, with knees bent and feet resting on the floor (Fig. 202). This position permits greatest relaxation of the abdominal muscles. The patient should exhale first, inhale

kypholordosis is usually the result of an attempt on the part of the body to rebalance weights which have been unbalanced by changes in some other part of the body. This can occur, for example, when the feet are everted or when

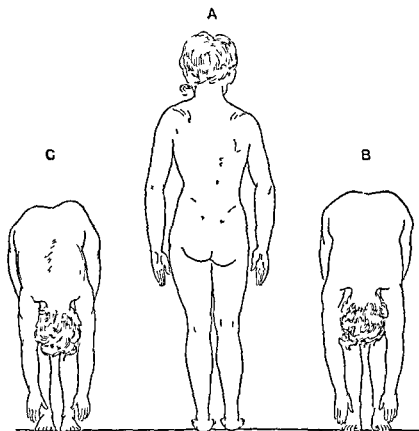

FIG 204 Illustrating the difference between functional and structural scoliosis. A Subject with scoliosis shows elevated left shoulder and left hip. Spinous processes are marked with flesh pencils. If the scoliosis is functional, bending forward as in B causes disappearance of the lateral deviation of the spine. If it is structural as in C forward bending does not cause the scoliosis to disappear.

there is too much inclination of the pelvis. To correct exaggerated anteroposterior spinal curvatures, the body weights must be rebalanced from the feet up, and at the same time the patient must be trained in relaxation, coordination, and equilibrium. In functional kyphosis, the dorsal rotundity disappears when the patient stretches upward with arms extended over the head and the pelvis held fixed (as in sitting with legs crossed), in structural kyphosis, it remains unchanged. Structural kyphosis is usually associated with an exaggerated lordosis. In such cases an effort should then be made to induce good body mechanics, when properly aligned, the body, of itself, will compensate for the increased curvatures.

Juvenile rounded back, or epiphysitis, occurs in children during puberty

while raising the abdominal wall, then exhale again while allowing the abdominal wall to relax. In the beginning, this is repeated three times and is followed by a rest period long enough for at least three normal respiratory cycles. If difficulty is experienced in co-ordinating inhalation and elevation of the abdomen, the operator or the patient himself should exert pressure against the abdomen with one hand, releasing it during inspiration and increasing it during exhalation.

Costal breathing is started with pressure exerted against the ribs by the operator or by the patient himself (Fig. 203). The patient should be encouraged to attempt lateral expansion of the ribs during inhalation and to press against them during exhalation. The same maneuver can be practiced in the standing position. Care should be taken that the shoulders are not elevated during inhalation. In children who have a tendency toward funnel chest or who show a lack of lateral expansion, the operator should press on the chest in the region of the costal angle. In scoliosis, when rotation has taken place and the chest is hollow on one side and elevated on the other, the operator should press against the convex side with his hand. This encourages the patient to make a greater inhalatory effort on the concave side.

A breathing exercise of value, particularly for patients with increased lumbar lordosis or with a rigid lumbar curve, is one which requires the patient to lie prone and to concentrate on breathing in the lumbar area (Fig. 190). A slight elevation of the lumbar spine can be observed during inhalation together with a slight flattening out of the dorsal curve. The "pushing out" of the abdomen should be prevented as much as possible during this exercise.

#### DEVIATIONS FROM NORMAL POSTURE

Deviations from normal posture may occur as a result of disease, heredity, poor habits of weight-bearing, or as a consequence of certain occupations. Functional deformities must be differentiated from structural deformities. A deformity is functional when it can be corrected by a change in position or weight-bearing. Structural deformities are due to bony changes or permanent contractures of soft structures; normal body alignment cannot be restored by exercise or by change of posture. However, with a structural fault, good body mechanics may compensate in some degree for the deformity.

Common posture faults are exaggeration, diminution, or reversion of the natural anteroposterior curves of the spine, or the appearance of lateral deviations. When the normal anteroposterior curves of the spine are exaggerated, lumbar lordosis and dorsal kyphosis are increased. The head is carried too far forward as a result of the exaggerated dorsal curve. Functional



may be corrected by teaching the patient the proper use of his feet in walking. With continuous practice, new walking habits can be established by improving the general body mechanics.

The signs of weak feet may be noted as the patient stands with the feet held four inches apart and parallel to each other.

1 When viewed from the front, the body weight should be disposed upon the outer part of the foot. A plumb line dropped from the middle of the patella should pass through the middle of the astragalus and through the region between the base of the first and second toes.

2 When the foot is examined from the back, bowing inward of the Achilles tendon indicates a strain on the muscles and ligaments supporting the arch (Helbing's sign).

3 Have the patient stand on a glass plate, under which a mirror is placed, facing a light and tilted at an angle of 45 degrees to the floor. Normally, the weight bearing surface is seen as a white area along the outer border of the foot. A white inner border indicates a fallen arch. The weight is borne on the entire heel and sole in the pronated foot.

4 Notice whether the patient's feet are parallel when he walks. External rotation at the hip joint causes the feet to be turned outward when walking and so produces strain in the longitudinal arch.

When the foot is examined without weight bearing the three signs noted in a fallen transverse arch are depressions behind the toes, hammer toes, and callus on the soles of the feet. Many cases of foot trouble result from placing weight on muscles weakened from disuse during an illness. Patients should be required to exercise the muscles of the feet while in bed and to wear shoes, not bedroom slippers, when they are allowed to stand or walk.

An analysis of the movements made in walking is necessary to fully understand the function of the foot. In normal walking the leg is first flexed slightly at the hip and at the knee. The foot is relaxed. The knee is then extended, the leg lowered and the foot is placed on the ground. The posterior calf muscles of the other leg then contract in order to carry the weight of the body forward. The heel is set down first in walking. In running, the toes first touch the ground. The body weight is transferred from the heel and the toes by way of the calcaneus and astragalus. As the foot gets ready for the next step, the weight is transferred forward along the outer border of the foot across the heads of the metatarsal bones to the inner border of the foot, to the big toe, and the other four toes. When the body is propelled forward, the flexor muscles of the toes, and especially of the big toes, con-

It appears on the x-ray film as an irregularity of growth in the anterior epiphyses of the dorsal vertebrae. The treatment is the same as that for structural kyphosis. Although the condition cannot be corrected, an improvement in posture helps to minimize its progression.

Lateral curvature of the spine, or scoliosis, is seen frequently. Like kyphosis, scoliosis may be functional, due to faulty postural habits; or, structural, as a result of poliomyelitis, rickets, congenital anomalies of the vertebrae, paralyzes, rib resection, and so forth. The condition is often idiopathic, developing during the age of puberty. In order to distinguish between structural and functional scoliosis, the patient is asked to relax the trunk forward, with arms hanging loosely (Adam's position). In this position, any lateral deviation of the spine disappears, if the difficulty is functional (Fig. 204); if it is structural, the deviation remains visible. Wherever there is marked lateral deviation, there is almost always rotation of the spine. When rotation is marked, even though there is but little lateral deviation, the ribs are prominent on one side and slightly concave on the other. Exercises for scoliosis are directed toward achieving the best body mechanics possible under the given circumstances. Nature usually tries to compensate for a lateral curve in one part of the spine by developing a curve in the opposite direction in another part of the spine (compensatory curve). Exercises will help to keep the shoulders level, to prevent the pelvis from tilting too much sideways, and to re-establish balance of the body weights.

#### DISORDERS OF THE FEET

It has been said that disorders of the feet are the most widely spread form of physical impairment among civilized people today. Improper shoes, functional or structural deformities, injuries, and wrong weight distribution on the feet as a consequence of faulty body mechanics are contributing factors. Modern life makes demands on the feet which they are not structurally prepared to meet. For example, continuous walking on hard surfaces or prolonged standing impose burdens which the feet are ill equipped to carry. At the same time there is a lack of the normal exercise of the foot which is necessary for its proper functioning. When shoes are chosen, the action of the foot should be kept in mind. The purpose of the foot is to support the weight of the body in standing, and to transfer the body weights in walking, running, or jumping. The normal function of the foot depends on its structure, muscle balance, and the correct distribution of weight. A structural deformity cannot be changed by exercise, whereas a functional fault

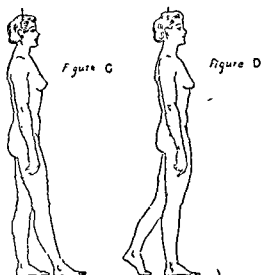

*C* Leg is lowered Foot is placed on the floor Weight is not yet transferred *D* Weight is transferred to forward foot over its outside border The heel of the hind foot is elevated as the weight is transferred

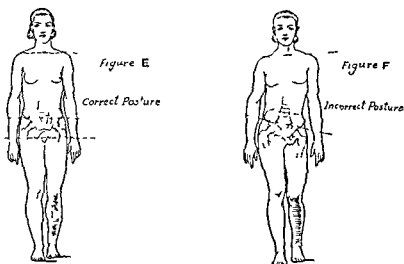

FIG 206 *E* Correct skeletal alignment in walking with pelvis held horizontal *F* Incorrect walking posture with exaggerated lateral tilting of pelvis.

tract and cause the toes to grip the floor. Therefore, during exercise training, special attention must be paid to these muscles. The extensors of the toes frequently become contracted because of faulty standing and walking habits, or improper shoes. The flexors lose their natural tonus, and as a result, the metatarsal arch becomes flattened. To strengthen the flexors the toes should be bent under, at first while the subject is in the sitting position to eliminate weight-bearing; later on, when in a standing position (Fig. 205).

A patient may be taught to walk correctly by requiring him to execute the four movements of the natural walk in an exaggerated manner. These movements consist in bending the hip and knee joints; extending one knee; lowering the leg and placing the foot on the ground; then, transferring the weight to the foot forward (Fig. 206).

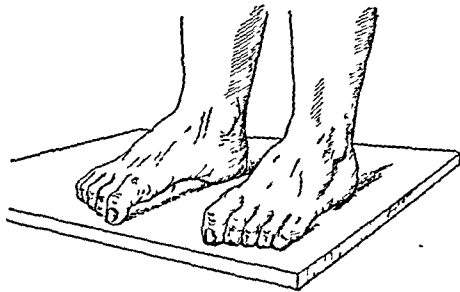

FIG. 205. Flexion of toes. Patient stands with feet straight and slightly apart and flexes toes as much as possible.

#### POSTURAL LOW BACK PAIN

Faulty body mechanics which have existed for a prolonged period of time predispose to strain of the sacro-iliac and sacrolumbar region because of the continuous wrong weight-bearing. When the normal relationship between spine and pelvis is changed, the inclination of the pelvis is either decreased

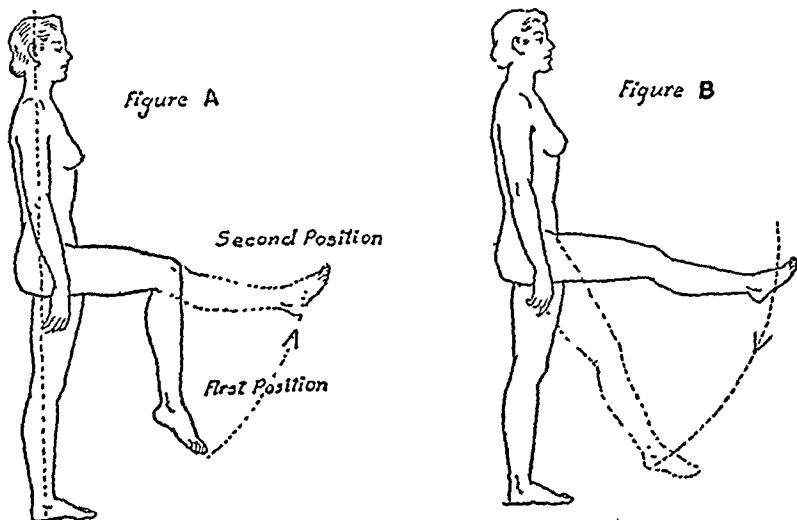

FIG. 206. Analysis of walking movements. *A.* First position. Flexion of hip and knee. Foot hangs relaxed. Dotted line shows extension of leg. *B.* Lowering of leg.

alignment should be started when the abdominal muscles are strong enough to hold the pelvis fixed during the raising and lowering of the legs

*Exercise 5* The patient lies supine His arms are bent with the hands on the

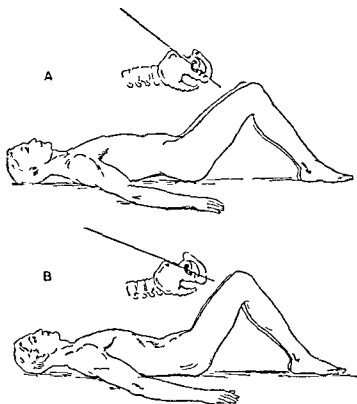

FIG 207 Exercise for rotation of pelvis *A* Patient lies supine with legs flexed and feet resting on floor Arms at side and relaxed *B* Flattening out of lumbar spine without raising chest or shoulders Degree of change of pelvic inclination is shown

shoulders An assistant holds the ankles The patient sits up, keeping the back aligned, and lies down in the same manner (Fig 191)

*Exercise 6* The patient lies prone and relaxed He contracts the glutei and holds them in this position for two or three seconds Then, he relaxes for a period two to three times as long as that in which the muscles were held contracted This exercise should be repeated several times (Fig 210)

*Exercise 7* The patient lies prone with the arms extended over the head The operator holds the legs while the patient reaches forward as far as possible and then raises the arms and trunk, holding these structures aligned (Fig 211)

The posture exercises just described can be used to rebalance the weights of the body In addition, the following exercises will be helpful in teaching the patient how to superimpose the suprapelvic structures They should be preceded by less difficult exercises

or, more frequently, increased. With a greater lumbosacral angle the origin and insertion of the sacrospinalis muscles become approximated and consequently shorten. When a larger proportion of the weight of the abdominal organs is carried by the abdominal wall instead of by the ilia and pelvic floor, the muscles of the abdominal wall become overstretched. Eversion of the feet or internal rotation of the thighs are factors contributing to low back strain. A decrease in the flexibility of the spine can result from lack of use, disease or advancing years. The etiology must be borne in mind when attempting to correct postural low back pain through exercise. At first, exercises should be directed toward equalization of muscle pulls. The tense sacrospinalis group should be relaxed and the relaxed abdominal muscles should be strengthened. The oblique abdominal muscles usually require particular attention. When indicated, an effort should be made to increase the flexibility of the spine. Once some of the pain has disappeared, one should start to rebalance the body weights from the feet up. The following exercises are useful in correcting postures for low back pain.

*Exercise 1.* The patient lies on his back with knees flexed and feet resting on floor. The arms are held beside the body with the palms toward the floor. The patient is instructed to flatten out his lumbar spine without elevating the thorax. If he is unable to do this, the assistant flexes the patient's knees and hips passively to make him experience the sensation of his spine flattening out. At first, this exercise is performed with the thighs flexed. The sequence of the movements are illustrated in Figure 207. This exercise is used for the relaxation and mobilization of the lumbar spine rather than for the correction of the position of the pelvis.

*Exercise 2.* Abdominal breathing. The patient assumes the same position as in Exercise 1. He is directed first to exhale and then to inhale. During the inhalation he could raise the anterior abdominal wall slightly without elevating the chest; he then relaxes the abdomen and exhales. This procedure is repeated three times. Then, natural breathing is performed three times.

*Exercise 3.* The patient lies supine with the legs drawn up to the chest. The arms are held at shoulder level. Both legs are dropped over to the right without raising the arms off the floor, then brought back to the midposition, and then dropped to the left in the same manner (Fig. 208). This exercise increases mobility of the lumbar spine and strengthens the oblique abdominal muscles.

*Exercise 4.* The same position is assumed as in Exercise 3. The knees are stretched upward. The lower part of the legs is relaxed. This exercise is done to gradually stretch the hamstrings (Fig. 209).

These four exercises are done until the pain is diminished. Other simple abdominal exercises may be added. Exercises directed toward correct body

The patient shown in Figure 218 illustrates poor posture. He suffered from arthritis, emphysema, and asthma, in addition to obesity and poor posture. He complained of various aches and pains in nearly all parts of his

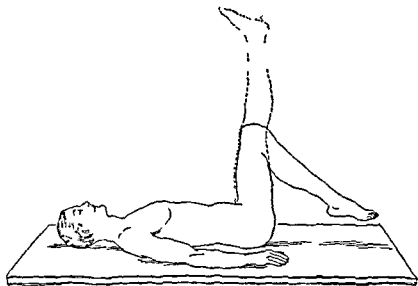

FIG. 209 Hamstring stretching. Patient in supine position. Thigh flexed at right angle. Lower part of the leg hangs loosely. One or both legs are extended upward until they are vertical and then are returned to the starting position. For additional hamstring stretching the foot can be dorsiflexed when the leg is fully extended.

body. Physical examination showed that he stood with feet pronated. The longitudinal and transverse arches were flattened, the toes were held in dorsiflexion. There was external rotation at the hip joint. The forward inclination of the pelvis was increased. Lack of tonus of the abdominal muscles was evidenced by a protruding abdomen and umbilical hernia. The lumbar curve was increased with a compensatory dorsal kyphosis. The head was held forward with chin down. A plumb line from the tip of the mastoid process passed anterior to the acromion process, in front of the knees and toward the toes, well forward of its normal position in front of the astragalus.

All joint motions were limited, particularly those of the spine. On forward bending the tips of the fingers were several inches from the floor, even though the knees were held flexed because of the tightness of the hamstrings, and the apex of the curve of the back occurred in the dorsal instead of the lumbar area. Motion in the lumbar region was almost absent (Fig. 219). It was impossible for him to extend his arms adequately, particularly in the completely adducted position, they were held flexed at the elbow. He could not place his arms back of his ears. The respiratory movements

*Exercise 8.* This exercise is recommended by Mensendieck. The patient stands with feet parallel, arms raised over the head with the palms facing forward, and stretches upward from the abdomen. Care should be taken to prevent backward

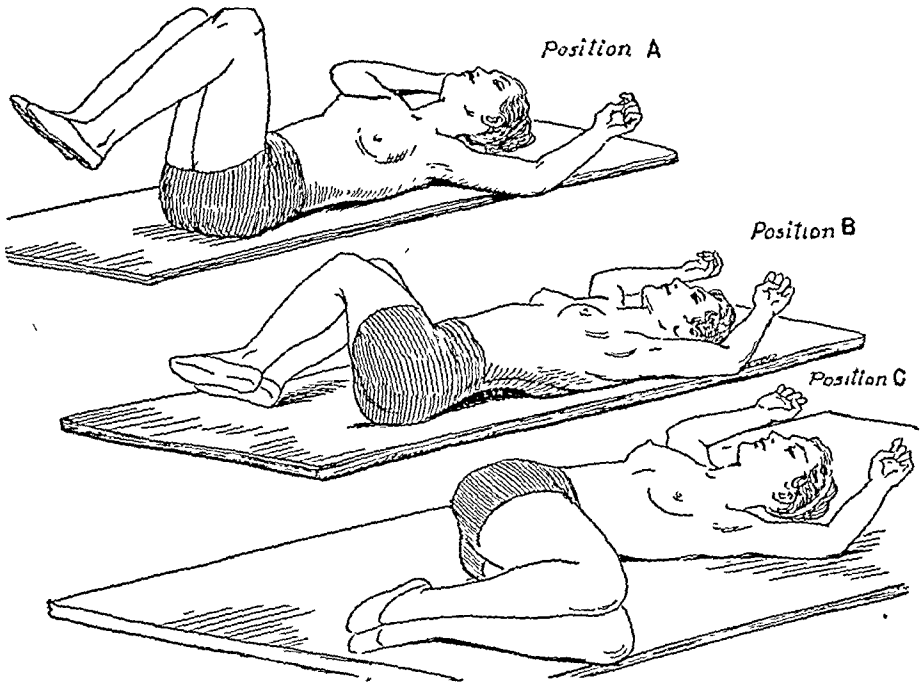

FIG. 208. Exercise for abdominal muscles and spinal rotation. *A* Patient lying on back with legs flexed. Arms at right angles at shoulder level. *B*. Legs are dropped laterally to the floor. Shoulders are held firm on the floor. *C*. Legs are moved back and then dropped in the same manner in the other direction.

deviation of the pelvis; if there is difficulty in maintaining the position of the pelvis, the patient should contract the gluteals slightly. Starting at the lowest flexible section of the spine, the patient bends forward slowly, keeping the head between the arms, until maximum flexion is reached. (He need not attempt to touch the floor.) The highest arc of flexion is then at the lumbar and not at the dorsal area. The patient then gradually straightens up, while keeping the arms extended above his head. The extension is also begun from the lowest possible part of the spine. The arms are lowered in either the forward or the side position. The latter movement is accomplished by contraction of the rhomboids, and of the middle trapezius if there is a weakness of the shoulder blade adductors. Care should be taken that the ankle, knee, and hip joint remain aligned one above the other throughout the exercise (Fig. 212). If the patient has a greatly increased dorsal rotundity this exercise should not be performed. There are a number of stretching exercises which are helpful in difficulties causing postural low back pain. These are illustrated in Figures 213 to 217.



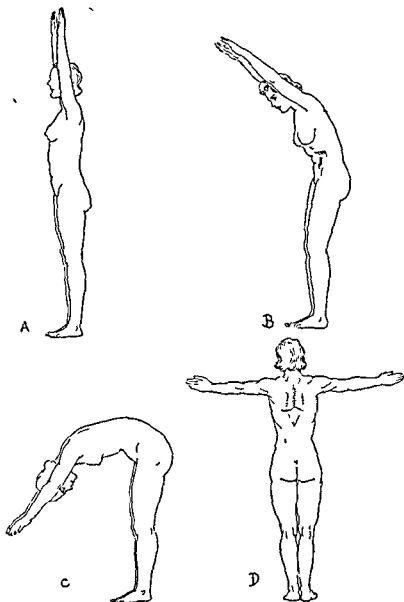

FIG. 12 Forward bending of trunk as described by Mensendieck. *A* Subject raises arms behind ears. She stretches upward experiencing the sensation of a pull which starts in the region of the abdominal wall. *B* Flexion is produced at lowest part of spine by the contraction of gluteal and abdominal muscles. *C* Completion of flexion. Highest part of arc should be over lumbar area. Legs should be vertical and inclined backward. *D* The trunk is raised. The upper extremities held in a horizontal position are pulled toward each other by the contraction of the trapezius and the rhomboid muscles.

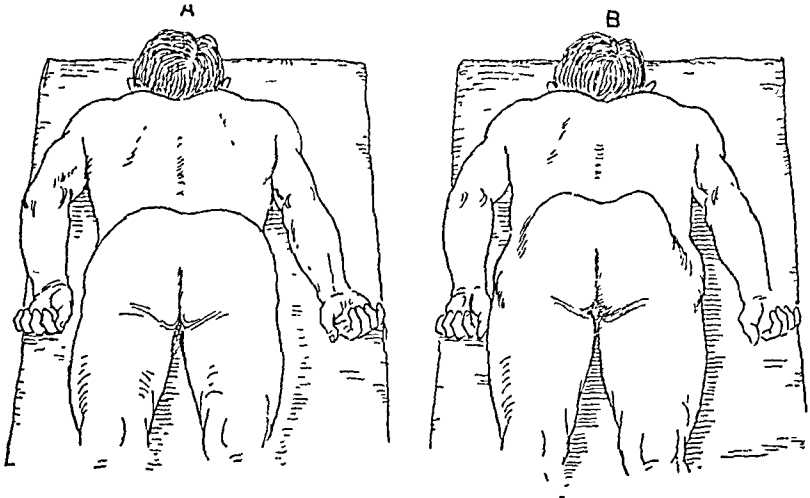

FIG. 210. Contraction of gluteus maximus. *A.* Relaxed position. *B.* Contracted position.

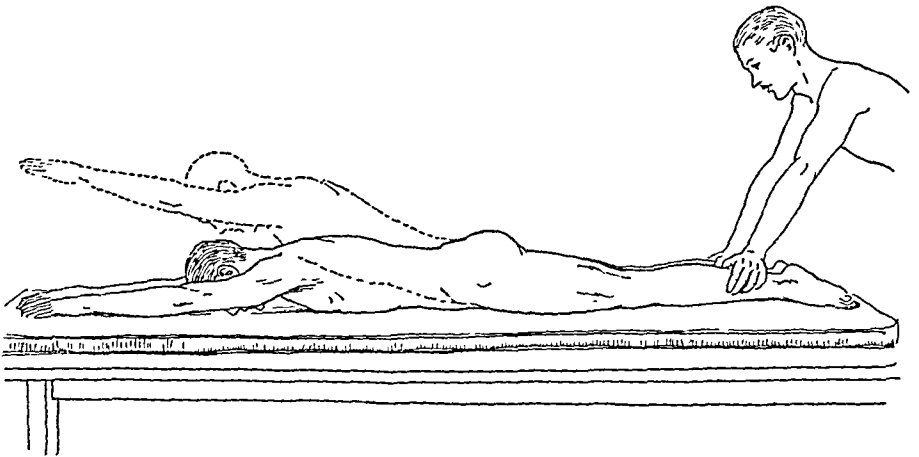

FIG. 211. Raising trunk from prone position. Operator holds ankles down. Arms are extended over head and stretched as far as possible. Trunk is raised, keeping back aligned. Head remains between arms.

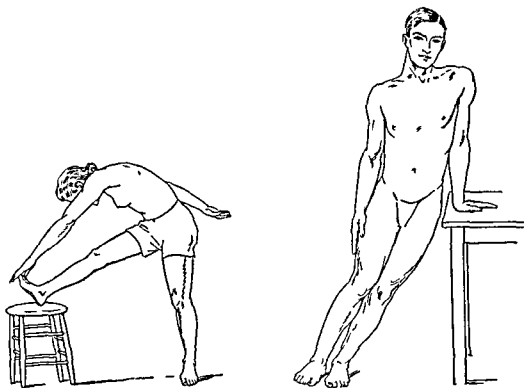

FIG. 215 Exercise for stretching soft structures of leg and back. Heel placed on stool with foot in dorsiflexion and leg held straight. Patient touches toes with opposite arm. In doing so, she approximates thorax to thigh as much as possible.

FIG. 216 Stretching of tensor fascia lata. (For description see text, page 440.)

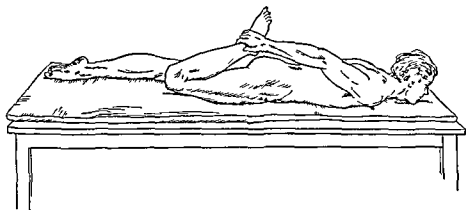

FIG. 217 Active stretching of anterior fascia.

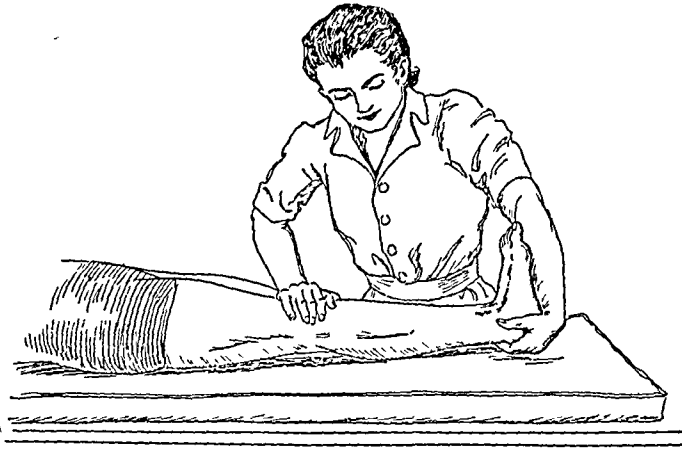

FIG. 213. Passive stretching of Achilles' tendon. Operator's right hand helps to prevent flexion of knee. Heel rests in palm of operator's left hand. Inclination of operator's forearm along with rest of her body produces dorsiflexion of foot.

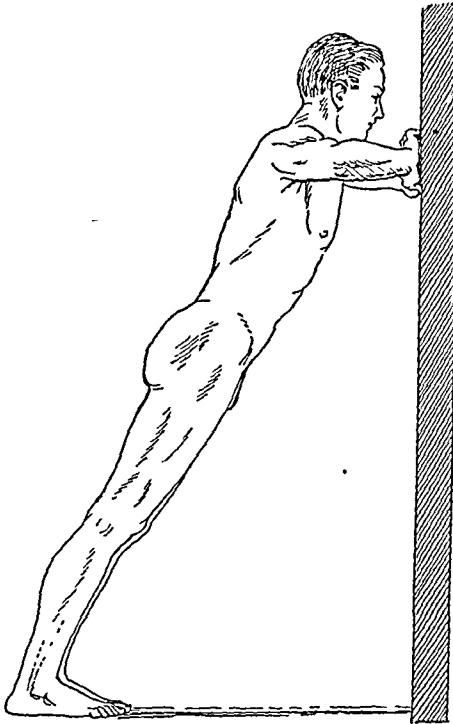

FIG. 214 Active stretching of Achilles' tendon. Legs and body are held aligned while patient inclines body toward wall. Feet remain on ground

of the rib-cage were restricted. The chest was held in the position of inspiration (Fig 220)

During the first days of treatment he was confined to bed (except for

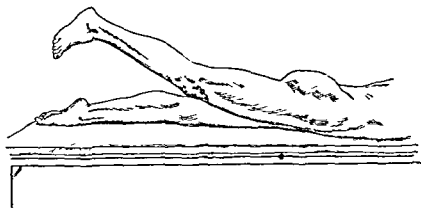

FIG 221 Exercise for extension of leg. Leg is held straight. Glutes are contracted

bathroom privileges) He was placed on a diet low in calories and high in vitamins. Subsequently, he was fitted with a corset to support his abdomen. Metatarsal bars were added to his shoes and the inner side of his heels were raised. To cause relaxation of tense muscles, to increase tonus of weak muscles, and to increase joint motion, exercises were given, gradually increasing in duration and in degree of motion. At first, exercise periods of ten minutes each were carried out three times a day, active and passive motions were performed with particular emphasis on the region of the lumbar spine. After several days, the patient was required to exercise for five minutes every hour during the day. The instruction period lasted for one half hour and was given once a day. An effort was made to improve the tonus of his abdominal muscles. He was given breathing exercises, with special emphasis on exhalation. The exercises previously described for the correction of postural defects were administered. The character, duration, and sequence of these exercises were varied in accordance with his requirements (Fig 221)

### SPECIAL EXERCISES

#### EXERCISE AND DIABETES

The effect of exercise on the diabetic patient has been summarized in an editorial in the *Journal of the American Medical Association*. The conclusions are as follows:

1. Along with diet and insulin, exercise is an accepted part of the present-day treatment of diabetes.

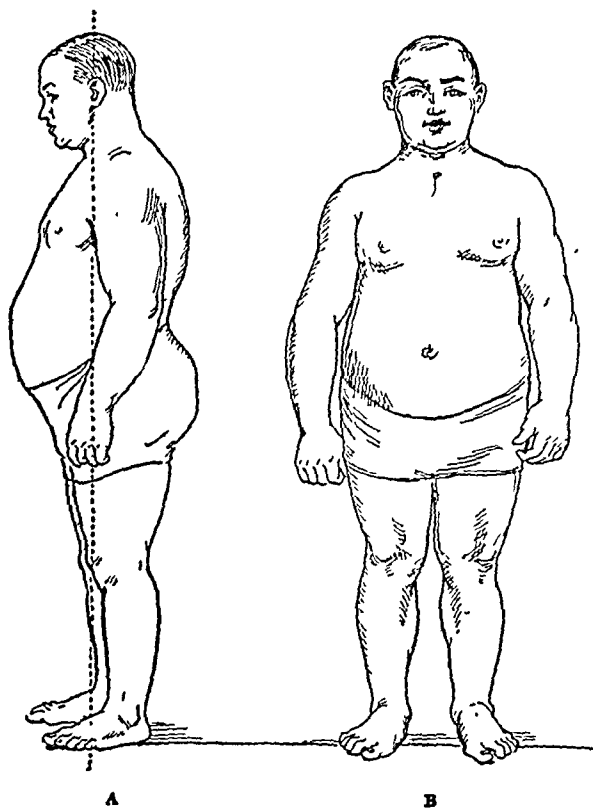

FIG. 218. Subject with poor posture. *A*. Lateral aspect. The line of gravity is displaced anteriorly; increased pelvic angle; pendulous abdomen, flexion of elbows; exaggeration of natural curves of spine. *B*. Anterior view showing feet everted; flattened longitudinal and transverse arches. Halux valgus, internal malleolus lowered; patella rotated externally. Thighs rotated; left shoulder higher than right; head poorly balanced. Arms held forward instead of hanging relaxed in their correct anatomic position.

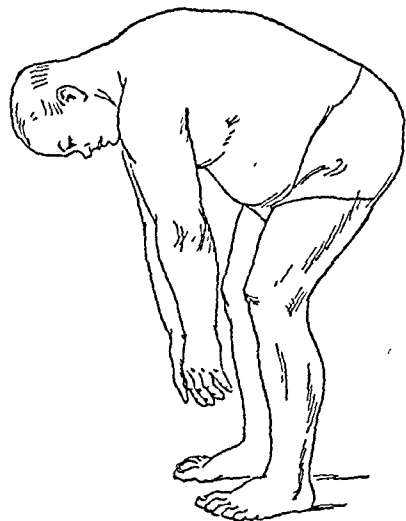

FIG. 219. Same subject as in Figure 218, bending forward as far as he can. The marked shortening of hamstrings necessitates the knee flexion. There is a lack of flexion in the lumbar and cervical areas of the spine. The abdominal wall is relaxed. Inability to permit arms to hang relaxed.

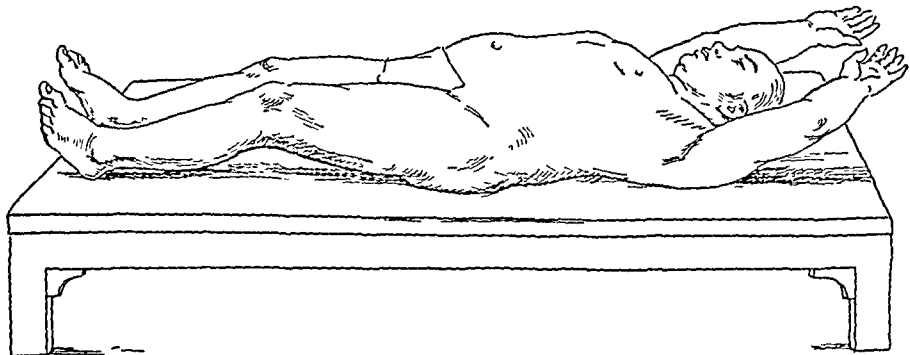

FIG. 220. Same subject as in Figures 218 and 219. Lying position shows inability to straighten knees because of marked shortening of hamstrings; restriction of extension of shoulder joint; high elevation of rib cage indicating holding of position of thorax in inhalation. Arch of back is not evident because of obesity.

The exercises recommended by McKenzie for patients with inguinal hernia are as follows

*Exercise 1* Patient lying on back Place one hand across abdomen, the other protecting the ring Inhale deeply Exhale by pressing on abdominal wall until voluntary contraction is performed without placing the hand over the abdomen

*Exercise 2* Patient lying on back, one hand across abdomen, the other protecting the ring Inhale and exhale without drawing in the abdomen In this way, control of the abdominal wall is obtained while the hernia is protected by placing the finger over the external ring In one or two treatments it is possible to teach the patient how to find the external ring and how to protect it in the various exercises

*Exercise 3* Patient lying on back, one hand behind the neck, the other covering the external ring Raise the head and shoulders, twisting them to the side away from the hernia In this way, the oblique muscles of the affected side are put into strong contraction If the movement be symmetric, the rectus alone will receive the strain

#### OTHER SPECIAL EXERCISES

Other special exercises are described in various sections devoted to a consideration of physical measures in the treatment of a number of conditions These include tabes dorsalis (page 509), spastic paralysis (page 488), asthma (page 601), pulmonary tuberculosis (page 597), heart disease (page 518), arthritis (page 398), constipation (page 542), and the postpartum state (page 573)

#### CONSIDERATIONS CONCERNING BED REST

It has come to be recognized that bed rest, so generally required of patients suffering from medical and surgical conditions, is not an unmixed blessing Dock and others have pointed out that complete bed rest can cause hypostatic pneumonia, pulmonary congestion, acute pulmonary collapse, pulmonary embolism from compression of veins in the calf slowing venous circulation with resulting thrombosis, edema of the lungs, left side heart failure, loss of appetite, constipation, distention, urinary retention, loss of nitrogen, potassium, phosphorus, and calcium, calcinuria, renal stones, atrophy of bone, loss of vasomotor tone and blood volume resulting in hypotension and tachycardia, bed sores, and muscle and skin wasting To avoid these dangers it has been suggested that patients with latent heart failure or coronary arteriosclerosis following surgery, or patients after cerebral or cervical trauma or operations, who are not fatigued by sitting up, whose fever does not exceed 100° F and who are not in shock, should be permitted to sit up for several

2. For exercise to exert its maximum benefit, sufficient insulin should be available in the body at the time of exercise.

3. From the practical point of view the logical sequence for the diabetic patient, after arising in the morning, would seem to be insulin, exercise and breakfast rather than exercise, insulin and breakfast. It seems needless to point out further advantage of the two, three or more additional periods of exercise during the day.

4. The exercise should be mild enough so that undue fatigue is not produced.

Because of the danger of gangrene in older patients, the following regime is suggested by Brandaleone, Standard, and Ralli.

1. Care of the feet: (a) The feet should be soaked in a basin of water, warm and soapy, for five minutes every day. (b) They should be dried thoroughly with a Turkish towel, being careful to dry between the toes. (c) They should be massaged with a little alcohol. (d) They should be massaged with lanolin, especially the soles of the feet where there are calluses, and the heels. In this way, the caluses are softened and will eventually rub off.

2. Foot exercises: (a) Sitting on the edge of the bed, point the toes upward and then downward. Repeat this ten times. (b) Then make a complete circle with the foot ten times. (c) Then raise both legs to an angle of 45 degrees. As a support for the legs, place a chair upside down on the bed. Leave them in this position for three minutes. (d) Then, let them hang down over the side of the bed again for three minutes. (e) Place them flat on the bed for three minutes. Cover with a blanket. These exercises should be repeated six times. They should be done daily and if the feet have a tendency to coldness, they should be done twice a day.

#### EXERCISE AND INGUINAL HERNIA

Exercise will not cure inguinal hernia. However, bodily movements which increase the strength of the abdominal muscles serve to correct poor posture. These are indicated in prevention of hernia and in the care following herniotomy.

In the presence of congenital weakness, coughing, vomiting, lifting, and the like, may increase the intra-abdominal pressure sufficiently to produce a hernia. Weak abdominal muscles and poor posture, therefore, may act as predisposing causes to the production of inguinal hernia when the intra-abdominal pressure is increased.

The purpose of exercises is to strengthen the abdominal muscle and "to cultivate alertness, control and self-consciousness in these muscles, thus causing them to respond instantly and automatically to any sudden strain that may be thrown upon them."



- and underwater exercises In *Handbook of Physical Therapy* Chicago, American Medical Association, 1939
- GOLDTHWAIT, J E, BROWN, LLOYD T, SWAIM, L T, and KUHNS, J G *Body Mechanics in Health and Disease* Ed 3 Philadelphia, Lippincott, 1942
- HARRISON, T R Abuse of rest as therapeutic measure for patients with cardiovascular disease *JAMA*, 125 1075, 1944
- JACOBSON, E The technic of progressive relaxation—General form In *Principles and Practice of Physical Therapy* Hagerstown, Maryland, Prior, 1935, Vol III, chap 18
- KAISER, H Buerger exercises in treatment of diabetic patients with peripheral vascular disease *Physiotherapy Rev*, 20 18–20, 1940
- KARPOVITCH, P V Textbook fallacies regarding the development of the child's heart *Research Quart*, 6 3, 1935
- KARPOVITCH, P V, STAIR, M P, KIMBRO, R U, STOLL, C G, and WEISS, R A Physical reconditioning after rheumatic fever *JAMA*, 130 1198, 1946
- LEWIS, T *The Soldier's Heart and the Effort Syndrome* New York, Hoeber, 1918
- LING, P H *The Gymnastic Free Exercises* London, Grombridge & Sons, 1853
- LOVETT, R W *The Treatment of Infantile Paralysis* Ed 2 Philadelphia, Blakiston, 1917
- MCCURDY, J H, and LARSON, L A *The Physiology of Exercise* Ed 3 Philadelphia, Lea & Febiger, 1939
- McKENZIE, R T *Exercise in Education and Medicine* Philadelphia, Saunders, 1923
- MENNEL, J B *Physical Treatment by Movement, Manipulation and Massage* Ed 4 London, Churchill, 1940
- MENSENDIECK, B M *The Mensendieck System of Functional Exercises* Portland, Maine, Southworth Anthonsen Press, 1937
- MORGAN, W H, and HITE, O L Physical therapy in gastro-intestinal conditions In *Principles and Practice of Physical Therapy* Hagerstown, Maryland, Prior, 1932 Vol I, chap 21
- MORTON, D J Physiological considerations in treatment of foot deformities *J Bone & Joint Surg* 19 1052, 1937
- PHILPS, W M In *Practitioners Library of Medicine and Surgery* New York, Appleton, 1936, Vol IX, Chap 20
- RATHBONE, J L *Residual Neuromuscular Hypertension Implications for Education* New York, Columbia University, 1936
- ROBINSON, H C The physical education of cardiacs *J Health & Phys Educ* 9 289, 1935
- SCHNEIDER, E C *Physiology of Muscular Activity* Philadelphia, Saunders, 1933
- SCHOTT, T On the treatment of chronic diseases of the heart *Boston M & S J* 156 632, 1907

periods during the day and to sleep in the orthopneic position. In many conditions, chair rest is better than bed rest. The commode should be used more often than the bed pan.

Harrison advises that patients with congestive heart failure should be allowed out of bed for several hours a day as soon as severe dyspnea at rest has subsided. Following myocardial infarction, the recumbent position should not be prescribed for more than two or three weeks after the more acute and alarming symptoms have subsided. Where the sitting position is more comfortable, reclining should not be insisted on. In angina pectoris, rest in bed should not exceed one or two days, except in patients especially liable to immediate development of myocardial infarction, as indicated by increasingly frequent and prolonged attacks at rest. In all patients with severe forms of heart disease, activity should be kept below the symptomatic threshold at which dyspnea or pain is induced.

Karpovich found that patients convalescing from rheumatic fever could safely participate in a graded system of physical exercises within two weeks after clinical cessation of the pathologic rheumatic activity. The conventional delay in the beginning of physical reconditioning was reduced from 77.3 days to 16.2 days without causing an increase in the incidence of cardiac damage during six to twelve months of observation.

#### REFERENCES

- ALLEN, E. V. Recent advances in the medical treatment of peripheral vascular diseases. *J.A.M.A.*, 113 : 2375-2381, 1939.
- BEST, C. H., and TAYLOR, N. B. *The Physiological Basis of Medical Practice; a University of Toronto Text in Applied Physiology*. Ed. 2. Baltimore, Williams & Wilkins, 1939.
- BLOCH, A. *Harmonious Development of Women's Bodies*. New York, Ray Long & Richard R. Smith, Inc., 1932.
- BRANDALEONE, H., STANDARD, S., and RALLI, E. P. Foot treatment in patients with diabetes mellitus. *Ann. Surg.*, 105 : 120, 1937.
- BRESLIN, J. Exercise in convalescence from pulmonary tuberculosis. *U. S. Vet. Bureau, Med. Bull.*, 7 : 72, 1931.
- BRUNNSTROM, S. The changing conception of posture. Methods of dealing with faulty posture. *Physiotherapy Rev.*, 20 : 1-6, 1940.
- CARLSON, E. R. *Born That Way*. New York, Day, 1941.
- DOCK, W. Undesirable effects of bed rest. *S. Clin. North America*, 25 : 437, 1945
- FRAENKEL, H. S. *The Treatment of Tabetic Ataxia* Translated by L. Freyberger Philadelphia, Blakiston, 1902.
- GAENSLER, F. J. Aids in muscle training with special reference to sling suspension

## CHAPTER XIII

# OCCUPATIONAL THERAPY

**W**ATERS HAS SAID THAT "THE GOAL OF MEDICINE today is to prevent disease if possible, to cure it if there is sufficient knowledge, and if a complete cure is not possible, to enable the patient to find a way of life which is satisfying to him" At times, physical restoration may not alone serve to bring the patient back to a normal life, it may become necessary for the physician to guide his patient into a new way of life Occupational therapy has been defined by Dr H A Pattison as "any activity, mental or physical, definitely prescribed and guided for the distinct purpose of contributing to and hastening recovery from disease or injury" It employs handicrafts, recreational and educational activities, prescribed by physicians and administered by trained therapists

The use of occupations as agencies for treatment of the sick and disabled is by no means a new idea The Greek philosopher Galen, stated about 172 A D that "employment is nature's best physician and is essential to human happiness" Actual records of the value of occupations as curative measures go back as far as the latter part of the eighteenth century, when Dr Phillippe Pinel, in France, and Dr William Tuke, in England, liberated the insane from chains and placed them at work in regular, normal occupations The pioneer work in this field in America was done by Dr Benjamin Rush and Dr Kirkbride of the Pennsylvania Hospital In the early nineteenth century, McLean Hospital at Waverley, Massachusetts, was the first institution to employ a full time occupational worker In 1908, the Chicago School of Civics and Philanthropy, under the direction of Henry Favill, gave the first regularly organized course to train workers in this field Interest grew gradually, until, with the coming of the first World War, the possibilities which existed for rehabilitating the war injured through the use of occupations opened up new fields The demand for trained workers was so great that numerous short courses were established to train qualified workers in the use of occupations as definite forms of treatment After the war, the courses of training were lengthened and their content increased, until, at

- STANDER, H. J. In J. W. Williams, *Obstetrics*. New York, Appleton-Century, 1936.
- STEINDLER, A. *Mechanics of Normal and Pathological Locomotion in Man*. Springfield, Ill., Thomas, 1935.
- TICE, F. *Practice of Medicine*. Hagerstown, Maryland, Prior, 1940, Vol. VI, chap. 3, 4.
- WILKES, E. T., and JUST, E. Corrective supervised exercises for postural defects. *N. Y. State J. Med.*, 37 : 18, 1937.
- WILLIAMSON, B. *Vital Cardiology*. Baltimore, William Wood, 1934.
- WRIGHT, W. G. *Muscle Function*. New York, Hoeber, 1928.

As more trained workers become available, and the possibilities of occupational therapy are more widely appreciated, the fields in which it is used are becoming more numerous. At first, occupational therapy was employed in hospitals devoted to the care of mental diseases. Later, it came into use for physical restoration and diversional work in general hospitals. Though these are still the largest fields of application, much work of this kind is also being done in tuberculosis sanatoria, orthopedic hospitals, children's hospitals, convalescent homes, agencies for the home bound, schools for the training of mental defectives, institutions for the blind, the chronically ill, the crippled, and so forth.

The ultimate aim of all forms of occupational therapy is to aid in the physical, mental, social, or economic adjustment of the individual. At times, this requires reorientation of the patient's activities in order to place him in an occupation suitable for his limited capacity.

Most occupational therapy activities can be classified as diversional, restorative, or re-educational. Diversional treatment is given to occupy the mind and to make the patient as contented as possible by stimulating new interest. Curative occupations, carefully selected and prescribed to meet individual needs, can often develop powers of concentration, judgment, and initiative, as well as will power and optimism, which have become weakened by a period of enforced idleness. Through the use of recreational activities, as well as crafts, a lethargic or neurotic patient may acquire a stimulating interest, which not only encourages his recovery but often leads to the establishment of a hobby which is pursued in later life. Even in the fairly acute stages of an illness, simple games, light reading, listening to music, and the like, will help to prevent the depression which frequently envelops a formerly active person when confined to bed. Later, collections of postal cards (for children), shells, stamps, and other materials not too large to handle in bed, can be suggested by the physician. He will find that this display of interest in his patient's comfort will be encouraging and stimulating. As the patient's strength increases, other occupations of a diversional nature can be permitted. Finger painting is an excellent medium for patients who are confined to bed. The paint is water soluble, and thus easily removed from both patient and bedclothing. Finger paint is a colorful, stimulating material to work with, and is especially valuable for persons who are "sure" they cannot paint or draw as results are quickly achieved. The physical activity involved is not too great, and the paintings can be used to brighten the walls of the patient's room. During later convalescence they can be utilized, if desired, in numerous forms of simple or more complex handi-

the present time, there are certain definite standards which must be met by schools qualified to train workers acceptable for membership in the national registry.

There now are six schools offering courses which have been approved by the American Medical Association and the American Occupational Therapy Association. In addition, there are four new schools which conform to the required standards, but which cannot be officially approved until they have graduated their first class. Each of the accredited schools offers a three-year course, and several offer a five-year course leading to a B.S. degree as well as to a certificate in occupational therapy. Applicants for the shorter courses must have had at least one year of college or professional training. A typical course of study offered by one of the schools of occupational therapy contains the following subjects:

Biological sciences: Anatomy and kinesiology; neurology; pathology; physiology; psychiatry (elementary); psychiatry (advanced with clinical studies); psychology.

Social sciences: Adult and vocational education; hygiene; social service and rehabilitation; sociology.

Clinical subjects: Blindness; heart disease; tuberculosis; first aid.

General medicine and surgery: Pediatrics; mental deficiency; orthopedics; special therapeutics.

Theory of occupational therapy: History and principles of occupational therapy; principles and application of occupational therapy; occupational therapy case study and organization.

Therapeutic occupations: Bookbinding; carving; children's activities; design; applied design; dressmaking; marionettes; mechanical drawing; metal work; minor crafts (knotting, braiding, etc.); needlecraft; pottery; reedwork; weaving; woodwork.

Recreation: Games and folk dancing; gardening; music; public speaking and dramatics; recreational organization and leadership.

Several of the schools offer postgraduate courses in particular fields, such as physical restoration after injuries, and work with cerebral palsy cases. Brief seminars or other short courses are valuable in enabling the individual therapist to benefit by the research and experiences of other workers specializing in particular aspects of this field. Some of these are given by schools of occupational therapy. Others are offered by special institutes sponsored by state or regional associations of occupational therapy (of which twenty are now in existence), or by the American Occupational Therapy Association, with headquarters at 175 Fifth Avenue, New York.



FIG 222 Clay modeling May be used for finger flexion as well as for diversion The fingers are the most valuable tools for this work

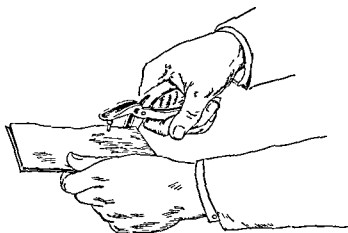

FIG 223 Punching a leather wallet provides an interesting method of obtaining finger flexioning

crafts such as bookbinding, covers for portfolios and cardboard wastebaskets, and for decorative screens of various sizes.

Clay modeling (Fig. 222) is another good craft which may be started as a bed occupation. First the patient can make small figures or bas-reliefs which are not too heavy for weak fingers. If the interest in this craft persists until the convalescent period, more ambitious projects may be attempted. Soap carving, chip carving, leather punching (Fig. 223) and lacing (Fig. 224), tooling of thin metals (Fig. 225), basketry, weaving on cardboard or small table-looms, belt knotting, making of stuffed toys and simple forms of sewing, sketching, water color or oil paintings, are all forms of light crafts easily managed in bed, and valuable in diverting the patient's attention. This list, of course, can be expanded.

It is important that the patient work in a comfortable position. To prevent undue fatigue, equipment must be so arranged as to be readily managed by the patient. If he must remain in one position for long periods of time, it may be necessary to adapt the equipment to his special needs. If a bed table is used, it should not be too high or too low. A back support should be used when necessary. The light should be arranged in a manner which will avoid shadows and any direct glare. Accessory equipment should be within easy reach so that the patient is not completely dependent on an attendant. A box to hold all material and equipment is helpful. When energy and interest are at a low ebb a variety of operations should be planned. Several short sessions at different times of day will usually prove of greater benefit than an equal amount of time expended in one period.

It has been said that occupational therapy differs from other forms of treatment in that it is given in increasing doses as the patient's condition improves. The work periods, however, should be increased gradually. It is important to guard against too much zealotry on the part of a patient who desires to do more than is good for him. There are several groups of patients, particularly cardiac patients and children with rheumatic heart disease, for whom some occupation is highly essential. However, it must be carefully graded and supervised. Children suffering from rheumatic heart diseases may be irritable and restless though required to remain quiet. Light, sedative, diversional occupations which do not tax their strength may quiet them and render them more receptive to the necessary hospital routine. In chorea, the child should be given only tools or materials with which it will be impossible for him to injure himself. Many convalescing cardiac patients are obsessed by the fear that *any* activity will bring about a return of their symptoms. It is only through carefully prescribed occupations of



gradually increasing difficulty and for gradually lengthened work periods that these patients can be made to realize that they can adapt themselves to their condition and live an active life

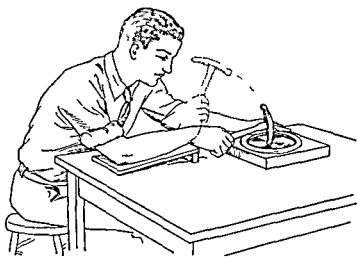

FIG 226 Hammering a metal disk into an ash tray Holding the arm still on the wooden stand provides palmar flexion and dorsiflexion of the wrist. Without the stand some elbow flexion can be obtained

Patients suffering from skin disorders form a group for whom diversional occupational therapy is valuable. Unoccupied hands have a tendency to scratch. Unoccupied minds worry. The patient who sleeps most of the day because he has nothing better to do, stays awake most of the night bothering other patients and the nursing staff and thinking of things to ask the doctor the next day. It has been said that occupational therapy is based on the mental mechanism that permits but one idea to occupy the focus of attention at a given time, and this factor is particularly valuable in the treatment of patients with skin diseases. Hammering a piece of copper (Fig 226) into a beautiful and useful bowl or ash tray (at the same time unconsciously hammering away some of the feelings of resentment against the world) can divert the attention of the dermatological patient.

Occupations which are mainly diversional may be chosen in accordance with the patient's interest and desires, keeping his background, occupation, and experience in crafts, or lack of it, in mind. The chief purpose is to arouse the patient's interest in something constructive within his physical limitations, but sufficiently complicated to require concentration on the work being done rather than on the illness.

Patients with chronic ulcerative colitis have benefited from occupational therapy. This disease may be influenced by psychological factors. At the

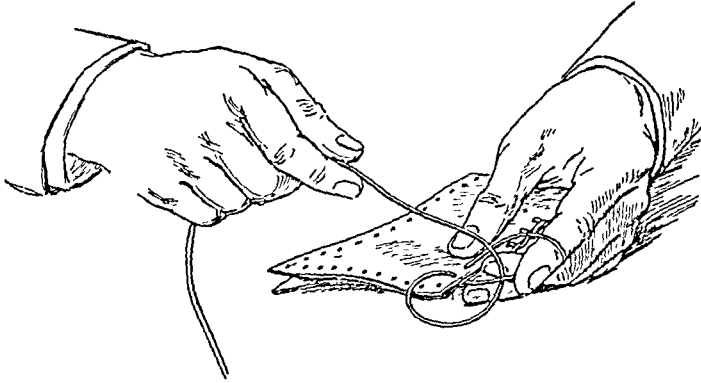

FIG. 224. Lacing a leather wallet. Finger flexion and palmar and dorsiflexion of wrist can be obtained in working with a short lacing; elbow flexion and extension, shoulder abduction and adduction when a long lacing is used.

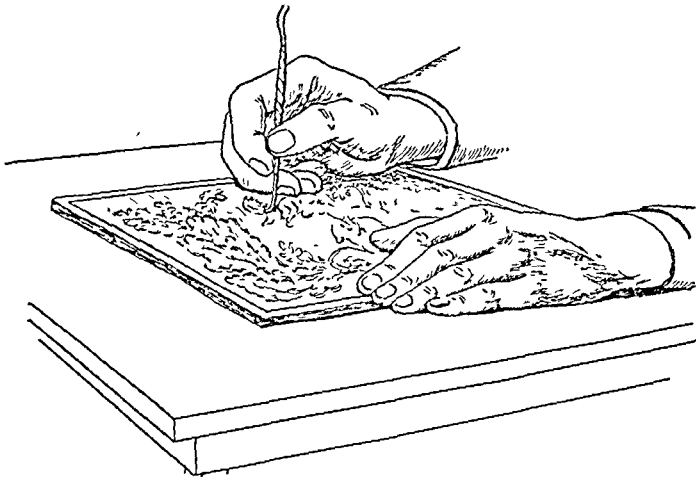

FIG. 225. Tooling of thin metals provides finger flexion and extension. The same technique is used in leather tooling.

gradually increasing difficulty and for gradually lengthened work periods that these patients can be made to realize that they can adapt themselves to their condition and live an active life

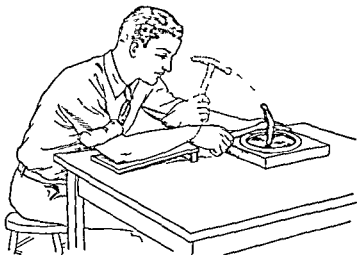

FIG 226 Hammering a metal disk into an ash tray Holding the arm still on the wooden stand provides palmar flexion and dorsiflexion of the wrist. Without the stand some elbow flexion can be obtained

Patients suffering from skin disorders form a group for whom diversional occupational therapy is valuable. Unoccupied hands have a tendency to scratch. Unoccupied minds worry. The patient who sleeps most of the day because he has nothing better to do, stays awake most of the night bothering other patients and the nursing staff and thinking of things to ask the doctor the next day. It has been said that occupational therapy is based on the mental mechanism that permits but one idea to occupy the focus of attention at a given time, and this factor is particularly valuable in the treatment of patients with skin diseases. Hammering a piece of copper (Fig 226) into a beautiful and useful bowl or ash tray (at the same time unconsciously hammering away some of the feelings of resentment against the world) can divert the attention of the dermatological patient.

Occupations which are mainly diversional may be chosen in accordance with the patient's interest and desires, keeping his background, occupation, and experience in crafts, or lack of it, in mind. The chief purpose is to arouse the patient's interest in something constructive within his physical limitations, but sufficiently complicated to require concentration on the work being done rather than on the illness.

Patients with chronic ulcerative colitis have benefited from occupational therapy. This disease may be influenced by psychological factors. At the

beginning of occupational treatment it is well to suggest small, uncomplicated projects which require a minimum of strength, which satisfy the patient, which evoke expressions of admiration on the part of others, and which can be completed quickly. It is necessary to keep the patient continuously supplied with new ideas, building up on the processes learned in the earlier projects if he does not of his own accord undertake a more complicated program. However, he should not be encouraged to attempt anything beyond his abilities. Any feeling of discouragement must be avoided.

What has been said about occupational therapy in specific medical conditions may be applied to most general medical patients. Diversional occupational therapy is also beneficial to surgical and orthopedic patients, both preoperative and convalescing. It is often possible to calm an apprehensive and un-co-operative patient during the days of observation before his operation, by providing him with suitable occupations. Sometimes, small projects are of greatest value, but when there is to be a long postoperative period in bed, it is advisable, when possible, to start a project which the patient will be able to work on during his convalescence. For instance, when a patient admitted to a hospital for a thoracotomy is ambulatory for a few days before the operation, as is frequently the case, he may be taken to the occupational therapy shop, where he will be in a cheerful busy work-room, filled mainly with convalescing patients. Here he may get his first lesson in woodworking, constructing a small wooden frame to be used for holding a knotted belt (Figs. 227 and 228). He may even get his first lessons in tying a square knot and then a series of square knots which will eventually become a colorful, attractive belt. He will take the frame back to his room with him after the shop period is over and instead of worrying about the impending operation, will concentrate his energies on remembering the knots he has learned and trying to keep a regular tension so that the edges of the belt will be straight. He may even get to the point of working out new designs. After his operation, instead of holding his arms carefully at his side to avoid the pain which accompanies any movement, he is shown how to pull his cords so as to obtain maximum elbow flexion and extension and shoulder abduction and adduction.

Most surgical and orthopedic patients benefit by having some occupation while they are confined to bed; it not only helps to relieve the boredom and tedium of waiting for bones and tissues to heal, but prepares the patient for the later occupations especially selected for the exercise given a particular part. The same patient who was given cord knotting for exercise while still in bed will use the elements of woodworking which he learned making

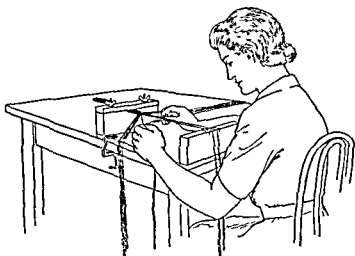

FIG 227 Belt made of cords, tied into square knots Requires concentration and results in a useful end product. Excellent for finger flexion

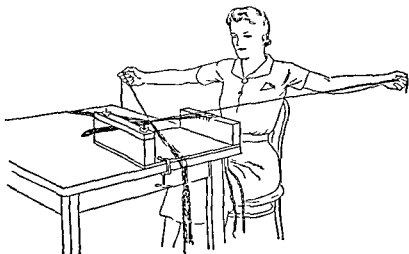

FIG 228 Cord knotting is adaptable. Most motions involving the upper extremities can be achieved. The exercise obtained depends on the way the cords are handled.

his knotting frame, in later treatment. When he first returns to the occupational therapy shop, he may not be very strong and his efforts should be confined to light work. At first, he may make wooden toys or another knot-

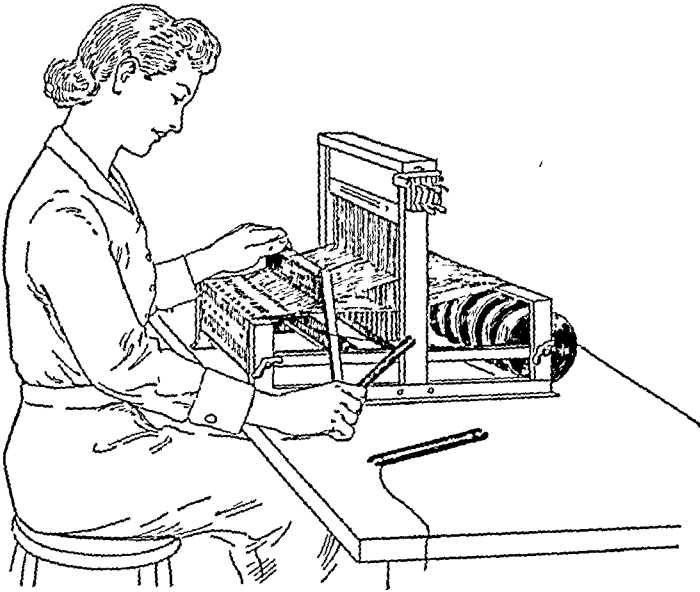

FIG. 229. Weaving on a table loom. A variety of motions can be secured depending on the way the equipment is used. Finger and wrist flexion, elbow flexion and extension, and shoulder abduction can be obtained.

ting frame, either for a friend who has become interested in the making of knotted belts as a hobby, or for other patients who are confined to their beds and are not able to come to the workshop. Later, as his strength increases, he is given other crafts, such as weaving at a loom similar to the one shown in Figure 229. A large loom of this type, using heavy materials, will appeal to a man and at the same time provide the desired exercise. If he prefers woodworking, this, too, will provide the right kind of activity; it can be carefully graded by giving him progressively heavier wood to handle, and larger surfaces to work. The patient achieves a triple satisfaction: he has used his time constructively in making a number of worth-while, useful and attractive articles; he has learned many new things; and, most important, has regained the use of his arm, shoulder, and back muscles.

In prescribing occupational therapy as a form of curative exercise, the physician should bear in mind that an ingenious therapist can provide an occupation producing almost any desired motion. Most of the equipment used is adjustable to the needs of various conditions, and in many cases, therapists have adapted or invented equipment for a particular need. The physician should be specific about the motion desired, and should indicate

the amount of treatment the patient is to receive. The therapist should keep records of the amount of joint motion at the beginning of treatment and of the improvement as the treatment progresses. The regular use of the arthrometer with accurate diagrams showing the improvement in motion will encourage the patient and show both the therapist and physician what physical results are being achieved.

The older ideas that the most effective treatment demanded complete rest of an injured part, followed by attempts at restoration of function after a long period of healing, has given way to belief in early, progressive motion while the injured part is healing. This can be accomplished by carefully selected graded occupations, prescribed and supervised by the physician and administered by a well trained therapist. According to Shimberg, "physical occupational therapy is a mixture of muscle exercise and work psychology." Restoration of physical function will cause a certain amount of pain, but when a patient's interest is centered on a diverting occupation, he is much less conscious of the pain than when the joint is forcibly moved for him by another person. Movement of the injured part during the healing process not only produces better function in a shorter time, but often prevents limitation of motion due to adhesions and contractures. The increased circulation accelerates healing. The importance of the early use of occupational therapy cannot be stressed too highly. Workers at Bellevue Hospital in New York City have achieved excellent results by early use of occupational therapy in surgical cases. On one surgical division, during one year, 612 of a total of 843 patients with fractures were referred to the occupational therapy department for functional restoration. Exercise was prescribed as early as possible, as a general rule, ten days after a Colles' fracture, or fracture about the wrist, and two or three weeks after a Pott's fracture, or fracture about the ankle. The patients reported for treatment three times a week and during each visit they received three work periods, alternating with rest periods. Work periods varied from three to ten minutes, stopping just short of fatigue. The work periods were increased and rest periods decreased as the patients improved.

In a study made in 1942 at the University of Maryland Hospital in Baltimore, Miss Nancy Valliant found that the amount of physical restoration achieved in fracture and joint injuries was in inverse ratio to the length of time allowed to elapse between the time of injury and the beginning of occupational therapy. The shorter the period between the injury and the beginning of active exercise, the higher the percentage of patients discharged as cured or improved.

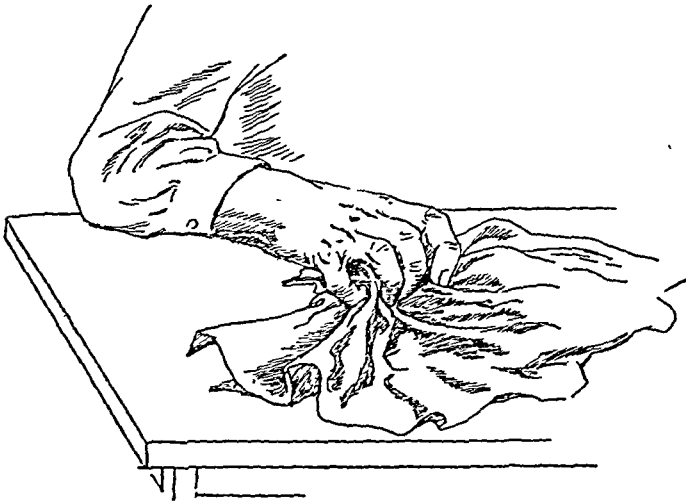

FIG. 230. Paper crumpling for finger flexion and extension. Towels may be used instead of paper if a material providing less resistance is desirable.

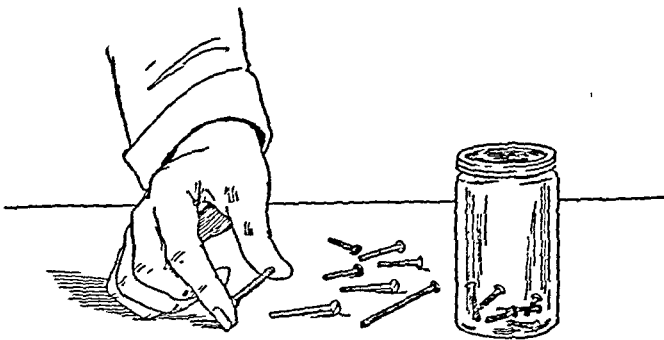

FIG. 231. Picking up bolts of assorted sizes for finger approximation.



Thus, at the risk of seeming repetitious, we emphasize the importance of early movement. As soon as the surgeon decides that the injured member can be moved, he should refer the patient for graded, active exercise.

When a trained therapist is available, either in an institution or in private practice, patients may be referred to her. If none is available, suggestions for curative exercise must be given to the patient. Apparatus suitable for home use should be recommended, his exercises should be closely supervised and his joints measured regularly to ascertain the amount of progress that is being achieved. The dual value of focusing the patient's attention on his occupation, rather than on his injury, and at the same time achieving the desired exercise, is recognized by leading authorities in the field of physical medicine. Dr. Harry E. Mock, formerly chairman of the Council on Physical Therapy of the American Medical Association, said "Many a patient in whom my reconstructive operation has been successfully performed and to whom well directed physical therapy has been applied has failed to respond to such treatment until his interest has been aroused and his ambition renewed by occupational therapy."

Many simple forms of exercise can be carried on at home, with little or no special equipment. A few suggestions will indicate what can be utilized and what may be valuable to the physician in prescribing occupational therapy. Crumpling first a towel, and later a newspaper, taking in the entire sheet by degrees, as in Figure 230, provides finger extension and flexion, especially valuable in cases of Colles' fracture. Thumb and finger approximation may be improved by having the patient pick up bolts with the injured hand, starting with fairly large objects and working with progressively smaller ones as the muscle action improves (Fig. 231). Sometimes, it may be necessary to reverse the usual order of a series of craft processes to achieve the desired degree of exercise. For example, a patient may not have enough muscle power to cut a linoleum block, as shown in Figure 232 (though this task is made somewhat easier by warming the linoleum with a slightly heated electric iron before carving, but he will be able to roll out the printing ink on a sheet of glass or metal placed at an angle which will (while keeping the elbow fixed) afford a good means for wrist palmar flexion and dorsiflexion (Fig. 233). After the ink has been rolled to the proper consistency, the glass is removed, the carved block (made by another patient when necessary) is substituted, and more exercise is obtained in applying the roller to the raised portions of the design. When the block is inked it is inverted on the paper or cloth and the patient, still with elbow fixed, prints the design on greeting cards, book plates, or on a table mat, further strength-

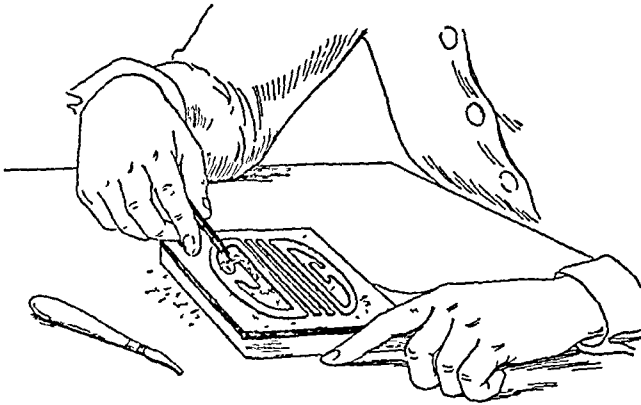

FIG. 232. Block printing. Cutting linoleum block gives finger flexion and palmar flexion and dorsiflexion of the wrist.

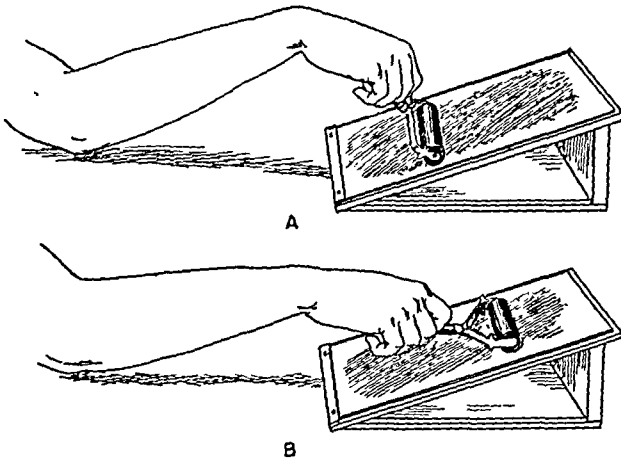

FIG. 233. Block printing. Rolling printing ink on an inclined plane, providing palmar flexion and extension of wrist.

ening the flexors and extensors of his injured wrist (Fig 234) When these muscles are strong enough, he can cut a block for his own use, or for the use of another patient

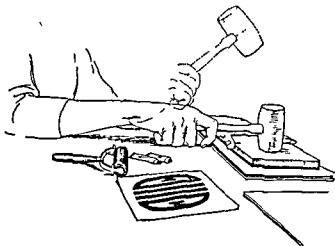

FIG 234 Block printing Printing the block provides dorsiflexion of wrist By changing the angle at which the arm is held, palmar flexion is obtained

Hammering a coaster, ash tray, or larger bowl will aid in developing these same muscle groups, so that variety may be given the patient to encourage his interest (Fig 226) Metal work is a very adaptable craft, the thickness of the metal and kind used (soft as with pewter, more resistant, as with copper), the weight of the hammer (from a light wooden mallet to a heavy jeweler's forming hammer), and the size of the handle (which can be built out so as to accommodate fingers which cannot grasp a small object), all are adaptable to the needs of the individual patient and can be gradually changed as his treatment progresses

Reed basketry is a traditional standby in occupational therapy and is still used a good deal It is valuable for patients with mental disorders because it requires few tools, and for patients requiring exercise because it is easily graded and varied Woodworking also provides many easily controlled motions Finger flexion, palmar flexion, and dorsiflexion of the wrist, and elbow flexion and extension can be obtained with sawing, using a light coping saw as in Figure 235 or a large rip saw as in Figure 236 The wood may be thin and soft at first, the thickness and degree of hardness gradually increased Sanding a curved surface with sandpaper wound around a section of broom handle (Fig 237) is good for wrist palmar flexion and dorsiflexion The ends of the stick may be built out with adhesive tape, clay or wax, to suit the individual patient As the amount of elbow and shoulder exercise obtained is determined largely by the patient's position in relation

to his work, maintenance of a favorable posture is of great importance. This is a factor which must be closely watched by the person supervising the patient's work—be it therapist, physician, nurse, or some member of

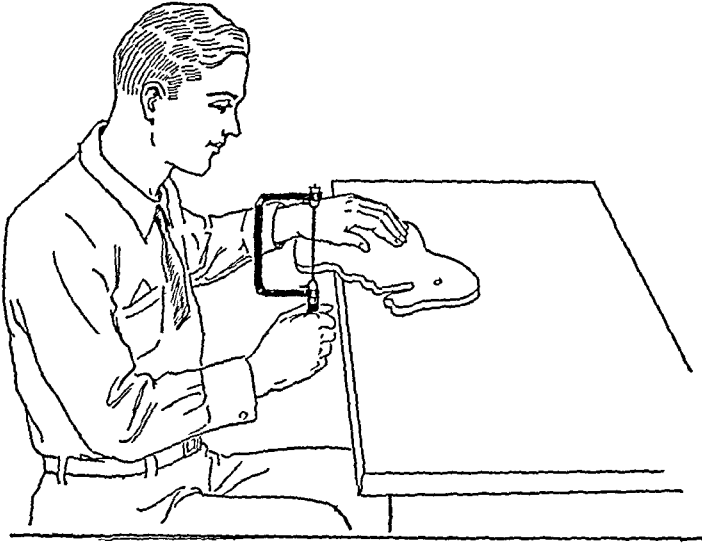

FIG. 235. Coping saw used to cut thin wooden toys provides finger flexion, palmar flexion and dorsiflexion of the wrist, and elbow flexion and extension.

the patient's family who has been instructed by the physician. It is human nature to "favor" an injured arm or leg, and most patients involuntarily find "easy" ways of doing their appointed tasks, in order to ward off the pain which accompanies exercise done in the prescribed way. The patient should understand that after an injury, some pain is a necessary accompaniment to the achievement of good joint function. In sawing, planing (Fig. 238) or sanding (Fig. 239) wood, the position of the material should be carefully adjusted to the requirements of each patient. To provide proper shoulder exercise it may be necessary to elevate a woodworking bench on blocks; for sawing or sanding it may be advisable to clamp a board at a height that would seem ridiculous to a carpenter. The primary purpose, the achievement of as normal a joint as is possible, must never be lost sight of, even though the craft processes are slowed up thereby.

Many crafts which at first glance seem purely diversional are also of value in physical restoration. Weaving, one of the oldest crafts known to man, is among these. A simple wooden frame for making mats is helpful for shoulder and elbow exercise. An adjustable rug frame for braid-weaving, and a circular frame for wheel weaving, both of which can be raised and lowered as necessary, provide for finger extension as well as for shoulder abduction (Figs. 240, 241). These weaving frames are valuable in the care



FIG 236 A large saw allows motion of the entire upper extremity, particularly of the elbow and shoulder

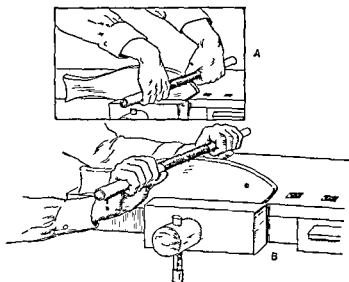

FIG 237 Sanding curved surfaces for (A) palmar flexion, and (B) dorsiflexion

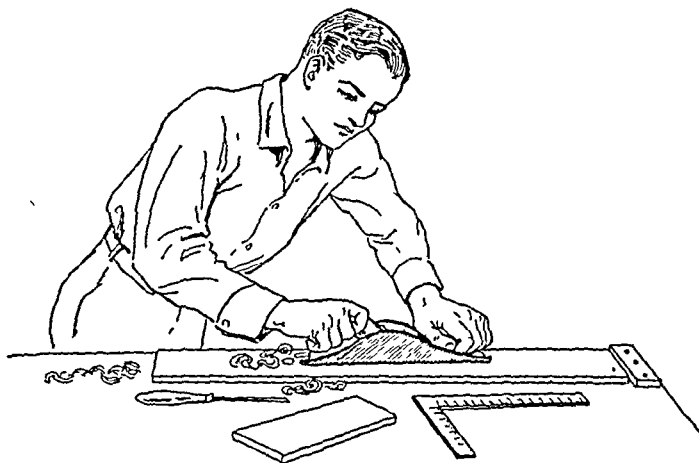

FIG. 238. Planing long surfaces is valuable for elbow and shoulder flexion and extension and for the upper extremity as a whole.

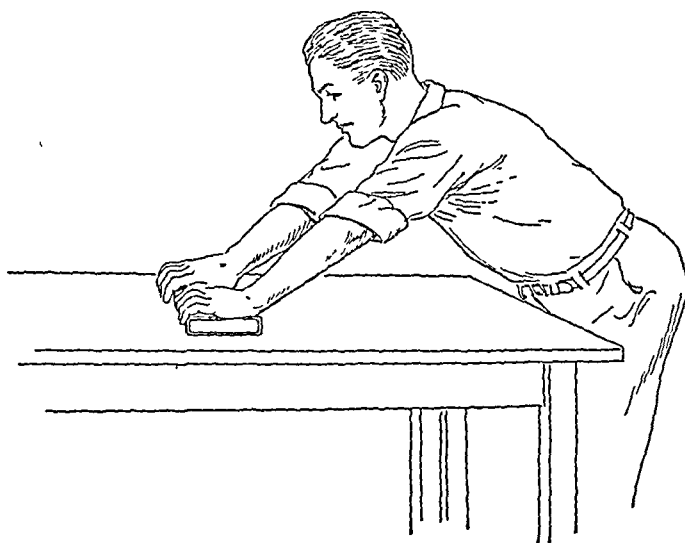

FIG. 239. Sanding, with the sandpaper fastened to wooden blocks of various sizes, is an easily adapted process to provide different kinds of motions for the fingers, wrists, elbows, and shoulders.

of arthritic patients and for muscle re education after mastectomies Table looms like that shown in Figure 229 provide finger exercise in manipulating the levers which raise and lower groups of threads, and in using the beater to which weights can be attached to provide greater resistance Elbow flexion and extension and shoulder abduction can be obtained by having the patient work with a long length of thread unwound from the shuttle This will necessitate moving the hand far out to the side to draw the thread firmly Weaving on a large floor loom with coarser materials provides heavier exercise, when desired, and also knee and ankle flexion

Motions of the lower extremity can also be obtained with a bicycle saw (Fig 242) This apparatus may be adjusted as required, and the material varied the distance between the pedals from the seat and the height of the seat may be changed Different thicknesses and kinds of wood may be used An old fashioned treadle sewing machine provides excellent ankle flexion and extension (Fig 243) If the patient is a man, and prefers not to sew, this same action can be utilized by substituting for the sewing mechanism wheel brushes and buffers

With children, the value of exercise in which there is an "interest" element present can hardly be overestimated Finger painting, previously mentioned for its value as a diversional occupation, is also useful as a restorative exercise for fingers, wrists, elbows, and shoulders The angle at which the work table is adjusted, and the kind of motions encouraged (small for finger and wrist exercise, large, sweeping motions for elbow and shoulder movement) will determine the benefits derived from this occupation Drawing on a wall blackboard aids in developing co-ordination Drawing or writing, first with large, thick crayons, then with progressively smaller ones, is helpful in re education of finger muscles The playing of simple musical instruments, like those used in rhythm bands, games requiring the use of peg boards or large checkers or chessmen, all are helpful Games also provide therapeutic exercise for adults Ping pong, archery, croquet, tennis, golf, and many other sports provide specific exercise, and should not be overlooked by the physician The patient's attention may be called to the exercise involved in the performance of ordinary personal or home activities, such as combing the hair, walking up or down stairs, polishing shoes or silver, making beds, sweeping, typing, rowing, and so on These, however, may not be adequate The patient with chronic arthritis, for instance, is likely to perform these acts poorly in order to avoid pain as much as possible Whenever possible, the physician should arrange for regular supervised exercises

From the point of view of occupational therapy, arthritic patients may be

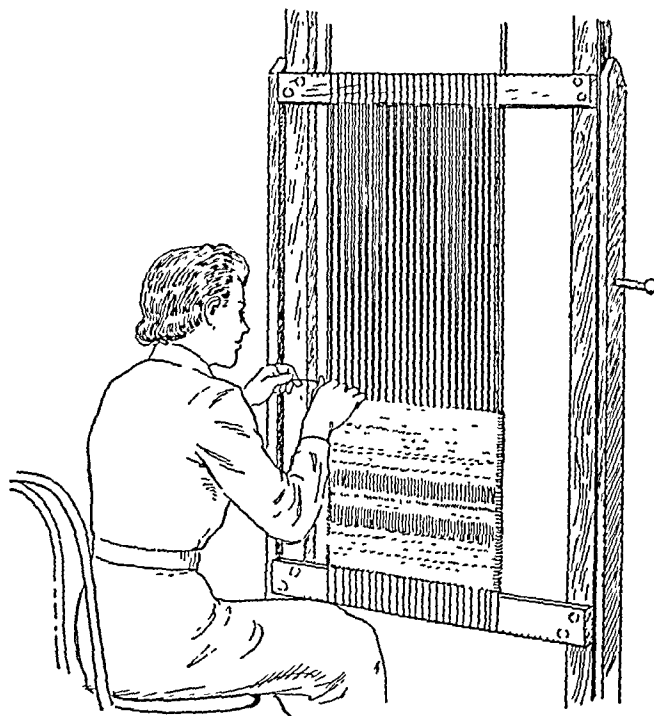

FIG. 240. Braid weaving of small rug on an adjustable upright loom. Especially valuable for arthritic patients and for patients recovering from mastectomy. Flexion and extension of the fingers; palmar and dorsiflexion of the hand; and shoulder elevation can be achieved.

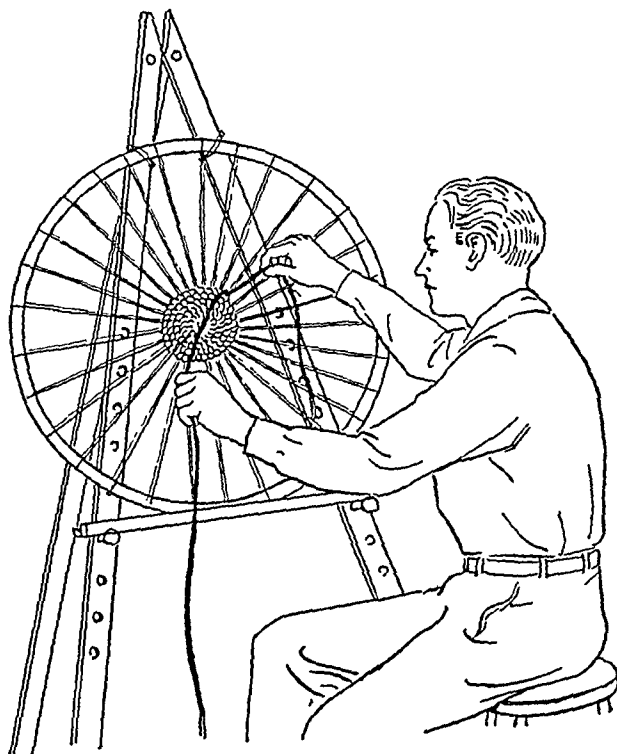

FIG. 241. Wheel weaving is easily adapted for bed and ambulatory patients. Elevation and circumduction of the shoulder joint and finger and wrist exercises are provided.



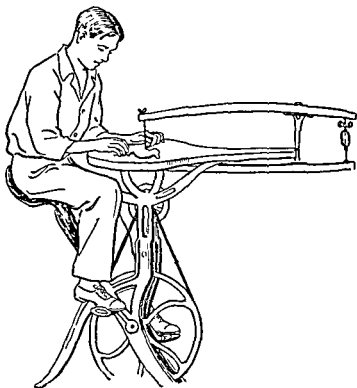

FIG 242 Bicycle jigsaw encourages flexion and extension of hip knee and ankle Saw cuts on both forward and backward pedaling

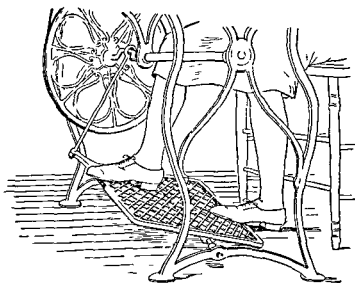

FIG 243 Treadle sewing machine used for ankle flexion

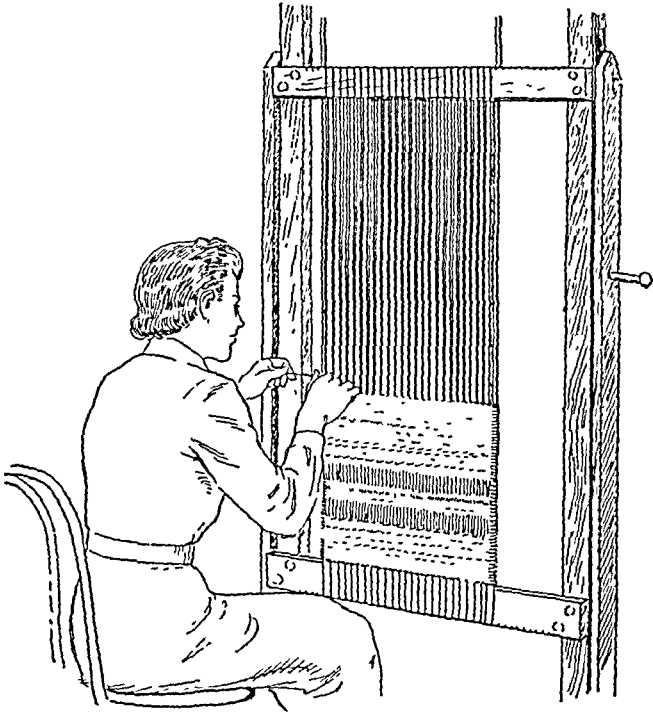

FIG. 240. Braid weaving of small rug on an adjustable upright loom. Especially valuable for arthritic patients and for patients recovering from mastectomy. Flexion and extension of the fingers; palmar and dorsiflexion of the hand; and shoulder elevation can be achieved.

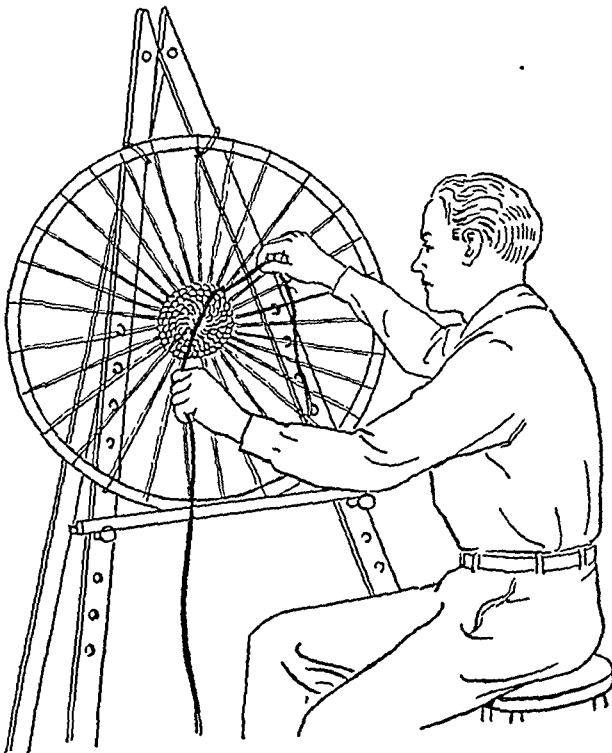

FIG. 241. Wheel weaving is easily adapted for bed and ambulatory patients. Elevation and circumduction of the shoulder joint and finger and wrist exercises are provided.

- 2 Weaving on built up floor loom
- 3 Braid weaving
- 4 Basketry with tall spokes

#### B Flexion

- 1 Knotting
- 2 Weaving
- 3 Braid weaving
- 4 Woodworking
- 5 Printing on hand press

#### C Abduction

- 1 Knotting
- 2 Weaving
- 3 Braid weaving
- 4 Basketry
- 5 Leather lacing

#### D Circumduction

- 1 Winding wool
- 2 Wheel weaving

### II Elbows

#### A Flexion

- 1 Basketry
- 2 Weaving
- 3 Knotting
- 4 Leather work
- 5 Needle work
- 6 Woodworking
- 7 Winding yarn
- 8 Coping saw projects

#### B Extension

- 1 Hammering
- 2 Basketry
- 3 Weaving
- 4 Knotting
- 5 Braid weaving
- 6 Coping saw projects
- 7 Woodwork, planing

#### C Pronation

- 1 Needlework (petit point)
- 2 Weave it squares
- 3 Crocheting
- 4 Braiding

divided into two main groups: (1) those in the acute or chronic stage of the disease, whose joint function can be restored either wholly or partially, and (2) those who have suffered from the disease for many years and in whom there has occurred destruction of joints or cartilages. While normal function cannot be restored to patients in the latter group, occupational therapy is useful in preventing further impairment, in preserving the joint motion that remains, and, in some cases, in increasing motility. In infectious arthritis, occupational therapy should not be instituted until all acute symptoms have subsided; thereafter carefully graded occupations may be administered for very short periods in an effort to prevent adhesions. Hypertrophic, or osteo-arthritis, usually results in muscle spasm with mechanical limitation. Here again, occupational therapy should not be prescribed until the muscle spasm and pain have subsided, and then, only in carefully graded doses. In atrophic arthritis, however, occupational therapy should be employed as early as possible. In all work with arthritic patients, overexercise must be guarded against; danger signals are increase in swelling, heat, or redness; persistent pain, lasting over three hours; or a rise in temperature.

Occupational therapy is particularly valuable in the treatment of arthritis because it can so easily be adapted for use in the home, since complicated equipment is not a requisite. Most arthritic patients are ill a long time, but few are hospitalized, and therefore carefully graded and supervised home activities can be of great value in overcoming joint disabilities. According to Swain, "Occupational therapy has its largest application in arthritis for the following reasons: The work can be made to produce every known movement of the body; it can be graded to any desired effort; and can be controlled. But, best of all, its effects can be charted and measured with considerable accuracy, so that at any time the worker can judge the results on the patient."

In discussing occupational therapy for physical disabilities, particularly those caused by arthritis, Kuhns says: "There is no one craft for a single disability. Combinations are often desirable. It depends frequently on the patient's personal inclinations and upon the materials at hand. Many of these crafts can be carried out in the home if they can be supervised by a competent individual. A hospital or special tools are not essential." The following is an abbreviated list of crafts for special motions in the different joints, as suggested by Kuhns.

## I. Shoulders

### A. Elevation

#### 1. Knotting

## IV Fingers

## A Metacarpophalangeal joints

## 1 Flexion

- a Paper cutting (scissors)
- b Puppets
- c Cutting linoleum blocks
- d Basketry
- e Weaving
- f Knotting
- g Leather lacing
- h Link belts
- i Needlework

## 2 Extension

- a Finger painting
- b Block printing
- c Pottery, coil method
- d Braid weaving
- e Knotting

## V Hip

## A Flexion

- 1 Bicycle jigsaw
- 2 Floor loom

## B Extension

- 1 Jigsaw
- 2 Floor loom
- 3 Potter's wheel (kick type)

## C Abduction

- 1 Weaving on floor loom
- 2 Organ, where available

## D Adduction

- 1 Weaving on floor loom

## VI Knee

## A Flexion

- 1 Bicycle jigsaw
- 2 Floor loom

## B Extension

- 1 Bicycle jigsaw
- 2 Floor loom
- 3 Potter's wheel (kick type)

## D. Supination

1. Weave-it squares
2. Crocheting
3. Needlework

## III. Wrists

## A. Dorsiflexion

1. Block printing
2. Pottery
3. Wood carving
4. Linoleum block cutting
5. Wood turning on a lathe
6. Wrought-iron work
7. Weaving
8. Braid weaving
9. Hooking
10. Knotting
11. Bookbinding
12. Tatting
13. Printing on hand press
14. Knitting

## B. Palmar flexion

1. Basketry
2. Wood carving
3. Linoleum block cutting
4. Weaving
5. Braid weaving
6. Tatting
7. Bookbinding
8. Hooking

## C. Ulnar deviation

1. Knotting
2. Basketry
3. Knitting
4. Bookbinding
5. Hooking
6. Weaving

## D. Radial deviation

1. Knotting
2. Knitting
3. Weaving
4. Bookbinding
5. Hooking

of the therapist during this difficult period. In his book, "Prescribing Occupational Therapy," Dunton has listed the following factors in the prescription which he gives the therapist:

1 The object to be attained. Do we desire mental rest, physical rest, exercise of a particular part of the body, cultivation of some mental habit, or change of mood?

2 The type of occupation which will best serve the object desired. This does not mean the physician should specify the craft or occupation to be given, but should indicate whether it is to be soothing and quiet, or stimulating and vigorous.

3 Contraindications which may influence the choice of occupation.

4 Precautions necessary, such as the avoidance of cutting tools in the case of one with suicidal tendencies, the danger of fatigue in neurasthenia, tuberculosis or cardiac disease, and the danger of overexertion in orthopedic cases.

It is the physician's responsibility to give adequate information on these factors to the therapist and to keep himself informed as to the manner in which the prescription is being filled. It is advisable to let the patient know that the doctor is interested in this part of his treatment. Occupational therapy is but one of many agencies for treatment which are at the disposal of the physician. In hospital practice it must fit in with other treatment regimes such as the nursing care of the patient, social service and physical therapy. Each of these services has its own part to play in the recovery of the patient. The nurse takes care of the physical and medical needs of the patient as ordered by the physician. The medical social worker aids in solving the patient's personal problems, in adjusting the family to the individual's illness, and in putting the patient's mind at ease so that he is in a position to benefit from the medical care given him. The occupational therapist acting in co-operation with the doctor, the nurse, and social worker carries out the doctor's orders for occupational therapy whether for diversion or exercise. She does so after she has learned all she can about the patient from the nurse and social worker, both of whom are well qualified to aid the therapist in this way. It has been found that a few minutes spent in consultation with the nurse and social worker before beginning occupational therapy and at intervals during the course of treatment are valuable in establishing a better understanding of the patient's needs, thus enabling the latter to derive maximum benefit from this part of the cure.

An especially close relationship exists between physical therapy and occupational therapy, since in large numbers of cases these departments work together for the physical restoration of the patient. Often, the treatments are co-ordinated, physical therapy preparing the injured part for the voluntary,

## VII. Ankle

## A. Dorsiflexion

1. Sewing machine
2. Lathe
3. Spinning wheel
4. Floor loom
5. Potter's wheel
6. Piano or pump organ

## B. Plantar flexion

1. Sewing machine
2. Lathe
3. Spinning wheel
4. Floor loom
5. Potter's wheel
6. Piano or pump organ

Nowhere is a graduated program of activity more important than in the rehabilitation of the tuberculous patient. Carefully prescribed occupational therapy helps to increase the patient's strength and serves as an indication of his work tolerance. Tuberculosis sanatoria often provide re-education as well as treatment; they can improve the general education of the patient, and help the development of hobbies. In some institutions, aptitude tests are given and suitable vocational training made available so that on recovery the patient is enabled to do work within his physical strength; the study of foreign languages, mechanical drawing, shorthand, business methods, and photography are all lines of endeavor which are suitable for patients with an arrested or cured tuberculosis condition.

There are other patients such as those suffering from industrial accidents, and the newly blinded whom it is also necessary to aid in their adjustment to a new way of life. When a patient knows that it will be impossible for him to return to his former occupation, his illness brings him more problems than most persons are able to cope with alone. However, occupational therapy chosen for the purpose of proving to him that he can still accomplish many things, will often help the patient's morale during his convalescence, and also teach him to make maximum use of his faculties. When, on discharge, the patient is referred for vocational rehabilitation, he will have regained good working habits and his personality traits and abilities will have been studied and reported to the rehabilitation worker. The patient now enters on a new phase of his life, preparing for a new occupation, with a much more receptive mind than if he had not had the help and guidance



Body and spirit inextricably conjoined To heal the one without the other is impossible If a man's mind, courage and interest are enlisted in the cause of his own salvation, healing goes on apace, the sufferer is remade, if not, no mere surgical wonders, no careful nursing, will avail to make a man of him again Therefore, I would say 'From the moment he enters the hospital, look after his mind and his will, give him food, nourish them in subtle ways, increase that nourishment as his strength increases Give him an interest in his future'

"A niche of usefulness and self respect exists for every man, however handicapped, but that niche must be found for him To carry the process of restoration to a point short of this is to leave the cathedral without a spire"

## REFERENCES

- DUNTON, W R, Jr Prescribing Occupational Therapy Springfield, Ill, Thomas, 1928
- KUHNS, J G, and STEINBROCKER, O Arthritis in Modern Practice Philadelphia, Saunders, 1941
- MOCK, H E Reconstructive surgery and functional restoration In Principles and Practice of Physical Therapy Hagerstown, Maryland, Prior, 1932, Vol II, Chap 1
- MOLANDER, C O Therapeutic exercises in surgical conditions In Principles and Practice of Physical Therapy Hagerstown, Maryland, Prior, 1932, Vol III, Chap 14
- PATTISON, H A The trend of occupational therapy for the tuberculous *Arch Occup Therapy*, 1 19, 1922
- SHIMBERG, M Occupational therapy in orthopedic surgery *Occup Therapy* 15 154, 1936
- SLAGLE, E C Syllabus for Training of Nurses in Occupational Therapy Utica, New York, State Hospitals Press, pp 11-12
- SWAIN, L Does occupational work hasten recovery of the crippled? *Mod Hosp*, 27 97-98, 1926

active use and exercise which is provided through occupational therapy. Molander said: "It is evident that the occupational therapist cannot prepare the injured member for activity, and that the physical therapist finds the greatest limitation in the psychologic elements. The interest, therefore, which occupational therapy offers is not present in physical therapy. Enough interest and incentive are provided in occupational therapy to make the patient exercise, and the attention is not focused on the disability as it is in physical therapy."

In her "Syllabus for Training of Nurses in Occupational Therapy," Eleanor Clark Slagle, director of the Bureau of Occupational Therapy of the New York State Department of Mental Hygiene, outlined the following aims and purposes of occupational therapy:

*To reconstruct, to rebuild, or re-educate the patient*

A. *Mentally*

1. Arouses and develops attention.
2. Creates new interests.
3. Gives an opportunity for self-expression.
4. Eases emotional stress.
5. Gives an outlet for repressed energy.
6. Substitutes encouragement for discouragement.
7. Replaces unhealthy mental trends with healthy ones.
8. Has a normalizing influence—it's natural for man to be occupied.
9. Conserves the work habit and prevents invalid habits.

B. *Physically*

1. Restores function to disabled joints.
2. Renews wasted nerve and muscle tissue.
3. Increases blood supply and healing processes.
4. Builds up resistance fatigue.
5. Develops mental and physical coordination.

C. *Socially*

1. Raises morale of patient, ward and hospital.
2. Develops group responsibility and cooperation.
3. Gives opportunity for social contacts in normal activities.

To achieve these aims is the responsibility of the occupational therapist. The results are well worth the energy expended in their pursuit.

John Galsworthy stated these aims in another way: "Restoration is at least as much a matter of spirit as of body, and must have as its central truth:

and unorganized Through his knowledge of the patient's social and educational history and interests he has offered vocational advice based on general rather than specialized knowledge

Rehabilitation should begin as early in convalescence as the course of the disease will permit, but too often in the past a well intentioned caution on the part of the physician has delayed its commencement beyond the point of maximal advantage The institution of rehabilitation has therefore varied markedly with respect to the duration and individual variations of the disability During the past few years there has been increasing emphasis on the "abuse of rest" Much has been written about the early use of pulmonary ventilation following atypical virus pneumonia, physical exercise following heart disease and rheumatic fever, and the shortening of the period of bed rest following surgery All these reports have been enthusiastic but the profession has been slow to accept them Although the value and importance of early mobilization following acute disease is still debatable there is no question about the need for early rehabilitation of permanent disabilities

In a general way it can be said that the gradient of energy expended by the patient in physical activities must increase with the passage of time and that this progress will be reflected in a gradual easing of the psychological adjustments to the new difficulties of the patient

#### COMMON DENOMINATORS

Although the varieties of disability are legion and each must be considered separately, there are many features of approach common to all types of medical rehabilitation The first and most important of these is psychological management The shock of any sudden disability is increased by the new leisure time available for nurturing mental depression Depending upon the extent of the disability and the mental development of the patient, any reaction from simple unhappiness to severe psychoneurosis is possible This can be attacked only by properly trained personnel who are willing and able to devote their energy and skill to combatting the mental manifestations of disability Every member of the rehabilitation team must be selected for his ability to be persuasively cheerful and understanding The team ideally includes a physician, nurse, physical therapist, occupational therapist, psychological counsellor, vocational guidance counsellor, social worker, and recreation director The psychological problem also demands a community of patients with similar disabilities, inasmuch as the distribution of schedules can then be such as to lend encouragement to the newer patients through their observance of the progress of the older patients

The second phase of medical rehabilitation includes the use of those modal-

## CHAPTER XIV

# MEDICAL REHABILITATION

BY SIDNEY LICHT, M.D.

**D**URING RECENT YEARS THE IMPORTANCE OF THE period following disease has increased greatly. The evaluation of treatment during follow-up visits led to increased emphasis on convalescent care. As a direct outgrowth of this attention, and, even more, as a result of the experiences of World War II, the problem of rehabilitation or the return of the patient to gainful community life has assumed major proportions. Medical rehabilitation will increase in importance with the passage of time if for no other reason than that it will eventually save the community and the state much money which would otherwise be spent in unemployment benefits, insurance compensation, and custodial care.

Medical rehabilitation is a concept of treatment which combines medical, psychological, educational, and sociologic methods to give the disabled patient maximum independence commensurate with his limitations. Independence stems from psychological and physical readjustment to the situations which the individual will encounter on his return to his family, community, and job. For the patient it is the mastery of new methods which must be substituted for impaired or lost capabilities. For medicine it is the organization of a team of professional workers whose integrated efforts will complete the mission most economically. Medical rehabilitation is prescribed training.

Rehabilitation like physical medicine is concerned with all disabling pathology, and because it so often seems a continuation of the practices of physical medicine and has become so closely allied with it in hospital procedure, a discussion of it seems fitting in a book of this kind. Its scope is so wide that it will be treated here in outline form, especially since few physicians will engage in more than its supervision, but the physician can do much for his patient by an appreciation of its many facets and a general knowledge of its prescription and execution.

The family physician has always given his patients guidance and care directed towards rehabilitation but for the most part it has been informal

erence to famous people who have overcome similar handicaps and to patients recently discharged should be made. Discharged patients should be encouraged to return with personal evidence of achievement and adjustment.

Any and all methods of increasing happiness should be employed. The importance of diversion and entertainment to bolster morale has not been given sufficient emphasis until recently. All forms of entertainment whether passive or active must be employed to fill out those hours of the day not devoted to treatment, rest, or training. Music, motion pictures, the radio, games, and hobbies must be readily available with regularity and in abundance.

Patients must be made to feel that they are a part of the rehabilitation community and that they will one day fit into their new community. They must be encouraged to do as much for themselves as possible in such fields as personal hygiene, appearance, useful occupation, and minor institutional maintenance. There is usually something the patient can do a little better than his neighbor and if he is called upon to do it, it will increase his self respect, particularly if he does it moderately well. If he cannot he should be asked to perform some other assignment. Criticism must be private. Praise should be public. Nothing succeeds like success and every advance must be praised sincerely but casually.

Contacts with friends and relatives are important not only for the security and joy occasioned by familiar faces but as a token of the community life to which he wishes to return. His new world is his institution, but he would rather have the old world, and such visits or even letters strengthen the bridge over this gap. Visitors must be oriented to recognize and appreciate minor improvements, and to omit references to any subjects which might diminish the patient's happiness. When the patient has progressed to the point where it becomes safe for him to visit his home this should be expedited. It will be a welcome change. It will give him an opportunity to try out some of the new things he has learned outside the institution. He will usually be a happier patient when he returns.

Inasmuch as the chief aim of rehabilitation is a return to a more normal status, the patient must be treated with as much disregard of his disability as safety and happiness will permit. Staring, exaggeration, and patronage are undesirable, and specific efforts towards their elimination or control should be instituted.

Those members of the family who cannot visit the patient must be oriented by the visiting social worker. One incorrect word or look at home may undo the prolonged effort of the rehabilitation program.

ties and activities of physical and occupational therapy designed to restore salvageable functions as well as to teach the patient to meet the physical demands of daily living. These are fully discussed in the preceding text and additional comments will be made under specific headings later in this chapter.

The third phase of medical rehabilitation is maintenance of physical fitness. All disabilities are accompanied by diminished physical activity. Even in conditions not affecting locomotion the imagined or real stigmata associated with the defect are likely to diminish contacts with people and the community and make life sedentary. A program of physical activity based on tolerance and ability must be encouraged early in convalescence. Physical directors especially trained to work in hospitals must employ their ingenuity in devising methods and equipment which will engage patient participation. Physical activity is closely allied to mental attitude and the increased use of the body will improve mental as well as physical hygiene.

The fourth phase of rehabilitation is a process of learning; first, to learn to do without, and second, to learn to do with what remains or what is added. The first is largely a matter of psychological adjustment, the second means tedious training in substitution procedures—to walk on the shoulder girdles, to hear with the eyes, to see with the fingers, or the use of mechanical aids.

The final phase of rehabilitation is vocational and includes an inventory of physical and mental capabilities (Vocational Testing), the correlation of capabilities with the important work factors of specified job requirements (Vocation Counselling) and the preparation for gainful employment in suitable positions (Vocational Rehabilitation) leading to job placement.

The therapeutic aspects of the major disabilities will be discussed under the appropriate headings, but a further consideration of the common denominators will be listed here as a guide to all who would perform rehabilitation work.

#### PSYCHOLOGICAL MANAGEMENT

The disabled person will react to his disability. He may not express or show the degree of his mental depression but it is better to assume a natural emotional change than to believe that his superficially happy status is genuine, because if it occurs promptly it is possible that he may adjust too well and he may lose the incentive for further improvement and be content to be a dependent invalid. Cheerfulness is a necessary qualification for all personnel involved in this work. All members of the rehabilitation team must refer to future possibilities of improvement whenever the occasion is opportune. Ref-

adviser, when based on examination and progress record, can bridge the gap between the impersonality of the hospital and the individual attention of the general practitioner

This is the essence of rehabilitation, and is a tedious phase which requires great patience on the part of the instructor as well as the patient. In most instances it is comparable to the training processes of the young child who must learn to walk, to speak, to coordinate, and to do many of the things a disabled adult must. It takes the child a long time because there must be a simultaneous development of mental associative processes. The adult usually has set cerebral patterns, and in a sense many of these must be unlearned to accept the new and to avoid confusion and the unnecessary acts which have become almost reflex. The chief aim of the teacher of new methods is to recognize fatigue and impending despair and to substitute rest, recreation, or a change so that the point of complete discouragement is not reached, because when it is reached, even though it may be conquered, it means not only a halt to progress but a setback in newly acquired skills.

#### LEARNING TO DO WITH WHAT IS ADDED

It has long been traditional for normal people to complain about the tightness of new shoes which have to be "broken in." If that is true of a standard shoe for a normal foot, we can hardly blame the disabled for their complaints about the discomfort of the new hearing aid, the ill fitting brace or prosthesis, the crutch or other appliance. Many of these items must be made to fit the individual. We are generally unconcerned about the proportions of our body, because it is not usual for the healthy busy adult to think about the physiology or mechanics of his anatomy. But when a part of the body is gone, when a part has to be fitted, comfort can be a matter of millimeters. We cannot compromise with comfort—it is the least we owe the disabled. The appliance maker must be as patient and exacting as every other member of the rehabilitation team. Appliances must fit and be comfortable. There is usually only one proper judge of this and the patient's reaction must be accepted as the guide.

#### VOCATIONAL REHABILITATION

Happiness for most people and especially for the disabled is intimately associated with earning capacity since it is the tool by means of which he can give others and himself the comforts and pleasures which can be purchased. It is also the source of better appliances and training. Maximum earning capacity is a major goal of rehabilitation. This means far more than the right job for any one patient, because job retention depends on far more than

## PHYSICAL FITNESS

Inactivity results in deconditioning. The muscles lose tone, the appetite diminishes, and the changed physical appearance as reflected in the mirror will result in further mental depression.

Exercise can be given to all convalescents but the need for it must be impressed upon each patient. Calisthenics is usually boring and apparently purposeless to many, and those who require it most are frequently the most difficult to convince. The physical director must have sales ability in addition to training in physical education.

Calisthenics should be begun while the patient is still restricted to bed. Where personnel allotments are adequate it may be given individually but group activity is usually more satisfactory because the occasional recalcitrant will join to remain part of the group.

Bed calisthenics, as all physical activity, should be progressive. Exercises should begin with motions in all directions of all the joints and areas from the neck down to the toes. Exercises should be varied daily.

Group calisthenics for ambulatory patients should be followed by those games which facilities permit. The use of designated outdoor areas properly marked and equipped is a great incentive to participation.

## LEARNING TO DO WITHOUT

Few if any ever really learn to do without, because no matter how well they adjust to their disability there are always some things they would like to do which they cannot, but the aim of rehabilitation workers must be to approach this goal. Among the methods used are comparative illustrations of physical accomplishments such as vicarious motions, tricks, or development of mental associations. Comparative illustrations include lists of famous persons who achieved or maintained their fame after acquiring a handicap equivalent to or greater than the one the patient has suffered. There are numerous recorded and available references to the famous blind, paralyzed, deaf, tuberculous, epileptic, and amputees. These are great morale builders in the early stages but their importance may diminish with time. Of equal importance eventually are the rehabilitated patients about to leave the institution and these same patients on their return visits to the hospital. It is well to dream of Homer, Roosevelt, Beethoven, Trudeau, Caesar, and McGonegal, but when Smith and Jones return with proof of a pay check and community acceptance, tangible evidence is available to the sceptic and the troubled. The family physician can play an equally important role when the disabled patient visits his office. The encouragement of an old and trusted



can be tested Viteles lists the following items which lend themselves to testing interests, competency, temperament, education, experience, mental ability in relation to energy, endurance, control, coordination, initiative, concentration, discrimination, memory, understanding, observation, planfulness, intelligence, intellect, judgment, logical analysis, language ability, and executive ability There are other factors which must be determined in an inventory of the patient's capabilities and they include the nature and restrictions of the disability (which must be furnished by the physician), the social and economic background (which can be determined by the social worker) and still other factors which need only be analyzed in relation to specific positions For instance, appearance would have to be considered for positions in the sales field

The psychologist who does the testing is called a psychometrist He records his findings on a graphic chart called a psychograph which offers him a personality pattern of the subject and an indication of the occupational field or fields most suitable for the subject To narrow the field still further, additional highly specialized tests can be administered From the results of these, the educational record, occupational and avocational experience, and the limitations of the handicap, the vocational guidance counsellor is able to suggest the next step which may be further academic study, in service training, or immediate placement

#### LOSS OF EXTREMITY

Except for the common denominators mentioned, the management of *partial amputation of one extremity and that of complete paralysis of two extremities* is sufficiently different to be considered separately Since an entire volume would be necessary to cover any one of these conditions only the highlights of the more common conditions will be related

#### PARAPLEGIA

Pathology of the spinal cord may result in a variety of clinical pictures not only as a result of the many possible causes but because of the different levels at which the cord may become involved Emergency treatment and initial surgical management may influence the later course of the patient whose disability was traumatic in origin For all patients rehabilitation must be begun as early as possible

*Early Treatment* Most important is instruction in self care The rehabilitation teamwork is most telling in this group Professional workers must not only work simultaneously but with much consultation and integration The nurse must give especial attention to the skin which, because of the concomi

skill; it also depends upon good work habits and community interest. Good work habits include personal hygiene and neatness, loyalty, punctuality, and thoroughness. Patients should be given specific training in good work habits and the occupational therapy aide is trained in this field. Interest in the community means the desire to help coworkers, to make friends and social adjustments, and the patient should receive training in courtesy, friendliness and his relation to employer and employee for better employment retention.

While at the hospital everything possible should be done to improve mental and physical health since the disabled needs these more than the able. This includes not only the diversions mentioned earlier but also calisthenics and educational talks. Above all these must be given with a regularity and purpose. The minority will exert themselves for additional education, but education is resisted by the average, especially when they are in groups. A rigid discipline is necessary and this must be an unalterable policy. It is better for the disabled to feel sorry for himself in relation to the taskmaster than to his handicap.

When labor is in great demand, few people willing to work experience difficulty in getting employment. The jobs for which they apply are usually those which pay the most for their potential or acquired skill. In ordinary times many workers seek any openings which will pay them a living wage without much regard to their adaptability to such jobs. Very often, the disabled worker will have to seek an occupation other than the one in which he was engaged prior to his disability. The thought of starting anew can be frightening. He knows too little about other jobs, especially in relation to his new limitations. During the past twenty-five years psychologists have developed an ever-increasing list of tests to determine the most suitable occupation for the individual. Some of these tests are questionnaires and some require manual operations. None is perfect and no one test will give enough information to successfully guide the applicant, but when the results of selected tests and questionnaires are analyzed by specially trained personnel it is usually possible to give the subjective vocational advice which, if followed, will lead to happy gainful employment. When the handicapped are given these tests in a hospital it is a change from routine and acts as that stimulation to the mind so beneficial to the bedridden. The patient may continue of his own free will to further analyze his capabilities and this activity may key him up to a growing desire for occupational training or further education. Similar tests can and should be given by the physician to the patient who is treated at home.

Before describing some of the tests it would be well to review some of the important characteristics which are concerned with employment and which

and is best begun with muscle setting. The instructor places his fingers or hand over the muscle area to be contracted and advises the patient to tighten the muscle under palpation. Such procedure must be repeated until the point of fatigue and each day an attempt must be made to increase the number of contractions and the period of exercise. After muscle setting has been mastered the instructor should progress to motion with gravity eliminated and finally to motion against gravity if possible, as described in Chapter XII.

The most important exercises are those which strengthen the muscles needed in crutch walking. As will be described under that procedure, the most important groups are the triceps, pectorals, trapezius, and rhomboids. The patient's bed should be equipped with a Stryker or Balkan frame so that he may move himself on the trapeze. In general, the muscles which lend mobility to the patient in bed are the antagonists of those needed in crutch walking. Bed motions on the trapeze exercise the biceps brachii. There is no harm in having strong biceps providing that they are not developed to the exclusion of the triceps. While in bed the patient must be instructed in the strengthening of the muscles mentioned, and with the firm mattress recommended for paraplegics, this is not difficult. The patient should be encouraged to push himself up rather than pull himself up.

Braces for the lower extremities should be ordered as soon as possible. Braces become a part of the patient. They become part of his security. They must fit properly, if pressure sores are to be avoided and if locomotion is to be encouraged. The psychological trauma of the disease makes the patient irritable and hard to please about any phase of his progress. If the braces are not properly fitted he will find a ready and valid excuse for regression.

*Ambulation* Getting out of bed is the chief aim of the paraplegic. This must be started at the earliest moment commensurate with the disease. The most serious deterrent to the ambulatory regime is the reflex motor spasm called the *mass reflex*. It may become so severe that rhizotomy may be indicated, but this should only be performed as a last resort. The patient should be placed in a wheel chair as the first step towards ambulation. The wheel chair should be stable and easy to manage. Where possible special dining room and work tables should have legs so separated as to make the wheel chair fit under them. There should also be platforms at wheel chair height to which the patient may transfer so that he may develop the confidence of independence which results from his ability to transfer from the chair to another surface.

The paraplegic patient can get about on a wheel chair but this is not suited to the ordinary demands of life. The paraplegic must be put on crutches as

tant anesthesia, will permit bony prominences in dependent and pressure areas to produce ischemia without painful warning, and decubitus lesions will develop rapidly. The position of the patient must be changed at frequent and regular intervals. The skin overlying pressure areas should be protected with pads, pillows, or rings. Diminished intestinal tone and peristalsis result in obstipation. Impaction and incontinence may persist for some time. Enemas must be given regularly. Bowel habit training should be instituted early. Another usual complication is atonicity of the urinary bladder with involuntary periodic urination, which in complete transverse lesions is permanent. The dynamics of the bladder and suprapubic hygiene and drainage will vary with the individual and will require the close attention of the urologist, nurse, and patient.

The physical therapy technician will be required to treat the patient daily. In the early stages when the patient is restricted to bed, daily heat, massage, and passive motion will help maintain vascularity, tissue turgor, and joint mobility. A major problem is muscle spasm, which if unchecked may lead to flexion contractures, and this must be avoided in the knee joints particularly. The use of the Hubbard tank is recommended by some, but against its possible advantages must be weighed the apprehension of the patient when he is raised on the overhead pulleys, and the contamination of the water by incontinence. Localized wet heat packs have most of the advantages of underwater therapy and none of its disadvantages. Gentle passive motion applied frequently, as well as the application of braces, will prevent further contractures.

*Late Treatment.* As soon as the attending physician feels that the institution of exercise will no longer be detrimental to the patient, a schedule of progressively increasing physical activities should be begun. Such exercise must have as its objectives the development and maintenance of a high level of physical fitness, strengthening of incompletely denervated muscles, but most important, the overdevelopment of those muscles of the upper extremities and shoulder girdles which the patient will one day require for crutch walking.

Physical fitness is increased by calisthenics. This is uninteresting and the exercise instructor must use his ingenuity and persuasion in getting the patient to perform tedious and undesired work. Calisthenics should be varied and wherever possible some form of apparatus or sports equipment should be added, as well as the use of music and any other attraction which will get the patient to cooperate.

The strengthening of weakened muscles is a matter of muscle re-education,

ordination to master it. Such patients must be taught other methods of crutch walking.

In the four point gait the sequence of motions is (1) left crutch, (2) right leg, (3) right crutch, (4) left leg. This gait is slow but good in crowds or where space is limited. When this gait is mastered it can be speeded by a variation in which the first step is simultaneous motion of the left crutch and right leg followed by the right crutch and left leg.

*Gymnasium* The gymnasium for paraplegics should be equipped with mats, parallel bars, ramps, steps, and other equipment designed to permit maximal variation of exercises for strengthening the muscles involved in crutch walking. Patients should be scheduled for daily progressive exercises in the gymnasium as soon as they can be placed in a wheel chair. Exercises with frequent rest intervals should increase in duration daily until the patient attends two hours each morning and afternoon. In the gymnasium the patient is also given practice in crutch walking, getting out of the wheel chair, and overcoming the physical demands of daily routine he is likely to encounter. Models of street curbs, bus steps, and other common obstacles the patient may encounter should also be placed in the gymnasium. Instruction must be given in sidestepping, walking backward, and ascending steps.

Walkers and parallel bars are good when walking is first begun but this should be discontinued as soon as the novelty wears off so that the patient will not come to rely upon it. It must be remembered that the average patient will return to a home where at most only a few helpful gadgets will be available to him and the aim should be the use of common items used in daily living.

The paraplegic must be encouraged to manage his personal hygiene. As soon as he can get into a wheel chair he should shave in the washroom, shower in an enlarged shower room, and be encouraged to defecate in an ordinary bowl. If his strength is not great enough to swing onto the regular bowl even with the aid of a fixed overhead bar, he should be placed in a portable chair fitted with a toilet type seat, which can be wheeled over a standard bowl.

A record of progress should be maintained for the information of the professional staff and the morale of the patient. The patient should be encouraged to maintain his own progress record.

#### AMPUTATIONS

The loss of part of or all of an upper extremity does not pose a very serious rehabilitation problem if the remaining upper extremity is good, but bilateral

early as possible. Not all patients will be able to use crutches and it is most important to measure muscle potentiality before permitting a patient to build his future plans on false beliefs.

In order to walk on crutches the patient must have normal neck muscles and sufficient strength in his fingers to grasp the crosspieces of the crutches. He must develop enough power in the anterior deltoids or pectorals to swing the crutches forward. To get on to his crutches from the sitting position he must have potential strength of the extensors of the elbow (triceps brachii), the adductors of the humerus (pectoralis major and latissimus dorsi), the downward rotators of the scapulae (the rhomboids and pectoralis minor), and the depressors of the shoulder (pectoralis minor and trapezius). These muscles must be tested for activity and for nerve function if indicated. Each of these muscles must be exercised to the limit daily. The patient must be convinced that his happiness depends upon their overdevelopment.

*Rising from Chair.* The patient must be taught to rise from his chair. He must master this maneuver as well as the return operation to permit independent action. He should be instructed to sit forward on the chair and cross one leg over the other with his hand. He then turns toward the side of the under leg, supports himself behind on the seat of the chair, rotates completely with his hands and climbs up the back of the chair until his feet strike the floor. Then he pushes his hips back, straightens his trunk and while holding onto the chair with one hand places a crutch under one and then the other axilla.

*Crutch Walking.* Any object can be supported on three legs if a plumb-line dropped from its center of gravity falls within the triangle formed by the three points of support. Maximum security is approached as the center of gravity approaches the center of the triangle and as the triangle increases in size and becomes equilateral.

The crutches form two legs of the tripod and the flail extremities encased in braces form the third leg. The patient is "hung" on the top of his crutches and is shown how to balance on them at rest. At least one adequately braced leg and extended hip, locked if necessary, is required. Walking is accomplished by thrusting the head forward with the neck muscles until the change in the center of gravity upsets the body balance forward and the feet are dragged along the floor up to the crutch tips. At this point the head is thrown backward, the body raised slightly on the crutch crosspieces enabling the feet to be swung forward. This method of crutch walking called the "swing through" is the most desired because it permits rapid locomotion. Unfortunately there are many patients who will not have the muscular power or co-

An Ace bandage is applied under the maximum tension which the patient can tolerate without embarrassment of circulation. In order to taper the distal end the maximum pressure is applied there. Much effort must be expended in this procedure and a minimum of four daily reapplications over a period of three weeks is recommended by Kessler.

The old pommelling methods of massage as well as other forms of massage are not indicated for the stump. Exercises are important especially in above-the-knee amputations, particularly for the short stump, because the insertion of the adductors is removed and this permits the unopposed adductors to create an abnormal position of the thigh which will later interfere with walking.

Above the knee amputees must relearn balance, because normally the foot muscles control balance and now the hip muscles must be taught this function.

As soon as the postoperative condition permits, exercises should be commenced in bed, not only on the stump but on the trunk for the prevention of postural defects, particularly the lordosis seen in lower extremity amputees.

As soon as the patient is ambulatory, systematic stump exercises should be begun in the remedial gymnasium. A canvas sling attached to wall pulleys is placed around the stump and the patient is instructed to face in different directions for each exercise period so that the entire range of motions of the joint is accomplished. The exercises should be progressive each day so that the number of excursions and the amount of weight lifted increases to tolerance.

#### AMBULATION

As soon as the prosthesis is fitted the patient is taught to balance on it with the aid of crutches. In thigh amputations the extremity must be adducted in making a forward step. The first step should be short and taken with the good leg and this should be followed by placing the artificial leg just in front of the good one. In guiding the steps of the patient it is important to prevent hesitation on the sound leg. He must be taught to spend the same amount of time on each. Parallel bars with a mirror facing the amputee offer an excellent method of learning. Bilateral amputees proceed with four motions: left hand, right foot, right hand, left foot. Unilateral amputees advance both hands with the prosthesis and then move the sound extremity forward. When patients advance from parallel bars to crutches the same cycle of motions is employed. When crutches have been mastered the patient is given two canes and as soon as possible after that he progresses to walking without

loss of upper extremities requires considerable attention. Too few amputees wear the appliances after they have received them, yet the psychological effect upon employers and companions should warrant the filling of empty sleeves. The choice of appliances will depend upon the expected use. If it is required for esthetic reasons alone, a simple light arm is desirable. For the patient who is anxious or willing to learn the operation of a serviceable appliance (and this should be urged for all), the prosthesis should fulfill three needs—ability to grasp, raise, and pull. Where the stump permits, the kineplastic arm of Arano (developed in this country by Kessler) should appeal to all intelligent patients. In the kineplastic arm, the muscles which remain in the stump are canalized to admit pegs which are attached to levers in an artificial hand mechanism, by means of which patients with bilateral amputations of the upper extremities have been enabled to play the violin.

The double arm amputee is best trained by a patient who has overcome this handicap and the early use of motion picture films such as *Meet McGonagal*, which demonstrates to the newly disabled the possibilities available to double arm amputees, will offer the patient solace and stimulate his desire to live and learn to use appliances.

A patient with an amputation of one lower extremity will usually be able to readjust without much difficulty although in certain instances he will not be able to perform standing work. In double leg amputations, if one stump is below the knee, locomotion can be accomplished without too much difficulty, but if both stumps are above the knee the mass of ordinary appliances will be too great and short appliances should be used.

#### PHYSICAL THERAPY

The chief consideration following amputation is the prevention of contracture of the nearest joint. Prosthetic appliances, particularly of the lower extremities, can only give maximum service if the joints above it are freely movable in all directions. It is not uncommon for the nurse or attendant to place a pillow beneath the stump when the patient returns from the operating room. This must be discouraged and the patient must be encouraged to keep the nearest joint moving as soon as the sutures have been removed. The first step is active motion.

Following amputation the two major objectives are preparation of the stump for an appliance and instruction in the proper use of it.

For maximum comfort and fit the stump must fit the prosthesis in telescopic sleeve fashion. To this end the stump must be shrunk and shaped from a bulky cylinder to a tapering cone. Shaping is accomplished by bandaging.



given exercises of the facial and other muscles involved in speech. Some patients are taught lip reading because their visual perception may be less involved than their auditory.

Because there is a certain rhythm to normal speech the patient who shows especial hesitation or loss of rhythm is given training in rhythm which can be utilized, as foot tapping or rhythmic motions in time to music. Such drills are combined with actual speech rhythms.

Although Shakespearean characters are frequently heard talking to themselves, speech is primarily a group activity and speech rehabilitation must be developed with group classes in which emphasis must be placed on the simple common words of daily routines. Among the first words a child learns are the names of foods, functions, and faces. A similar procedure is adopted with the aphasic. He is taught all language abilities together. He sees the apple, the word apple, the picture of an apple, and at the same time he tastes an apple and is instructed to use the word apple in a simple sentence. These exercises must be repeated on the same and succeeding days.

The training of aphasics is a very tedious process. It is not always successful because there is no method at present of determining probable prognosis, but it is a process which is certainly worth instituting because of the great number of patients who can make some progress and the great progress that can be made by some. Only accredited speech therapists should be permitted to handle such patients and institutionalization is most desirable for proper handling.

### VISUAL IMPAIRMENT

#### LOSS OF VISION IN ONE EYE

The patient who has lost one eye or its function presents three major problems: the psychological trauma, the loss of three dimensional vision and the need for an artificial eye. The loss of binocular vision requires re-education of the sense of equilibrium by means of balancing exercises, jumping, and the use of parallel bars. The more static exercises and calisthenics are followed by sports and games in increasing tempo and duration which rely on visual acuity in gradually increasing amounts. Indoor games can begin with slow moving checkers and advance through pool or billiards and finally end with fast moving ping pong. A similar schedule for outdoor games can be developed. The patient should also be given occupational therapy and reading parallel to the sports program. Occupational therapy can begin with coarse weaving on a large floor loom and progress through smaller looms.

support. If a single cane is used for a protracted period the patient may lean too heavily on the side of the good leg with possible resultant scoliosis.

#### ROUTINE PHYSICAL DEMANDS

While in the hospital the patient should be instructed in the management of the obstacles he will meet in daily excursions, such as mounting curbs, and steps, turns, and ramps. He must also be given instruction in getting in and out of chairs, picking up objects from the floor, and walking backwards and sideways.

#### APHASIA

Aphasia may result from any involvement of the speech areas of the brain. If the pathology is reversible as it may be in inflammation, or if the disability is caused by pressure which can be relieved surgically, some restoration of the nervous function is likely. It is unusual for the entire speech area to be destroyed, and even if it is, there is always the area on the other side which may become activated by training. In every case speech rehabilitation is worth trying, and trying early. Long delays may result in either discouragement or the adoption of an invalid pattern of life which the patient and family accept.

Aphasia may manifest itself in loss of understanding (perspective) or loss of the ability of self expression (expressive). The return of these functions depends, in most cases, upon prolonged tedious speech re-education by trained personnel called speech therapists whose chief attribute is patience.

Because of the association between speech and handedness, an attempt is made to exercise the extremities *on the side* of the brain lesion. Such exercise may take the form of occupational therapy, sports, eating, writing, etc. This shift is often natural since in many cases there is paralysis on the side opposite the lesion. There is no proof that such activity is of direct aid in re-establishing speech pathways in the brain but the practice seems advisable.

A great difficulty for beginners is to control their desire to speak rapidly at the beginning. There is usually a tendency to try hard and this frequently results in greater confusion with resultant anger, hopelessness, and resignation. The patient must be taught to relax and remain silent until the instructor gives the signal for repetition of a single word or phrase. Relaxation of the entire body as well as thought is taught. Some aphasics have also lost coordination and proper use of the voluntary muscles. Such patients are taught the use of simple motions by imitation of the instructor who sits opposite the patient and performs them until the patient learns to repeat them. He is also

impressions such as dominos, chess, etc. Participation in amusements such as dances, and sports such as swimming and horseback riding should be encouraged when available.

Typewriting should be substituted for longhand writing since proficiency does not require observation of the keys. Braille presents considerable difficulty for some and much persuasion will be required to prevent abandonment by the slow to-learn.

Vocational counselling should begin as soon as possible. It will be of considerable psychological benefit for the patient to hear about the possibilities of future employment and the hospital should be equipped with testing materials and vocational exploratory equipment both hand and motor operated.

The mental attitude may be colored by the sudden darkness and uncertainty. This will sometimes be reflected in loss of appetite, bolting of food, gastric dysfunction, and constipation. Sighted persons should be placed at the dining tables to prolong meals and make them more interesting with cheerful conversation. *The use of mealtime music is also recommended.*

The use of dark glasses is sometimes desired by patients for cosmetic reasons. This should be discouraged. Some patients never lose hope that vision will return in the presence of an obviously irreversible pathology. They will refuse enucleation of shrunken eyes for replacement by cosmetically superior artificial ones. Each patient must be treated as an individual and personal psychological and vocational guidance is necessary.

#### AURAL DISABILITY

Progressive or permanent loss of hearing when present in both ears requires aural rehabilitation when the loss as determined by the audiometer exceeds an average of more than thirty decibels for the conversational range of tones in the better ear.

If rehabilitation is intensive it can usually be accomplished in two months or less. The schedule of treatment includes fitting and use of hearing aids, instruction in lip reading and speech training in addition to the common denominators of rehabilitation.

#### HEARING AIDS

The sound characteristics of several different commercial hearing aids are correlated to the audiometer evaluation of the patient. The patient tries out a few of the most suitable aids, and is then ready to learn the use of the most satisfactory one.

While in the hospital or at home he turns the hearing aid on at full

until cord-knotting is accomplished. The patient should not be discharged from the hospital until an artificial eye, pleasing to the patient in appearance and comfort, has been fitted.

#### BLINDNESS

Even more important than with most other disabilities, those recently deprived of sight must be handled in a group as the only economical means of maintaining the skilled personnel required in psychological and educational management. There must be an early indoctrination in personal hygiene and care. The amount of effort expended by the patient in this will be an index of his attitude towards his disability and his probable success in meeting his handicap. He must be taught how to put away his toilet articles and clothes so that he can find them easily again. He should be taught to feed himself at first from a soup plate with a spoon and later with a fork and knife from the usual plate on which the food is served cut up. He must learn his way around the hospital and its grounds by means of landmarks on walls or islands in the walks. Movable obstacles must be kept orderly and in the same place, and doors must not be kept ajar. Attendant personnel must learn to announce their identity by speaking first so that the sightless patient will be put at his ease by recognition. While walking by the side of the patient hospital personnel should offer their arms for guidance and not grasp the arm of the patient.

All these new facts and methods are difficult to grasp rapidly and the mind of the patient becomes fatigued. This, together with some degree of the mental depression which accompanies blindness makes the learning process even more difficult. Sooner or later the beneficial stimulus of new environment and people will wear off and many patients will experience a delayed or late mental setback characterized by such symptoms as irritability and anxiety. For such symptoms Lady Duke Elder recommends a change of scene to home and friends. If the family and friends are properly oriented and welcome the patient home in a manner closely resembling their former treatment of him he will probably return to the hospital in a more receptive mood for further rehabilitation.

With the passage of time the patient will gain confidence in his newly acquired abilities. He should be given instruction, and diversion in crafts, shop work, and music. Maximum use should be made of ordinary equipment and only in types of instruments such as are used in precision measurement should especially raised markings be employed.

The patient should be encouraged to play games which transmit tactile

## GRADUATED EXERCISE

The right moment at which to begin exercise following a prolonged period of bed rest is controversial. Some clinicians feel that even slight occasional rises in temperature contraindicate exercise and others are willing to permit a trial period. Since it is our aim here only to describe rehabilitative procedures and not to enter into a discussion of pathophysiology, it is left to the individual physician to decide the optimum time for mobilization. For many people the simplest and most pleasant form of regimented exercise is walking, and this form of exertion can be as interesting as the countryside and the companionship of other patients. A hospital employee should be delegated to conduct walks which can begin at two or more different periods of the day for groups with varying prescriptions. A record should be kept of the pulse at the beginning and end of each walk to determine the safety of increasing the distance traveled. The distance would be increased slowly and gradually over a period of three months until a one mile round trip is traversed, and this should be continued until the time of discharge. Exercises for the tuberculous are described more completely in Chapter XXIII.

## THORACIC SURGERY

The increased safety and performance of thoracoplasty in tuberculosis hospitals has resulted in the increased need for correction of the postural deformities which follow removal of part of the thoracic cage. There is a tendency for the head of the patient to tilt toward the side of the operation and unless this is properly managed a permanent deformity will result. Prior to operation the patient should be taught the stretching exercises which he will have to perform during his postoperative convalescence to avoid increased spinal curvature. Some curvature is to be expected with the best care.

As soon as the postoperative condition permits, pillows should be so adjusted in the bed as to counteract the tilt of the head, and a mirror placed at the foot of the bed will help the patient to appreciate and correct his alignment. When he becomes ambulatory a rigid regime of exercises must be enforced to prevent a postural change which can progress to a gross deformity.

## EDUCATION

Unlike almost all other groups of chronically hospitalized patients, those suffering from arrestable tuberculosis are restricted to a bed or ward for many months while they are in possession of all their faculties and are almost free of all symptoms. Their "incarceration" hangs upon a sputum or x ray report

volume for as long as possible each day to become accustomed to living with amplified ordinary noises of clothing and the environment. When fatigue sets in he is instructed to turn off the current with the earpiece in place until the ear is rested and then repeat the performance. When the earpiece becomes uncomfortable it is removed until the discomfort wears off. The first contact with conversation should be with a single speaker at a distance of about six feet. The patient then moves to about fifteen feet from the speaker and adjusts the volume control to speech at that distance. The patient should not use the hearing aid outside until indoor hearing has been mastered, and when he ventures out of doors the volume must be diminished to avoid the shock of urban noises. The hearing aid should not be turned on and off for selective listening because such action will make reception difficult. For radio listening the volume of the radio receiver should be set so that normal listening is proper at about six feet from the loud speaker.

#### LIP READING

Instruction in lip reading will require about an hour each day, individually, for about two months and a similar period of group instruction. Instruction is a tedious process which begins with the recognition of simple lip movements progressing to more complicated movements and finally the recognition of common expressions and sentences.

The relatives and intimates of lip readers must be oriented to make interpretation easier. The lip reader must see the lips in good light. This usually means the light should be behind the reader. The speaker must offer as little distraction as possible through gestures, gum chewing, and purposeless movements of the face or lips. Speakers should not exaggerate their voices or word formation. The reader can understand polysyllables more easily than monosyllables and phrases and sentences should be spread out to increase the opportunity of comprehension.

#### TUBERCULOSIS

The survival rate of tuberculous patients admitted to a hospital will depend upon the duration and severity of the disease, but during recent years the earlier recognition of the disease, the introduction of more intensive treatment and the number of victims who can once more become productive makes rehabilitation an integral part of their treatment. The incidence of relapse is in part at least dependent upon the physical activities in which the quiescent or even the sputum positive patient engages after discharge from the hospital.

tive physical exercise, and Medical Rehabilitation, which includes educational retraining and shop retraining, a form of pre vocational exploration. All five of these divisions are integrated with each other and where possible with psychometry and vocational guidance and rehabilitation.

Such a program is only applicable to hospitals where patients remain sufficiently long to benefit and where the endowment or subsidy is great. It is a very expensive program, but, in the long run, those patients who take advantage of the opportunities offered will present a minimal problem to the community to which they return, considering the time saved in becoming gainfully employed, the number who would not otherwise return to gainful employment, and the effect on readmission (especially among psychiatric patients) this program becomes sound economically.

#### EDUCATIONAL RETRAINING

Experienced high school or college instructors devote their entire day to patients. With the cooperation of social service workers and vocational advisers they help enroll suitable patients in correspondence courses of live classes in such practical subjects as small business administration, stenography, poultry raising, and almost any other elementary or advanced subject. By arrangement with accredited educational agencies, patients can receive scholastic recognition for the work that they complete at the hospital, and some have received high school diplomas as a result of completing a few needed subjects.

#### SHOP RETRAINING

Qualified instructors in mechanical and other skills guide the patients in the performance of machine tool operation as well as other vocational pursuits in conjunction with academic studies when possible. The hospitals of the Veterans Administration not only have complete sets of power tools for woodworking, shoe repair, and garment manufacture but some of them have working farms, piggeries, and poultry raising facilities. All forms of retraining are initiated with the approval of the physician in charge of the patient and the patient flow through such activities is guided by occupational therapy aides or other qualified personnel.

#### INDUSTRIAL THERAPY

The therapeutic use of patients in psychiatric hospital maintenance was called Industrial Therapy by Bryan. Patients with previous skills are used as assistants to utility craftsmen, or help in the laundry, landscaping and grounds

and regardless of the intellectual level of the patient prolonged unproductive living can become difficult. Since physical exertion is usually not allowed during most of this period, bedside occupational therapy is limited to the light crafts which are becoming increasingly acceptable to male patients but is still resisted by some. More important than diversional craft work for those who will accept it is preparation for return to the community as a wage earner. With few exceptions the tuberculous patient will require a sedentary job in which the major exertion should be mental. This limits the field largely to commercial work and handicrafts.

The average stay of the salvageable patient is from one to two years and at least one of these years can be devoted to education in bed. It will become necessary for the hospital to employ instructors and many institutions already have these, although hospitals operating on a smaller budget have used occupational therapists or other staff members to perform this work. The instructor must confer with the physicians to determine the probable duration of hospitalization and prognosis in relation to future disability and employability. He must then confer with the vocational guidance counsellor or in the absence of such learn the rudiments of testing and guidance himself. The major problem in most instances is convincing the patient of the value of education during hospitalization and the maintenance of aroused interest. Education must be correlated to future work and all agents and agencies should be invited to participate. Excellent correspondence courses are now available from recognized State Departments of Education, university extensions, and correspondence schools.

#### RECONDITIONING AND REHABILITATION

During the second World War the armed services of this country early adopted an elaborate program for convalescent patients which went by different names in the different services. The British introduced the word Reconditioning, implying an active approach to the deconditioning of the physical effects of hospitalization. The Army Service Forces accepted this word to describe its program, the Air Forces preferred the term Convalescent Program, and the Navy adhered to the older and more widely used term Rehabilitation. Following the first World War the Veterans Administration favored the word Reconstruction to encompass a program of physical therapy and occupational therapy. At present the Veterans Administration is employing the term Medical Rehabilitation to include all the branches developed during the second World War in Service Hospitals. These are Physical Medicine, which includes physical therapy, occupational therapy, and correc-



but is rarely found in practice because of the great number of skilled workers needed to guide such a program

Sheltered workshops have been successfully employed for the blind and the orthopedically handicapped but its most dramatic success has been with tuberculous patients as exemplified by the Altro Work Shops, in New York City. Because of the high percentage of garment workers discharged from the tuberculosis service of the parent hospital the Altro Work Shops established garment manufacture as their craft. The post-medical treatment of selected patients has become a period of "industrial convalescence," where the patient is gradually hardened by progressively increasing work over a sufficiently prolonged period so that he can graduate to a work a day world. By this method, the mortality rate over a ten year period of the tuberculous discharged from the Work Shop has been dramatically less than similar groups followed at other clinics.

The physician owes his disabled patient more than medical or surgical care. He should familiarize himself with the rehabilitation facilities of his community and guide his patients to them. The barrier at the end of the road to recovery must be opened to the avenues of rehabilitation.

#### REFERENCES

- BACKUS, O L., et al. Aphasia in Adults. Ann Arbor, University of Michigan, 1944
- Baruch Committee on Physical Medicine. Annual Reports from 1943. *J Health & Phys Educ*
- DUKE ELDER, P M., and DAVENPORT, R C. Rehabilitation in ophthalmic cases. *Brit J Phys Med*, 5, 88, 1942
- British Committee on Rehabilitation. Report on Rehabilitation. *Brit M J Supplement* June 29, 1946
- KESSLER, H H. The Crippled and the Disabled. New York, Columbia University, 1935
- SILTZBACH, L E. Rehabilitation of tuberculous. *Am Rev Tuberc*, 44, 357, 1941
- United States Bureau of Medical Surgery. Handbook for the Newly Blinded. U S Government Printing Office, 1946
- Convalescent care of patients with spinal cord injuries. *War Med*, 8, 199, 1945
- United States War Manpower Commission. Selective Placement for the Handicapped. U S Government Printing Office, 1945
- Volta Review (a periodical devoted to the problems of the hard of hearing). Volta Bureau, Washington, D C

maintenance, or perform clerical work. During the recent war industrial therapy was extended to its physical use as a form of functional occupational therapy.

The execution of such work requires close liaison between administrative and maintenance department heads and the occupational therapy department. One occupational therapist should be assigned to industrial therapy and she should analyze all the positions which can be filled by patients for psychiatric and functional improvement of the patient. The physician who prescribes industrial therapy must list precautions and medical objectives. The industrial therapist must interview patients before placement to ascertain suitability and willingness because even though assignment is on prescription basis a resistant patient may influence other patients adversely.

Industrial therapy can also be used as a sheltered workshop to revive or sustain interest in work or to determine physical endurance and readaptability to work in a specific occupation.

#### SHELTERED WORKSHOP

There are many disabled who will never be able to be gainfully employed in a normally operating industry or business. There are others who will only qualify for such work after months or years. Many of these people do not wish or are not eligible for institutional care. Many of them will find happiness only if they are allowed to satisfy their work appetite or their pride in self support. For such people there has been developed the *sheltered workshop*. A sheltered workshop affords an opportunity for the disabled to work when they can at what they can. In some shops machinery can be adapted to the disability; in others the usual equipment is used and the patient completes his task in a longer period. Work can be graded according to physical or mental effort, the progress of the disease, or the nature of the disability.

If the disabled worker seeks ordinary employment, a sympathetic or related employer may give the applicant *light work*. Fellow workers are usually unsympathetic toward the light worker. It would be necessary to explain the nature of the disability to all. This is exactly what the disabled does not want. In a sheltered workshop anyone may do light work without exciting the criticism of neighbors.

Not only does such work lessen the possibility of decline in morale, but in selected patients the work can be correlated to the disability and used to strengthen or coordinate muscle groups or to improve endurance. Such therapeutic application of gainful occupation to disability makes good reading

	<i>Number of Hours</i>	
	<i>Theory</i>	<i>Lab and Practice</i>
Anatomy (including applied anatomy, demonstration on cadaver and lectures)	210	
Clinical practice		400
Electrotherapy	30	45
Ethics and administration	5	
Hydrotherapy	5	15
Massage	15	45
Pathology	30	
Physiology	30	45
Principles of physical therapy as applied to		
Medicine	15	30
Neurology	10	15
Orthopedics	15	30
Surgery (including surgical observation)	15	30
Psychology	15	
Therapeutic exercise	30	75
Electives	45	
	470	730
TOTAL		1200 hours

Suggested elective courses are *asepsis, bandaging, first aid, history of physical therapy hygiene, joint measurement, office routine, occupational therapy, records, social service*

practice the physician will find it advisable to conduct treatments himself. His technician may act as assistant, and she can also observe the patient during the treatment. The rationale for administration of a given treatment may be very complex, requiring knowledge of the patient's pathological status as well as knowledge of the physiological changes induced by the treatment and also the technique of its application. These factors can be properly evaluated only by a physician. The mechanical factors involved in the actual application of many types of treatment are relatively important. A good technician may apply the treatment as deftly as the doctor. However, psychologically, this procedure is bad. The patient, as a rule, feels much better if the doctor applies the electrodes, the radiation, and so forth. If he does not do so, he should at least be present while the technician makes the application so that the patient has the assurance that the treatment is administered correctly.

## CHAPTER XV

# THE CONDUCT OF TREATMENTS

### GENERAL CONSIDERATIONS

**T**HE PHYSICIAN ASSUMES LEGAL RESPONSIBILITY WHEN he treats patients by physical agents just as he does when he employs chemical agents. He must therefore exercise reasonable professional care in the treatment of his patient. This includes taking a history and making a physical examination. When an unusual form of treatment is used, the physician assumes an additional risk because, if any accident occurs, the plaintiff may contend that this ministrations differs from accepted practice.

The physician is also liable for any damage done by his representative—technician or nurse. Therefore he should be certain that his technician is skillful and well trained. Members of the American Registry of Physical Therapy Technicians\* are graduates of schools approved by the Council on Medical Education of the American Medical Association. Most of these schools are affiliated with well-known universities. The Council requires that the course should be of nine months' duration, and should include the subjects listed on page 431.

Prerequisite training required for entrance to these schools stipulates (1) graduation from a school of physical education, or (2) graduation from a nurses' training school, or (3) two years of college including a minimum of sixty hours with courses in physics and biology.

The physician who employs physical therapy relatively infrequently may find it adequate to train his own nurse or office assistant in the techniques which he employs. He should, of course, make absolutely certain of the correctness of her knowledge before he entrusts the treatment of any patient to her.

Specific instructions should always be given to a technician, either in the office or the hospital. The type of application or applications, the doses and their duration should be definitely stated, or better, put in writing. In private

\* Information concerning the Registry and its members can be secured by writing to the Registrar, American Registry for Physical Therapy Technicians, 30 North Michigan Avenue, Chicago, Illinois.

normal sensory changes in the treated area. An example is the anesthetized patient who is subjected to surgical diathermy. Cold has an anesthetic effect. Thermal sensitivity may be lost because of neuropathological changes

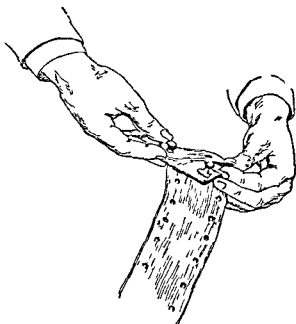

FIG. 244 Perforated rubber bandage used to encircle part and hold electrodes in place. Small plastic knobs offer a convenient means for anchoring the bandage.

such as a sectioned nerve, syringomyelia, and the like. Thermal sensations may be either completely lost or considerably diminished as a result of pressure, for instance, when electrodes are placed between a hard surface and some bony region of the body. Injection of a local anesthetic may render the part insensitive to heat for a considerable period of time. Where a small quantity of adrenalin is mixed with the local anesthetic, relatively mild thermal energy may cause damage, because the interference with circulation lessens the ability of the region to lose heat. Organic changes, such as arteriosclerosis, thrombo anguitis obliterans, varicosities, interference with lymphatic drainage, may also diminish the capacity of a part to react as it normally should so that heat applied is not carried away with normal speed. Collections of fluid, such as pus, serum, and extravasated blood, affect normal thermal tolerances. In these areas, the circulation exists only at the periphery and not in the center of the mass. This peripheral circulation may be diminished because of the pressure of the fluid which may, in effect, act as a foreign body and thus create a relative ischemia. Ischemic areas may also exist where there is compression, particularly against bony parts, and where

Departments of physical therapy in a hospital should always be placed in charge of a physician. This arrangement results in a greater respect toward the department on the part of other physicians who may refer patients; it has a good psychological effect on patients; the technician benefits from the knowledge and advice of one familiar with the medical aspects of disease. Hibben says that when a physical therapy department is in charge of a physician trained in physical medicine, and when his assistants are registered physical therapy technicians, the medicolegal liability of the hospital is diminished about 90 per cent.

The patient's surroundings are important. An office should be clean, and facilities should be provided for the patient to undress in privacy. Each patient should be given a fresh sheet. A quiet office makes the treatment more pleasant. Patients, even those who are "never able to sleep during the day," will frequently relax and go to sleep during treatment. A noisy office has an irritating effect on the patient.

In a busy clinic, however, it is inadvisable to permit a patient to fall asleep during a treatment, particularly when convulsive heat is being used. Because physical therapy treatments require rather long periods of time, it is usually necessary for the physician to treat several patients at once. When, as frequently happens, treatments are administered in one large room which is divided into cubicles, conversations can be readily overheard. Any discussion of a private nature should, therefore, be held in a consultation room or in some other quarters where the conversation will not be overheard. Sheets and other linen used for the patient should be clean. It is more economical to use paper towels and paper sheets, but these are less comfortable and do not give the same impression of neatness as do cloth towels and sheets.

#### OCCURRENCE AND PREVENTION OF ACCIDENTS

Because of the ever-present danger of causing injury to the patient, his complaints should be given prompt attention. Many patients are of a stoical nature and will tolerate the sensations accompanying a burn. Therefore, at the beginning of treatments, patients should be instructed to mention any feeling of discomfort. In addition, it is well to inquire specifically of the patient during the course of his treatment whether he is feeling comfortable. Many patients are also under the impression that a remedy is not of value unless it causes discomfort and that the toleration of such discomfort is necessary for effective treatment.

Caution is particularly essential when a patient is unable to appreciate his own thermal sensations either because he is unconscious or because of ab-

is actual administration of a treatment. The initial dose should be very small in order to gain the patient's confidence. When this has been accomplished, the intensity and duration of the applications can be increased grad-

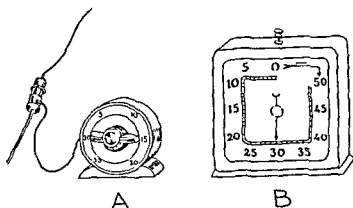

FIG. 246 A Automatic electric timer B Timer with bell ringing device

ually. As soon as a treatment has been discontinued the treated area should be inspected to make certain that no damage has been done, and the patient should be instructed to communicate with the doctor if there is any subsequent change in the appearance of this area.

Accidents occasionally occur while patients are getting on or off treatment tables. Where the treatment table is high, it is necessary to use a small stool. If the patient does not plant his foot solidly in the center of the stool it may tip and cause him to fall. Care must be exercised in transferring patients from wheel chairs to treatment tables and back again, and also to and from stretchers.

#### APPARATUS

Every physician wishes to be certain that the apparatus which he employs is dependable, efficient, and relatively fool proof. The Council on Physical Therapy of the American Medical Association investigates physical therapy apparatus placed on the market, and requires that its standards be met before it approves any apparatus. The specifications that must be met by manufacturers of apparatus who desire to sell their equipment to the Department of Hospitals of the City of New York will be found in the Appendix. Therapeutic devices should be kept in good working order, they should be inspected at regular intervals to make certain that binding posts are tight, that wires are not broken, and that all parts are in good repair.

The question arises as to whether electrical apparatus should be used during thunder storms. If power lines are strung overhead, a surge may be

there is mechanical interference with venous or arterial circulation due to the presence of constricting bands or tight bandages. If the electrodes are held in place too snugly, particularly by a non-yielding bandage, there is

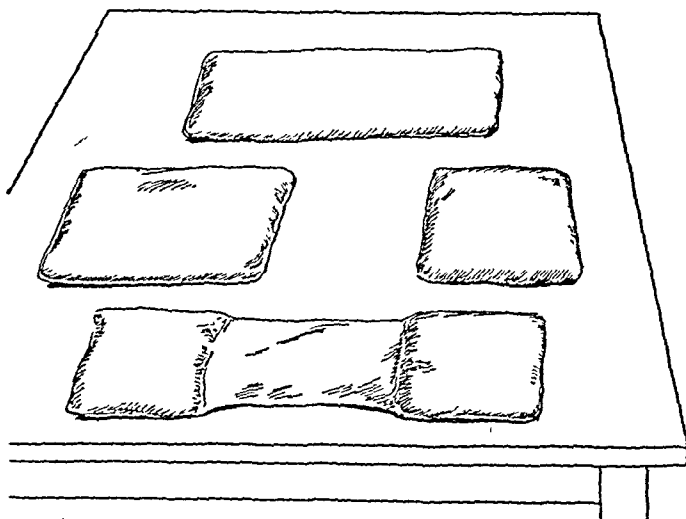

FIG. 245. Sandbags. Useful to hold electrodes in place.

danger of causing injury and discomfort. When a technician administers the treatment, as in a hospital or clinic, she should be informed of any abnormalities from which the patient suffers which necessitate extra caution. The words "diabetic," "cardiac," "hypertensive," and so forth, prominently written on the prescription slip will serve to warn her (Figs. 244, 245).

The duration of a treatment should be predetermined. Timing devices help to make certain that it is terminated at the end of the specified interval. In a busy clinic it is convenient to use a device which automatically discontinues the current and causes a light to come on or a bell to ring. Where smaller numbers of patients are treated at the same time, as in the physician's office, the time at which the treatment is begun, or better still, the time at which it is to be terminated may be noted on a paper pad. A clock should be placed where it is readily visible (Fig. 246).

The physician or technician should be within immediate call of the patient so that the treatment may be discontinued quickly if necessary. An apprehensive patient will be reassured if he is given a device which will permit him to turn the machine on and off at will. Before administering treatment which is new to the patient, the physician should reassure him and also describe the sensations which will be felt. Some patients have a fear of electricity; former experiences may have conditioned them against all forms of electrical contact. For these patients, the most definite form of reassurance



over-exposure caused by the subject falling asleep during a self-administered treatment. Not only laymen may suffer in this fashion, the physician who exposes himself to his own ultraviolet apparatus should depend on another person, or some mechanical device, to terminate the treatment at the proper time. While the danger that a quartz burner will break is remote, the possibility makes it advisable that the burner be placed to one side rather than directly over the patient. Carbon arc lamps should be screened or placed so that there will be no contact with burning sparks. Fisher calls attention to injuries caused by the glare that occurs when a flash is produced on contact between metal and electric current. The radiation developed by this arcing is rich in ultraviolet, visible, and infra red components. The heat of the ultraviolet rays may produce a reddening of the skin. The brilliant light causes blanching of the visual purple in the retina and temporary dimness or fogging of the vision. Usually these symptoms disappear and vision is completely restored within forty-eight hours.

*Thermal Measures* Local tissue is damaged when its temperature is raised beyond the point of tissue viability. Thermal tolerance differs in various parts of the body. In general, elevation of temperature of the tissues above  $110^{\circ}$  F causes injury. The permissible temperature of the substance placed in contact with the skin surface varies with the ability of the substance to absorb and to give off heat. The temperature of the water in a hot water bag is high enough to cause a burn if it comes in direct contact with the skin. The hot water bag should be carefully inspected to make certain that it has no leaks, it should also be covered with a towel before it is used, as the surface is frequently too hot. The same precautions should be observed with the Elliot apparatus, which is essentially a rubber bag in which hot water circulates under pressure. The wires in electrically heated pads and blankets may break, with a resultant short circuit and danger of burns. This danger also exists if the pads become wet. Hot, melted paraffin may produce an unfavorable reaction in sensitive skins, even after the paraffin has been permitted to cool to the point where a film is produced on the surface. Normal skin can be damaged if it is brought in contact with melted paraffin at a temperature higher than  $130^{\circ}$  F. The addition of one part of mineral oil to four parts of paraffin will produce a mixture whose melting temperature is lower than that of paraffin alone. For those who are thermally sensitive, the initial contact with the paraffin should be very brief, the part is dipped and then quickly removed. The first coat which is formed as the paraffin solidifies serves as a protection during subsequent immersions. Should the paraffin coat be cracked by the movement of a part it is possible

induced along the line even though the lightning does not strike directly. In cities where cables are placed underground, and particularly in buildings with many steel beams, this danger is negligible.

#### DANGERS IN THE USE OF VARIOUS PHYSICAL PROCEDURES

A knowledge of the limitations of physical therapy is as important as is the recognition of its possibilities. Physical measures should not be used when a pharmaceutical or surgical approach would be more effective.

The contraindications to the various forms of physical therapy are referred to in their respective chapters. Because of the importance of avoiding injury to the patient, it may not be amiss to discuss here the specific dangers, even at the cost of some repetition.

*Exercise.* Before exercise is prescribed, the patient should have a physical examination with particular attention paid to heart action, blood pressure, and pulse rate. Exercise which is too strenuous can cause continued acceleration of the pulse, dyspnea, abnormal breathing, or signs of fatigue. Slight tiredness which may help to induce relaxation is a normal reaction to exertion; too severe exercise, which causes a feeling of great tiredness and exhaustion, is to be avoided. Exercise of muscle groups which have not been used actively for some time will produce some stiffness on the following day. Development of severe muscle soreness indicates that the exercises have been too strenuous. Stiffness unless it is unusually severe, is not a contraindication to the continuation of exercise. On the contrary, certain activities such as loose swinging exercises, will help reduce stiffness. To avoid the danger of muscle strain, exercises should be light at the start; and gradually increased until the stretching is performed vigorously. Finishing the exercise session with those movements which cause relaxation of muscles may help to prevent a feeling of soreness. So also does a hot bath. Hot compresses are also of value in giving relief to sore muscles.

Patients should not exercise until at least one hour after a meal. The patient who states that he feels uncomfortable when attempting to exercise directly after arising should be advised to perform his exercises at a time which he finds more suitable. Since exercise produces peripheral vasodilatation and, at times, elevation of body temperature, the patient should not expose himself to a cold environment until he has had an opportunity to "cool off." A patient suffering from disease of the nervous system should be carefully watched and adequately supported at all times, inasmuch as his sense of balance and direction is frequently impaired.

*Ultraviolet Radiation.* A not infrequent danger of ultraviolet radiation is

folded, the thicker surface provides a firmer hold for the clip. A break in the cable which connects the plate to the machine may give rise to faradic sensations. The rubber covering of the cable in the region of the break may be burnt through so that the patient may be injured if this part of the cable is in contact with the skin. Cables should be inspected at intervals to insure against the possibility of a break, unusual bends or flexibility in the cable are indicative of fractured wires. Loose contacts and breaks may cause the cable to become hot in spots, and such overheated areas should be carefully inspected. If the surface of the metal plate is not smooth, there may be a dangerous concentration of current.

If a patient falls asleep during the course of a long wave diathermy treatment, a sudden noise such as the ringing of a door bell may startle him so that he involuntarily jumps away from contact with the metal plate, and the resulting arcing may cause a burn. Every effort, therefore, should be made to eliminate sudden, loud noises. Glass electrodes present a special danger when used for orificial application because of the possibility of their breaking, it is better to use a metal electrode for treatment of the orifices. A short circuit produced through the accidental contact of two wires, or in some other way, may damage the diathermy machine. The meter may burn out unless protected by a special fuse, and for this reason, it is frequently disconnected from the circuit when diathermy current is used for surgical purposes.

Patients undergoing treatment with high frequency currents (with long or short wave diathermy) should avoid contact with any grounded object. Metal strips in the wall adjacent to a treatment table may furnish such a ground, and their presence may be overlooked because of the fact that they are covered with paint. Some floors are good electrical conductors, particularly those which have much metal within them, a layer of insulating material may help to correct this difficulty. If defective insulation causes a short circuit between the primary and secondary windings of the transformer, the patient may receive the current directly from its line source.

Ignition of a highly explosive anesthetic mixture by an electric spark has caused disastrous explosions in operating rooms. Elaborate precautions are therefore taken to avoid the occurrence of such sparking. When the high frequency current is used for surgical purposes, anesthetics such as ethylene and cyclopropane cannot be employed. For anesthetized patients, the dispersive electrode should be large and it is important that it be kept in good contact with the skin.

Occasionally, some anatomical distortion may make it inadvisable to use a particular technique. For example, with marked flexion contractures of the

that subsequent dipping into paraffin may cause overheating of the skin in the region of the cracks. Care should be taken that water is not mixed with the paraffin, as water heated to these temperatures can produce burns.

*Hydrotherapy.* The temperature of the water in therapeutic baths must be carefully regulated. A temperature above 110° F. is intolerable to many persons, and may cause a dangerous elevation of systemic temperature. Locally, some individuals can tolerate water as hot as 115° F. A full immersion bath may prove injurious to a cardiac patient. In the presence of cardiac disease, pressure of the water on the abdomen and thorax with its resultant restriction of respiratory movement, places an additional load on the cardiovascular mechanism. In the presence of peripheral vascular disease, it is particularly necessary to avoid foot baths which are either too hot or too cold.

*Phototherapy and Infra-red Radiation.* The possibility that a lamp may fall should be kept in mind. Lamps occasionally become loose in their sockets; they should be inspected at frequent intervals to make certain that they fit tightly. Phototherapy lamps may loosen at the point where the glass is cemented to metal. Rarely, a lamp may explode, and therefore it should be protected by a screen. The diminution in thermal efficiency is more than overbalanced by the insurance against injury. Since infra-red elements have been known to melt, these lamps should be so placed that any melting part will fall to the side of the patient and not directly on him. Patients occasionally faint while undergoing cabinet bath treatments; if there is any suspicion of thermal intolerance because of the presence of disease or because of some unusual sensitivity, the treatment should be brief. A cold cloth around the head helps to prevent fainting. The mechanisms in thermostatically controlled heating hoods stick occasionally, so that the temperatures developed in the hood are higher than desired. A thermometer placed within the hood serves as a check on the working of the mechanism; it should be inspected at frequent intervals to make certain that the apparatus is functioning properly. As hoods are employed for the treatment of peripheral vascular disease, the deficiency in circulation makes it particularly necessary that too much heat be avoided. When the circulation is severely hampered, as by an embolus, it is best to avoid all forms of heat, or even to resort to the application of cold.

*Long Wave Diathermy.* When diathermy is used, a break in the patient's circuit can cause arcing and a resultant burn. Sudden separation most frequently occurs at the point where the clip is attached to the metal plate. The operator should make certain that the clip is fastened tight enough so that the pressure of the body will not loosen it. If one edge of the plate is

the treated region Sweating of the area under the electrode and the contact of the cable with the bare skin are the commonest causes of burns in short wave current therapy Metal objects such as hairpins, earrings, buttons, watches, and the like, tend to concentrate the electrical field, bringing about local overheating However, metal embedded within the tissue does not appear to have the same effect, provided such an object is not connected by a wire leading outside the field to a ground Thus, current can be safely applied to the region of the mouth even though there are metal fillings in teeth Schmitt, of Philadelphia, successfully applied short wave diathermy to the region of the hip in instances in which a vitalium cup had been placed over the head of the femur Wet dressings on the treated region may become highly heated by the flow of current, therefore they should be removed before treatment is started Dry dressings may be permitted to remain in place Ointments should be removed as they may interfere with electrical factors

Breaks in the cables conveying the short wave current may escape detection because of the rubber covering They are most likely to occur at the point where the wire is joined to the metal plate contained within the short wave electrode Manufacturers have made every effort to eliminate this weakness in the apparatus, but breaks still occur at times When coil techniques are used, care should be exercised to prevent the coils coming in contact with one another and thus producing arcing and burns The short wave current should not be applied through a solid cast Metal adjacent to the field can cause burns, fires have been produced in mattresses containing metal springs when patients were treated in bed

If several high frequency machines are connected to one line, turning some of them off may increase the current to the remaining machines, and, conversely, turning several machines on may lower the current In some short wave machines the voltage may be adjusted to avoid these line fluctuations With high frequency as well as with other treatments, all controls should be turned back to zero at the end of the treatment This will avoid the danger of starting the next treatment with a sudden application of a considerable amount of current

Helliwig calls attention to a legal decision establishing the physician's responsibility in the application of the short wave current In this case a paronychia was treated with the short wave current A burn occurred on the large toe In the testimony, the medicolegal consultant approved the use of short wave diathermy in this particular case, but pointed out that the electrodes had been improperly applied, and that the patient had not been

elbow, cuff electrodes placed above and below the elbow can cause overheating of the tissues on the flexor aspect. In such cases another technique should be substituted. It is possible to produce burns in the subcutaneous fat without evidence of damage in the overlying skin. I have seen the development of painful nodules in the suprapubic region to which a plate electrode had been applied in an attempt to secure a high temperature within the pelvis. The second electrode had been placed intravaginally. Nodules so developed may be painful for a period of several weeks.

Diathermy (as other methods of heating) should be applied cautiously in the presence of acute inflammatory states.

*Short Wave Diathermy.* Overdosage with the short wave current must be guarded against. It is possible to aggravate acute conditions by application of too much energy. In the acute stage of subdeltoid bursitis, for instance, the patient's pain may be made excruciating by application of even slight intensities of the short wave current. On the other hand, in the more chronic stages of the disease this current may yield excellent results. In a case of trigeminal neuralgia I observed an increase of pain after the short wave current was applied with mild intensity and improvement when the current strength was reduced. Overdosage may produce particularly unfavorable results in cases of disturbance of the peripheral circulation. When too much current is applied, the treated limb may become cyanotic; whereas with small amounts the circulation may be definitely improved.

The startling effectiveness of short wave diathermy in some types of local infections has been cited as proof that a non-thermal factor is responsible for the beneficial results. Relatively small intensities may bring about rapid disappearance of the lesion. I have also seen dramatic improvement in local infections following the use of radiation from a luminous source, such as a tungsten filament lamp. It seems reasonable to believe that the improvement which takes place may be attributed to the physiological changes produced by heat, rather than to direct thermo-lethal action on the micro-organisms. I have observed one case in which the patient had abscesses at two separate times. The first abscess responded to short wave diathermy with dramatic improvement; the second abscess was markedly aggravated by the same treatment. Obviously the dosage was correct for the infection at one stage, and too strong at the other; it should have been different on the two occasions.

As there is no inexpensive and satisfactory meter available to indicate the amount of current in the patient's circuit, the strength of the current must be judged from the patient's thermal sensations. It becomes essential, then, that the physician make certain that thermal insensitivity does not exist in

vanic current is applied Scars should be treated with special caution, especially where iontophoresis is used

*The current coming from the galvanic machine* may be modulated by the rheostat As the rheostat knob is turned, the current gradually increases in the patient's circuit If the device which stops the sliding contact on the rheostat from going beyond its end is worn, the metal contact may slip from the starting position to the "full on" position, with a resultant severe shock to the patient when treatment is started

*War Injuries* Unlike previous wars, the second World War is responsible for injuries among the civilian population as well as the military forces In the treatment of these injuries physical therapy may be used much as it is for the conditions and diseases described in this text Beaumont calls attention to some of the common disorders produced among the people of England as a result of bomb attacks Cases of *musculospiral paralysis*, including wrist drop, have occurred, due to the habit of sleeping on chairs, in subways, and in bomb shelters An arm that has hung over the back or side of a chair for prolonged periods of time may show typical "crutch paralysis" These patients were treated with infra red radiation followed by application of the surging galvanic current sufficiently strong to produce general contraction of the muscles The arm was carried in a sling for a time and the patients were instructed in graduated exercise designed to restore the function

Carbuncles and multiple abscesses also occurred frequently The short wave current was applied to these for twenty minutes twice a day At the end of from five to ten days, when pus formation had ceased, ultraviolet radiation was administered to produce a second degree erythema For small lacerations caused by shattered glass, mild erythema doses of ultraviolet radiation have been given to produce a natural scab over which the granulation tissue could develop Rheumatoid fibrositis developing from sleeping in damp cellars and shelters was treated with infra red radiation for twenty minutes at a time followed by movements and massage Persons suffering from mild bomb shock have been given hot, acrated brine baths, followed by massage

*Electrical Shock* The possibility of producing damage with commercial current lines always exists Fatal accidents can occur as a result of contact with 110 volt electric circuits present in homes Accidental grounding of a person may occur This danger is increased when the floor is wet or when one hand is in contact with an electric light socket and the fixture connected to it Dry skin offers considerable resistance to the passage of electric cur-

under constant supervision during treatment. The practitioner was convicted by two courts. It was stated that the patient should not have been left alone while the treatment lasted, and that he had not been given exact directions as to his behavior during the application of the current.

*Galvanic Current.* The danger of causing local tissue destruction is perhaps greater with the galvanic current than with any other physical therapeutic procedure. The surface of the electrode in contact with the skin should always be moist; if it dries out or if there is a break in the surface so that the skin comes in contact with the bare metal of the electrode, a burn may occur. Galvanic burns are generally small and usually of no particular consequence. They may appear as small blebs. However, if the damaged area is sufficiently large, the resulting indolent ulceration tends to heal very slowly. Galvanic destruction of tissue may occur without causing the patient enough discomfort to cause him to complain. When he does complain of discomfort, the treatment should be immediately discontinued, the site of application examined, and the electrode readjusted if necessary.

In some forms of application, and particularly in epilation, it is essential that the electrode be connected to the correct pole of the machine. If a steel needle, used for epilation, is connected to the positive pole of the machine, a permanent tattoo mark may result. The operator should make certain of the polarity of the needle electrode. This can be done readily in either of two ways: by immersing the ends of the electric cords in salt solution as described on page 221, or by touching them to a strip of paper moistened with phenolphthalein solution. In this latter test, the alkaline nature of the reaction around the negative pole causes the negative terminal to produce a red mark on the paper. Red and black or blue electrical cords are conventionally used in order to avoid the confusion which may result when the cords become twisted. The red cord is attached to the positive terminal and the blue or black to the negative one.

Machines producing galvanic current should be so constructed that a smooth current is induced. With these machines, as with other medical apparatus, the patient's circuit should be ground-free. When the source of energy is the alternating current, this can be accomplished readily by transformers, converters, or rectifying tubes. If the current is direct, the machine can usually be rendered ground-free by means of a direct current motor generator set. When direct current apparatus is not so constructed that it can be made ground-free, the danger of injury to the patient can be minimized by the use of fuses and resistances. The physician should be certain that there is no thermal sensory disturbance in the area to which the gal-



## CHAPTER XVI

# DISEASES OF THE LOCOMOTOR SYSTEM

**P**ERSONS COMPLAINING OF SYMPTOMS ATTRIBUTABLE to disorders of the musculoskeletal system probably form the largest group of patients seen by physicians practicing physical medicine, and the relief afforded by physical measures is probably greater in these than in any other disorders. As in other diseases, physical therapeutic procedures should be based on knowledge of the patient's condition as a whole, and should be used in conjunction with whatever medical and surgical measures may be necessary. The fact that heat in one form or another is beneficial in diseases of the locomotor system does not lessen the need for an accurate diagnosis if maximum improvement is to be secured. A carefully taken history and a thorough physical examination are prerequisites for treatment.

### ARTHRITIS

*Inflammation in and about the joints has a varied etiology. Its therapy must be correspondingly varied. The two most common types of arthritis are "rheumatoid" or "atrophic," and "osteoarthritic" or "hypertrophic."*

### ATROPHIC ARTHRITIS

Because of its prevalence and the uncertainty regarding its causative factors, many forms of therapy have been advised for atrophic arthritis. Atrophic arthritis is a systemic disease with local manifestations in the joints. A focal infection in some other part of the body has been demonstrated as the derivative source in isolated instances. But, in general, the theory that focal infection is the causative agent appears to be on the wane. So also is the concept of an allergic basis. Numerous pharmaceutical preparations have been employed in the effort to bring about improvement in the systemic background of arthritis.

Physical therapeutic procedures which are used extensively in the symp-

rents particularly if it is thick and hard. Moist skin presents no such resistance. Accidents have been reported as occurring in bathtubs when the bather has touched a charged fixture or wire. Patients connected to electromedical apparatus should avoid touching radiators, water fixtures, and the like. Electrical accidents in the home can occur because of defective insulation of domestic appliances such as electric irons, mixers, washing machines, vacuum cleaners. The danger is increased if the heart is in the path of the current flow.

Individuals who desire to help a person who has come into accidental contact with high voltage wires should exercise caution as to the manner in which they remove the injured person. They should not touch that person unless the danger of shock to themselves is avoided. If it is possible to turn the current off immediately, this should be done. Otherwise, the wires may be pushed away from the injured person by means of a long stick, provided the stick is dry and the ground is not wet, or insulated rubber shoes and gloves must be used. Another possibility is to short circuit the current so as to discontinue the current flow to the injured individual. Death which occurs from such accidental electrocution is usually ascribed to cardiac fibrillation or to respiratory paralysis. A person who makes accidental contact with charged electrical wires may not be able to let go of them because the stimulation of his flexor muscles prevents him from unclenching his hands. After the patient has been removed from the electrical contact, artificial respiration should be applied, if necessary, and maintained for several hours. Fisher describes the "pole top resuscitation" method designed by Oesterrich to permit application of artificial respiration to linemen who have received shocks while at work on electric pole tops. The use of oxygen in resuscitation may help. The burns produced by the current may be very extensive.

as the patient lies in the bathtub, or on a suitably protected bed (Fig 19)

Vrtak and Kobak found applications of heated mud to be of great value in the treatment of arthritis. The beneficial effect is due to conductive heating and to the slight pressure of the weight of the mud. The average length of single mud applications which these authors used was thirty minutes. The average temperature of the mud when applied to the body was  $49^{\circ}\text{C}$ , at the end of treatment, it was  $41.5^{\circ}\text{C}$ . Since mud applications are messy, paraffin baths may be substituted.

*High Frequency Currents* Procedures that are simple enough to be readily applicable at home have the advantage of making frequent treatments possible, but if the patient is ambulatory, he should go to the physician's office or the clinic for additional treatment with diathermy and the short wave current. Depending on the factors involved, such treatments may be administered daily, every other day, or twice a week. High frequency current energies are applied to the point of comfortable heat tolerance for periods of from twenty to thirty minutes. As they may cause exacerbation of the symptoms, it is advisable to use small intensities for shorter time periods at the initial treatments and to increase them gradually.

The technique of the application of the short wave current must be adapted to the region involved. For the joints of the extremities the electrodes may be placed parallel to each other, either laterally or in the antero-posterior position. The most effective heating is obtained by placing flexible cuff electrodes around the limb above and below the joint, or by winding a coil around the joint. Overheating must be guarded against (Fig 247). For the shoulder joints, flexible or solid plate electrodes may be placed anteroposteriorly, or one electrode may be applied on the arm below the joint and the other on the region of the neck and shoulder above the joint. A pancake coil, saucer shaped, placed with its concavity toward the shoulder is also an efficient electrode. When the small joints of the hand are involved, the forearm may be placed on one electrode as it rests on a table, while the finger tips are put on the other electrode (Fig 248). Spacing is secured with non-conducting material. In treating the hip joint a semi-cuff electrode is placed around the outer half of the thigh, and a belt electrode is wrapped around the waist (Fig 249). The small joints of the foot and ankle can be treated with one plate beneath the sole of the foot, and the other, a cuff electrode, wrapped around the leg above the ankle. This latter electrode may be replaced by one put under the region of the calf as the patient lies on the table (Figs 250, 251).

In the cervical spinal area the condenser plates may be placed on either

tomatic treatment of this disease include applications of heat and cold, counterirritants, immobilization, mobilization, massage, and occupational and postural exercises. Physical procedures advised in the effort to alter the systemic background include changes in climate, relaxation brought about by rest, removal of psychic irritations, ultraviolet radiation, baths, and colonic irrigations.

The acute stage of atrophic arthritis may be characterized by swollen and tender joints, elevated systemic temperature, and increased sedimentation rate. The primary requirement in this stage is rest. Local application of heat may increase pain. Abstraction of heat by means of cold compresses and ice bags may be helpful. Physically induced fever can cause improvement. It is in the subacute and chronic stages of atrophic arthritis that physical measures have proved beneficial.

*Local Heating.* When only one joint or a few joints are involved it is feasible to apply heat locally. Both conductive and converse thermal methods are of value. Conductive transference of heat may be obtained by means of hot baths, hot compresses, hot dressings or half-saturated solution of magnesium sulphate, steam, hot water bags, heated pads, heated mud and paraffin. These procedures are indicated particularly in arthritis involving the hands and the feet because the ratio between surface area and mass is large. In other regions more efficient heating is secured from converse sources such as diathermy and short wave currents. Radiant energies from lamps provide a convenient source for a combination of conductive and converse heat. This type of heating, and others such as hot compresses and heated mud, can be employed when the acuteness of the inflammatory reaction precludes more strenuous forms of heating.

Contrast baths in which the part is alternately exposed to hot and cold water are advocated by some authorities. Woodmansey found that active contraction and relaxation of blood vessels and increased blood flow is most effectively obtained when hot water is applied for six minutes and cold water for four minutes. He considers that increase in circulation is an important part of the treatment, because in his opinion atrophic arthritis may be a disease of infective origin in persons with constitutional and vascular defects. A common technique for administration of contrast baths consists in immersing the part first in hot water ( $105^{\circ}$  to  $110^{\circ}$  F.) for about one and one-half minutes and then in cold water ( $60^{\circ}$  to  $70^{\circ}$  F.) for about one-half minute. This is repeated about ten times, beginning and finishing with the hot water. Contrast baths may be applied to areas other than the distal portions of the extremities by playing hot and cold sprays against the area

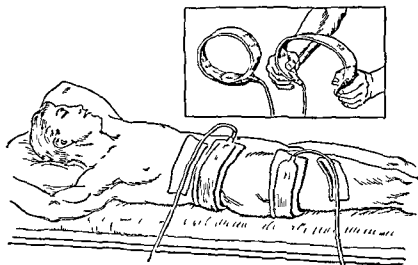

FIG 249 Short wave current applied to region of hip Metal spring cuff electrode covered with insulating material placed above and below the hip joint.

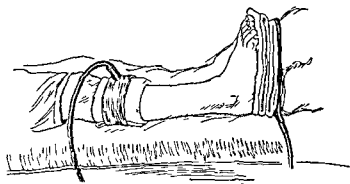

FIG 250 Short wave current to foot and leg Flexible electrode is under the calf, the other electrode is under the foot.

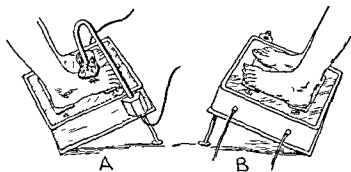

FIG 251 A convenient apparatus for the application of the short wave current to the feet  
 A One air spaced electrode is over dorsal surface of foot The other under plantar aspect of toes and separated from foot by a plate of glass  
 B Coplanar technique Both electrodes are placed under plantar aspect of feet and covered with glass plate on which the feet rest

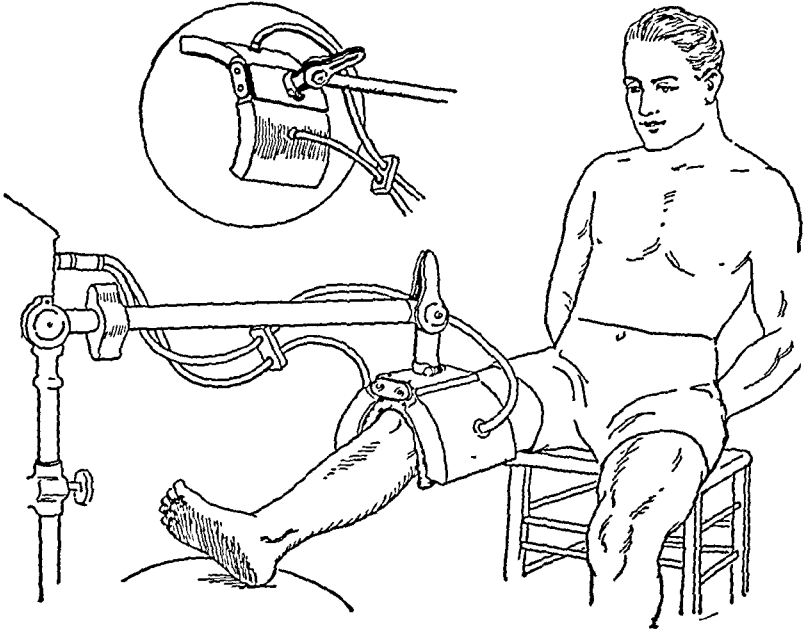

FIG. 247. Short wave current applied to knee. Coil in flexible drum surrounding knee.

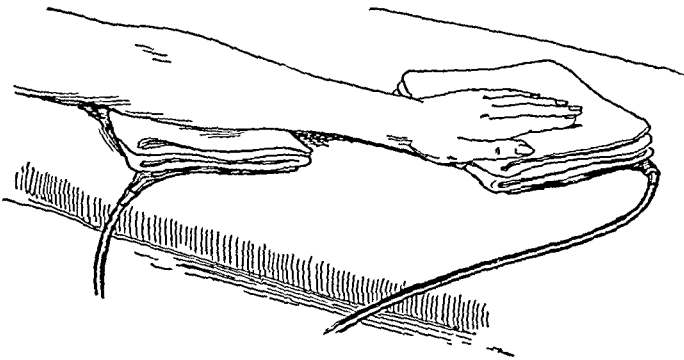

FIG. 248. Short wave current applied to hand and forearm. Flexible condenser electrodes under fingers and forearm. Towel spacers

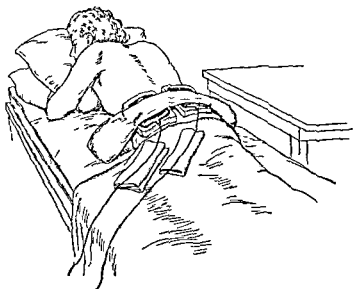

FIG 252 Short wave current to sacro iliac region Saddlebag shaped sandbag holds coplanar sacro iliac electrodes in place

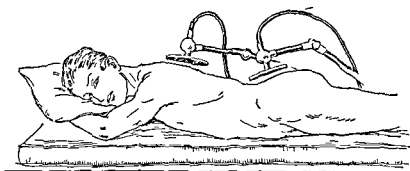

FIG 253 Short wave current to region of spine Air spaced rigid electrodes are disposed in coplanar fashion along spine

side of the neck, or the coil technique may be employed. The condenser plates may also be placed in the anteroposterior position, one on the back of the neck, and the other on the neck and chest. For the cervical dorsal portion of the spine, the electrodes may be applied longitudinally on either side of the spine in the coplanar position, or anteroposteriorly. In many instances pain distribution along the upper extremities is due to arthritic involvement of the cervical-dorsal vertebrae. In such cases one condenser electrode is placed on the side of the spine opposite the involved extremity, while the other electrode is placed on the painful arm or forearm. In the treatment of localized regions of the spine such as the dorsal or the lumbar or dorsolumbar, the coplanar technique may be used either in the longitudinal or transverse position, or the anteroposterior arrangement can be applied (Fig. 252). If the entire spine is involved, one condenser electrode is placed over the cervical area and the other over the lumbosacral region (Fig. 253).

When flexible electrodes are used, the patient should lie on his back, separated from the electrodes by some substance such as felt, towels, or sponge rubber. With air-spaced rigid electrodes, the patient should lie prone on the table. If the wave length is short enough, effective treatment can be administered with both electrodes beneath the table and the patient in the supine position. One long, narrow electrode placed along the spine and the other larger one placed anteriorly does not afford a satisfactory application.

Symptomatic improvement of the pain of intervertebral arthritis in response to short wave therapy is sometimes impressive. In some instances pain has been alleviated even when changes or complete bony fusion have been roentgenographically demonstrated. Obviously the bony changes have not been influenced by the treatment, and therefore it may be concluded that the improvement is due to the effect of the heat on the surrounding soft tissue which is the seat of the painful sensations.

Lower back pain due to inflammation in the region of the lumbar vertebrae or of the sacro-iliac joints may be relieved by the short wave current. In these conditions there may or may not be accompanying radiation of pain along the distribution of the sciatic nerve. Treatments at comfortable tolerance are administered for from twenty to thirty minutes. If there is radiation of pain along the course of the sciatic nerve it is advisable to include the painful region between the two electrodes—one placed above the sacro-iliac area and the other below the region of pain distribution (Fig. 254).

*Galvanic Current.* I have obtained better results in atrophic arthritis with conversive heat than with the galvanic current and its modifications. However, there are cases in which the unidirectional current, either alone or with



been advised. It is problematical whether iontophoresis with these drugs has a special value other than that of the galvanic current itself.

The interrupted galvanic current has been employed to counteract the muscle atrophy and sluggish circulation associated with atrophic arthritis. The faradic current, or its modifications such as that secured from the Smart-Bristow coil, is useful. So also is the sinusoidal current. These currents can be applied through moist pads or through solutions into which the extremities are placed as in the Schnee four cell bath (page 227).

*Immobilization of Joints* If the inflammatory process is acute, rest for the inflamed joint is essential. A compress of an anodyne solution helps to relieve pain. Splints which partially surround the involved area may be applied to insure rest and to prevent possible development of deforming attitudes. It is not usually necessary to use a completely encircling cast, which has the disadvantage of preventing application of heat and massage. Complete immobilization is an orthopedic measure which may necessitate the use of appliances such as casts, braces, Bradford frames, and extension splints. With milder manifestations of the disease, partial immobilization is sufficient. This may be accomplished by elastic supports to the knee and ankles and by sacro-iliac belts. If the patient suffers from static disturbances of the feet, he may require the assistance of a transverse or longitudinal arch support, or special shoes.

Exercise therapy in atrophic arthritis requires careful consideration, for if active movements are started too soon, pain and muscular spasm will develop. In the beginning, exercises should be practiced without weight-bearing. Weight bearing should be begun only when enough range of motion has been obtained to permit sufficient extension and flexion for reasonably good function and when the muscles have resumed reasonably normal contour and are of sufficient tone to maintain the weight of the body. The purpose of the exercises is the restoration of function in the joints. Some of these exercises can be followed more pleasantly in games and occupational activities. Swimming is an especially good form of exercise for arthritic patients.

According to Bradford the following principles should be observed in prescribing exercises for arthritic patients: (1) avoidance of strain, (2) progression according to the ability and limitations of the patients, (3) progression within the exercise, (4) initial passive motion changing into assisted motion and then, into active motion, (5) use of rhythm to help unaccustomed and monotonous repetition carry itself, (6) a daily program to coax

the addition of chemical substances, appears to exert a more beneficial effect. In the usual galvanic technique the electrodes are applied to either side of the involved joint. When this arrangement is not practical, the positive pad

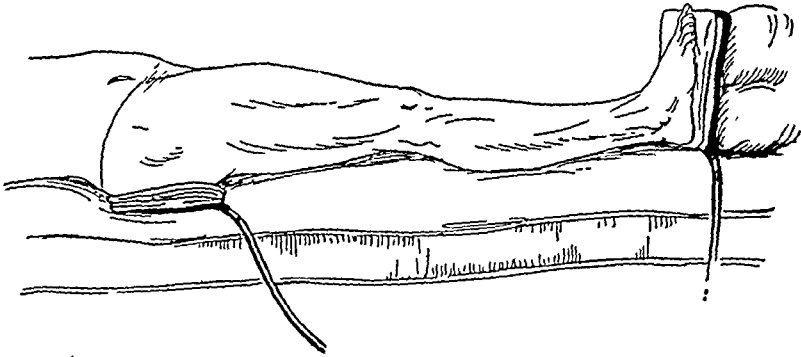

FIG. 254 Short wave current applied to lower extremity. One electrode is placed over the region of sacro-iliac and buttocks; the other, under the foot.

is placed over the area of the diseased joint, and the negative, on the upper or lower back or on some other region. An arrangement effective in some cases of arthritis is the galvanic bath to the entire body.

Electrophoresis with histamine or acetylbetamethyl choline chloride appears to increase the effectiveness of the galvanic current. A more profound change in the circulation of the skin surface is apparent when these medicaments are used with the galvanic current than when the current alone is used. Histamine can be applied as a solution or in ointment form. For the small joints of the fingers, asbestos paper moistened with histamine may be wrapped around each of the involved digits. Strips of pliable metal are wound around the wet asbestos paper and connected to the galvanic machine. Galvanic current applications can be used in conjunction with heating measures.

Boyd noted that mecholyl iontophoresis was of great value in the treatment of patients with circulatory disturbances of the extremities, who showed cool, pale, moist, and often cyanotic hands and feet. He obtained the maximum effects after eighteen or twenty treatments. After the first treatment, from 40 to 50 milliamperes were administered for twenty minutes. A 1 per cent solution of the drug was employed. Acetylbetamethyl choline chloride is now also available in ointment form. Bee venom ointment has been applied by iontophoresis. In 27 cases of chronic atrophic arthritis in which this form of treatment was administered, Descoedres reported that 1 was cured, 15 were improved, and 11 failed to derive benefit. Iontophoresis of other chemical substances such as the salicylates, iodides, and lithium has

physical methods have the advantage of permitting more exact control in degree and duration. The hot full wet pack can often be applied to the arthritic patient who cannot be treated with hot baths. The technique for such a pack is described on page 47.

In acute rheumatic fever the results achieved by physically induced elevations of temperature are excellent. The joint pains and swelling recede promptly, the temperature reaches a normal level, and the sedimentation rate diminishes. The presence of rheumatic carditis does not contraindicate the method unless there is evidence of grave cardiac pathology.

*Massage* Massage is of value for both its local and general effects. An acutely inflamed joint should not be massaged. For chronic arthritic conditions, massage daily or three times weekly is pleasant and helpful, not only because of the physical changes which it induces, but also because of the psychic benefits gained from the feeling of relaxation.

*Ultraviolet Radiation* It is probable that several factors are responsible for the improvement in atrophic arthritic conditions brought about by ultraviolet radiation. The physical changes produced include local vascular alterations, skin pigmentation, and the stimulation of calcium metabolism through the increase of vitamin D. When ultraviolet radiation can be secured from its solar source, there are the added advantages of photothermal and climatic influences. These effects may account for the benefit which many arthritic patients receive from a warm climate. If other methods of treatment prove ineffectual, the physician should suggest such a climatic change. If this is not possible, ultraviolet radiation can be secured from artificial sources.

*Colon Irrigation* The value of colon irrigation in the regime of the arthritic patient is a moot question. Certain it is that the vogue for colonic irrigation has diminished considerably. The idea that the lower bowel might be the site of the origin of arthritic conditions is not as commonly entertained now as it was formerly. Nevertheless, many of these patients appear to be benefited by colonic irrigations. The explanation may lie in the increased encouragement to bowel movement. Some physicians attempt to change the bacterial flora by implantations following the colon irrigation. It is probable that some benefit which arthritic patients experience from a sojourn at a spa is due to improvement in bowel function brought about by imbibition of water with mild cathartic action.

*Spa Therapy* Undoubtedly, a vacation at a spa does help many arthritic patients, and it is regrettable that the spa habit is not as common in this country as it is abroad. When wider attention is called to the value of spas and when they are able to achieve the pleasant and relaxing influence of

handicapped patients already fatigued to carry through. Hartung emphasizes the need for postural training. He believes that lumbar lordosis with associated pelvic tilt is the foundation of defective posture, and that conscious control, especially of the gluteal and abdominal muscles, as well as exercise is necessary to correct the curvature. Exercises to correct lordosis have already been outlined (page 341). Occupational activities described in Chapter VIII are also useful, not only as a form of exercise but for their psychological and rehabilitational influences.

The most effectual movements are voluntary. At times, however, it may be necessary to assist the patient to increase the range of excursion of voluntary movement. Such assistive motion must not be overdone. A mildly painful response to manipulation, lasting not longer than a few hours, does not contraindicate repetition of manipulative procedures; severe pain lasting for more than a day indicates that ministrations have been too vigorous, and when resumed should be milder. In atrophic arthritis involving the cervical vertebrae, manipulations with the assistance of a head sling cause diminution in the sensations of discomfort experienced in the region and also in the radiating pain in the upper extremities.

*Immersion Baths.* The immersion bath is a valuable procedure which permits the patient to move joints voluntarily to a maximum degree and at the same time exerts a thermal influence on the entire body. Special tanks have been constructed sufficiently large to allow for motion of the extremities. Less expensive tanks can be constructed by local tinsmiths, or a relatively inexpensive tank designed for other purposes can be purchased. The ordinary bathtub permits only a limited range of movements, but within this range, motion may be of value.

*Fever Therapy.* The temperature of the water in the tank or tub should be about 97° F. at the beginning of treatment; it can be gradually increased to 104° or 105° F. Such temperatures are enervating. If they are tolerated, immersion for ten to fifteen minutes may cause an elevation of rectal temperature to about 102° F. The patient may then be returned to a bed, the coverings of which have been preheated. If wrapped snugly, his temperature will gradually decline to the normal level.

This procedure is a good one for developing mild fevers. It is comparatively simple and inexpensive. If the systemic condition permits, hot baths can be applied every night or every other night; or twice a week may be sufficient. In many instances, a temporary improvement occurs; in a few, it persists. Although systemic temperature can be raised by physical methods or by intravenous injection of a foreign protein such as typhoid vaccine,

vasodilating procedures such as galvanism and its modifications, are of value, as is massage and exercise. Much relief can be given by improving the condition of the soft tissues, even though the bony changes are irreversible. The type of arthritis which occurs in women at the time of menopause is treated with the same physical measures. If there is an associated endocrine deficiency, substitution therapy should be instituted. In the arthritis of gout, changes in metabolism should be induced by dietary and pharmaceutical measures. However, I have seen mild heating with a lamp followed by static brush discharge give quick relief when colchicine had failed to do so. In tuberculous arthritis, the therapeutic regime must include the general hygiene and dietary care required by the systemic background as well as treatment of the local orthopedic conditions. In this disease, heliotherapy and ultraviolet radiation from artificial sources are of great therapeutic value.

In gonorrheal arthritis brilliant results are achieved by adequate elevations of systemic temperature. Administration of the sulfonamides may be sufficient to destroy the gonococci. In cases in which this therapy alone is not adequate, successful results can be achieved by use of these drugs in conjunction with physically induced fever, or by physically induced fever alone. Restoration of joint activity can be hastened by subsequent use of local heating, massage, and exercise. The treatment of syphilitic arthritis is that of the systemic infection. Locally applied physical measures are of little value.

Physical measures can produce excellent results in traumatic arthritis. The injury may be direct, or indirect as a result of dislocation. The initial care usually requires rest achieved with or without splinting, strapping, or bandaging, mild warmth or cold and effleurage. After the first twenty four hours, when the very acute symptoms have subsided, heat, massage and voluntary motion assist in the resolution of the traumatic pathological changes. The heat treatments may be conductive (hot baths, hot compresses) or convulsive (lamps and high frequency current generators). The period of immobilization, complete or partial, depends on the extent of the damage to tissue in and about the joint.

## INFLAMMATION OF MUSCLES AND FIBROUS TISSUES

### FIBROSITIS

Muscle and fibrous tissues may be the seat of acute and chronic inflammatory reactions of either traumatic or non traumatic origin. Fibrositis is also referred to as myalgia, myositis, myofascitis, and lumbago. Pathologically, the condition appears as fibrosis of the muscle reticulum with development

many of their European counterparts, it is probable that their facilities will be more often sought. The psychological benefit to be derived from a spa is important. Contact with sympathetic fellow-sufferers, appreciation of the elaborate organization designed for his benefit, the daily routine arranged to occupy his day in a pleasant and beneficial manner, removal from the locale of his business and social worries, all contribute to relaxation of mind and emotions.

However, since relatively few arthritic patients are able to go to spas and those who can usually do so during only two or three months of the year, the physician should encourage as much as possible the hope of improvement even though improvement be slow and over a long period of time. The practitioner may even assume, to advantage, the role of father-confessor. Gordon considers that emotional disturbances create changes in the functions of the body which may be causative agents in the production of chronic atrophic arthritis. The abnormal autonomic nervous system causes changes in the circulatory and secretory organs and in the tone of the smooth muscles, and also derangement of bodily functions as a result of modifications of postural tone and activity of the skeletal musculature.

The value of spa therapy has sometimes been attributed to special properties of the water, such as sulphur or radium emanations; and also to the general influence of hydrotherapy, which, it is believed, has a favorable action on the disturbed vegetative nervous system of the arthritic patient. Balneotherapy, according to Fritz, is primarily irritation therapy caused by some acetylcholine-like substance. The initial "bath reaction"—general fatigue, somnolence, mild fever, increased sedimentation rate, a shift to the left in the blood picture, and increased local pain—offers support to this theory. These reactive symptoms may fail to manifest themselves in subsequent treatments. Pennington classifies baths as asthenic (hot immersion baths, contrast douches, and mud packs), intermediate (spray massage or Vichy douche; local and general, dry and moist air applications), and thenic (pool bath, aeration bath, massage or air douche, tepid sitz bath, needle or shower bath).

#### OTHER TYPES OF ARTHRITIS

The care of osteo-arthritis (or hypertrophic arthritis) follows in general the therapeutic principles that govern the treatment of atrophic arthritis. Certain differences are based on recognition of the fact that hypertrophic arthritis is a degenerative disease. Conductive heating, as well as convulsive heating by means of high frequency currents, is used in osteo-arthritis. Other

and phototherapy may also be applied. Counterirritation created with mustard or with histamine iontophoresis is helpful. Dry cupping is an old-fashioned remedy which may give relief. Tender areas may be injected with

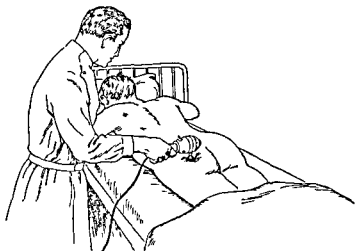

FIG. 255 Use of hand vibrator for treatment of fibrositis

a local anesthetic. This procedure will promptly relieve pain not only in the injected area but also in the regions to which the pain is referred from these trigger points."

In fibrositis which is due to poor posture, exercise and orthopedic care are required in addition to local measures such as heat and massage. If the fibrositis is generalized some universal method of heating such as the cabinet bath, hot tub bath, or hot pack should be employed.

Inflammation of the muscles and fibrous tissues of the back and of the neck may be responsible for occipital headaches. Headaches caused by fibrositis may be readily cured by physical measures, even though they be of long standing. Too vigorous treatment may cause temporary exacerbation of the inflammatory condition. Williams and Elkins noted that headaches can be due to pain that originates in muscles of the head and not to primary or secondary fibrositis. They term this syndrome "myalgia of the head." Treatment consists in application of heat from luminous heat lamps, high frequency currents, hot towels, hot packs, or paraffin. Hot body baths are of help. Heating of the part is followed by massage, at first of the sedative type—light stroking and kneading if the condition is acute, but preferably of the firm, heavy friction variety applied to the point of tolerance and concluded with sedative motions.

If, following massage of a muscle, the condition becomes worse, trichinosis should be suspected. In myositis ossificans, likewise, massage may increase

of specific deposits in muscles, which are said to resemble Aschoff's nodes. In the English literature the condition is described as a non-suppurative inflammation affecting the white fibrous tissues. This inflammatory process may be relatively acute or chronic, single or multiple, limited to small area or affecting areas of considerable size.

Hartung considers that the term "myositis" is a misnomer, since the site of the inflammation is the fibrous tissue between the muscle cells, the muscle bundles, and the muscle bellies. He believes that the inflammatory process affects the normal motions of these "muscle joints," thereby interfering with gross motion and circulation of the part, with resultant pain. He classifies fibrositis into three forms: primary, secondary, and pseudo. Primary fibrositis may be either infectious or traumatic; the traumatic type is further divided into the dynamic and the static. Weak feet and obesity, for example, cause static, traumatic strain with resulting fibrositis. *Pseudofibrositis* is seen in the neurasthenic, hypochondriac type of person who complains of vague aches and pains. *Secondary fibrositis* occurs as a sequela to arthritis.

The structures which are principally involved by fibrositis are the superficial and deep fasciae, aponeuroses, ligaments, capsules of joints, bursae, tendons, tendon sheaths, periosteum, and nerve sheaths. Palpation of tender areas may reveal indurations. These can occur in the muscles of the back of the neck, in the trapezius, and along the occiput, in the lumbosacral and gluteal regions, as well as in the calf and the abdominal and pectoral areas. A frequent site is the trapezius muscle, more commonly on the left side. The patient often gives a history of driving an automobile with the window down on the left side. The rapid rush of air as it enters the automobile may cause a lowering in muscle temperature (judging from our experimental evidence). Occasionally the patient suffering from acute torticollis states that he had a sore throat before the attack. It may be that in these instances the causative factor is microbic and related to the infection in the upper respiratory tract.

Relief is usually secured by use of heat and massage consisting first of light, superficial stroking, and subsequently deep stroking, kneading, and friction applied to the tender areas. As the tolerance increases the massage may be more vigorous. It should be persisted in for ten to twenty minutes. Vigorous motion of tissues can be induced by electrical vibrators and contractile currents such as the sinusoidal or the static (Fig. 255). In acute inflammation, vigorous manipulation may cause exacerbation of the condition; in such cases immobilization is a more satisfactory method of treatment. Conversive heat is effective in fibrositis, although hot compresses



the injured part, later, assistive and voluntary exercise will facilitate restoration to normal. Muscle contraction, stimulated first by the galvanic and later the interrupted current, helps toward healing. The contractile currents are the interrupted galvanic, faradic, sine wave, and static. Morton Smart emphasized the value of the surging faradic current in the treatment of recent injuries.

To secure prompt relief of pain and spasm following injuries, procaine hydrochloride may be injected into muscles and ligaments, or a spray of ethyl chloride may be applied, as the injured part is moved about. Kraus states that ethyl chloride anesthesia in conjunction with movement of the affected part may be employed successfully in sprains of all joints, acute muscular spasm due to lumbago, acute bursitis of the shoulder, pulled muscles, chronic muscular spasm due to low back pain, sciatica, chronic osteoarthritis, shoulder spasm and similar conditions. His method of conducting these treatments is as follows. The region in which pain is evoked by active motion is determined and ethyl chloride is sprayed on this area. The arc of movement is then carefully increased, and any new painful areas also sprayed. At the end of this treatment which lasts ten to thirty minutes, camphor liniment should be applied to prevent frostbite. Kraus states that "immediate normal use of the affected part can be allowed in a majority of cases, but excessive strain and sudden movement should be prohibited." Patients with the more severe disorders should rest after this treatment. All patients should be advised to continue the active movements for approximately five minutes at intervals varying from once an hour to twice a day. While a single treatment will be sufficient in cases of minor involvement, patients with more severe involvement will have to be treated several times, the first week, daily, later, every other day. To prevent frostbite he advises that camphor liniment and certain other oils be mixed with ethyl chloride. A mixture of ether, alcohol, acetone (100 parts of each) and camphor liniment (20 parts) is used after the spray.

Ruptures of a muscle or tendon require immediate surgical repair. If this is not feasible, then the part should be held in that position which minimizes the separation between the torn tissues. In such cases, physical therapy other than heat is contraindicated for a period of from six weeks to two months. When a muscle or tendon has been repaired, passive movement can be begun at the end of about two weeks. To counteract muscular contracture due to long standing trauma, forcible manipulation may be employed. Elastic traction furnishes a method for slow and continuous stretching.

Certain activities such as piano playing, writing, and typewriting some-

the discomfort. Persistent torticollis may be due to some ocular disturbance, or it may be a hysterical manifestation. Fibrositis may cause pain along the distribution of sensory nerves which traverse the involved area; for instance, "sciatica" can be due to fibrositis of the gluteal muscles and "brachial neuritis" to fibrositis of the muscles of the neck and upper back.

Herniation of fascial fat through weakness or actual deficiencies in the walls of its investing fibrous tissue can cause pain according to Copeman. Mylechreest, investigating the etiology and pathology of fibrositis of the back, found that the pain may be due to pathological changes found in these areas, namely edema of the fatty tissue, hemorrhage, congestion, or torsion of the pedicle of the prolapsed lobule; and that the release or removal of the prolapsed herniation of fascial fat may give relief.

#### MYOGELOSIS

Lange and Shade introduced the term "myogelosis" to describe painful, hard nodules occurring in muscles. Histological examination of these involved areas revealed no abnormal changes. The existence of these nodules is attributed to local colloidal chemical changes. Differentiation from "fibrositis" is made on the basis that in myogelosis, the nodules are present near the insertion or origin of muscles and never within the muscle belly and that their direction is along the course of the muscle fibers. Lange recommended treatment with what he terms "gelotriptic" massage, which is so severe that it produces hematomas. It is directed toward the muscle belly

#### INJURIES TO SOFT TISSUES

Treatment of traumatic injury of muscle and fibrous tissues depends on the degree and extent of the injury. If it is extensive and severe, the initial treatment should consist of rest and cold applications. These should be followed by some form of heat—hot compresses, hot baths, alternating applications of heat and cold, whirlpool baths, phototherapy, diathermy, or the short wave current—which will promote the absorption of effusions, relieve the pain, and so prevent atrophy of disuse. Overheating must be guarded against, as it may cause too great a degree of hyperemia without compensating lymphatic and venous drainage. The resultant increase in the inter-tissue pressures aggravates the patient's discomfort. Absorption of extravasated lymph and blood may be further accelerated by massage; starting with effleurage, more strenuous forms may be used as the acuteness of the condition subsides.

In the early stages it may be necessary to limit the range of motion of



FIG. 256 Manual traction applied to spine. The operator's hands under chin and occiput exert upward pressure.

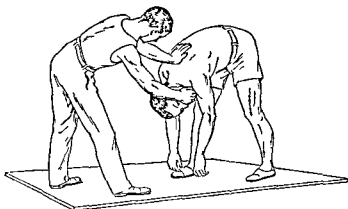

FIG. 257 A technique for manipulation of the cervical region. The subject stands with his legs wide apart and knees slightly bent. The body is bent forward with the arms hanging loosely. The head is held relaxed and in a dependent position. The operator with his hand on the chin moves the patient's head from side to side several times and then with a sudden motion twists it to one side to the limit of its excursion. At this time a click is frequently heard.

times cause muscle spasm. Rest of the involved part, including immobilization, if necessary, and the use of heat and massage, will cure this condition.

#### INJURIES TO ELBOW

Pain following trauma in the region of the elbow may be due to peri-arthritis, bursitis, or to rupture of tendon attachments, ligaments, periosteum and muscle fibers. Epicondylitis, radiohumeral bursitis, and periostitis are said to be responsible for so-called "tennis elbow." Rest for the part should be secured by means of a cock-up splint for the hand and forearm and elbow, or by a sling. In the early stages, physical therapy measures should consist of conductive, then conversive heat together with superficial stroking massage. Later, deeper massage may be applied. Contractile currents, assistive and active exercise, and histamine iontophoresis are also of value.

#### INJURIES TO NECK AND SHOULDER

Injuries to the structures about the neck and shoulder can cause not only local pain but also pain referred to the entire upper extremity. "Locking" of vertebral joints may be due to damaged ligaments rather than to a slight dislocation. This condition occurs most commonly in the cervical region. The treatment consists of manipulation or traction and heat, massage and exercise (Figs. 256, 257). The Sayre head sling can be used to obtain traction and the Thomas collar to maintain it (Fig. 276).

Shoulder joint sprains may require rest in bed with traction and abduction. When the patient is ambulatory, abduction can be maintained by an aeroplane splint. Heat is applied by means of compresses, phototherapy, and conversive energies. At the end of about a week, slight passive and active motion is permitted.

Traumatic bursitis of the shoulder is discussed in the section on bursitis (page 475).

#### INJURIES TO THE FEET

Orthopedic conditions of the feet are fully discussed in the textbooks on orthopedics and in special works.

The commonly encountered foot discomfort is produced by many causes, including changes in the normal relationships of the bones and ligaments which maintain the longitudinal and transverse arches. Many of the difficulties are due to wearing improperly fitted shoes. For normal feet, shoes constructed with a flexible shank are the most satisfactory; when support is needed rigid shanks are recommended. Daily bathing of the feet in warm

Painful heels may be caused by bursitis or bony spurs. Such calcaneal spurs have been ascribed to gonorrheal and other types of infection, injuries, improperly fitted shoes, and static difficulties such as flat feet and short

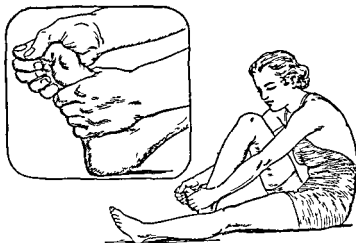

FIG 259 Self manipulation of foot. Technique and objective are essentially the same as those shown in Figure 258

plantar fascia. The treatment consists in removal of the etiological focus, rest in bed with application of an anodyne lotion, and wearing of properly fitted shoes. It may be necessary to remove the spur surgically.

#### INJURIES TO ANKLES

With severe sprains of the ankle, rest in bed is necessary. The foot should be elevated, and cold compresses applied, followed by a compression bandage. If the ligaments are badly torn immobilization or avoidance of weight-bearing for a week or ten days may be required. Less severe sprains can be treated from the start either with cold or with heat in the form of hot foot baths, hot fomentations, and diathermy followed by massage of increasing vigor. The patient may be permitted to walk, with or without the support of adhesive strapping or bandaging, depending on the extent of the damage. Mennell recommends movement and massage during the early stages. Smart suggests graduated muscle contractions achieved electrically.

#### INJURIES TO THE KNEE

Sudden rotation of the femur on a fixed tibia may rupture some of the fibers of the internal lateral ligament, with symptoms of pain, swelling, and restriction of motion of the joint. Rest, heat, particularly of the convulsive variety, and massage will usually relieve the symptoms. With displacement

water followed by dusting with powder relieves much foot discomfort. The addition of small quantities of salicylic or boric acid to the water may help further. When these measures prove inadequate, recourse can be had to hot

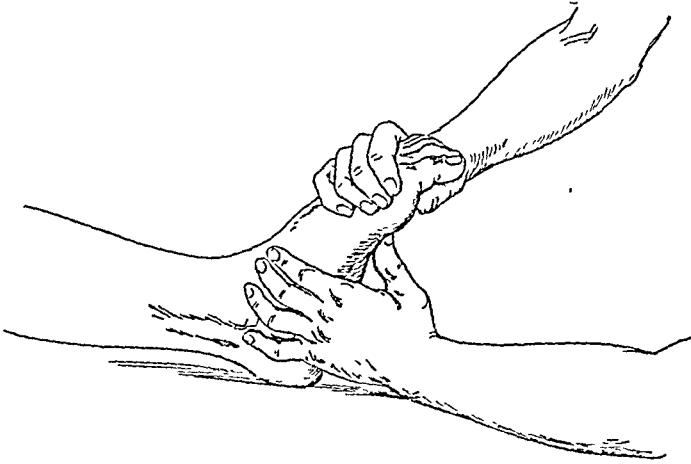

FIG. 258. Manipulation of foot. The operator steadies the foot with his left hand while his right hand pulls the distal portion of foot upward and toward the plantar surface. The operator's thumb presses inward on the region below the head of the metatarsals. The object is to stretch the extensors of the toes and to manipulate the metatarsal bones of foot.

solutions of magnesium sulphate, paraffin foot baths, or to contrast baths followed by massage.

For flat feet, treatment should be directed toward restoring the normal arch. Properly fitted shoes (with Thomas heel and metatarsal bar if necessary), hot and contrast baths, massage, exercise, and the wearing of supports help to accomplish this end. Supports are better made of felt or some resilient material than of a rigid substance such as metal. The exercises which form an important part of the regime are discussed in the chapter on exercise (page 359). Manipulation is also of value (Figs. 258, 259). When the metatarsal arch has flattened, it can be supported by felt pads or a metatarsal bar inserted into the shoes. Morton has devised a compensating insole for the shoe, which helps to support the head of a short first metatarsal bone. He believes that much foot discomfort is due to this latter condition. For acute discomfort, rest in bed, elevation of the feet, and hot compresses or soothing lotions will give relief. A felt pad arranged to diminish the weight-bearing of the three middle metatarsal heads and held in place by means of adhesive strapping, together with heat, massage, manipulation, and foot exercises, may serve to correct the difficulty.

Exercise and mechanical devices can be employed to stretch the Achilles' tendon when it has become shortened.

devices and greatly reduces the need for surgery. He considers this the best way of heeding Watson Jones's advice to "redevelop the quadriceps" after injuries to the knee joint. He points out that the Kenny method is applicable in many other injuries, for instance following reduction of fractures and dislocations, suturing of severed tendons, excision of patella or semilunar cartilage, repair of severed nerves, and in the care of burns and infections of bones and joints.

#### LOW BACK PAIN

Mock lists 155 causes of pain in the lower back. It is apparent, therefore, that in cases of low back pain, correct diagnosis is essential. History, physical findings, laboratory tests, and roentgenograms will help to determine the diagnosis. The treatment will vary with the diagnostic findings. Herniation of the nucleus pulposus or a thickened ligamentum flavum may require surgical intervention, fractures and fracture dislocations require the cooperative efforts of the surgeon and the physical therapist. A judicious mixture of immobilization, heat, massage, and exercise are the ingredients of successful treatment. A fractured vertebra calls for immobilization. Mock mentions a number of physical therapeutic axioms that should be kept in mind when treating low back pain. Too much physical therapy may aggravate a neurosis, a back brace or a sacro-iliac belt may doom the patient to invalidism. The litigation involved in compensation cases has been known to exert an adverse influence.

In the correction of defects in posture, reliance must be placed primarily on exercises. These are described in the chapter on exercises (page 341). An other helpful exercise is that described by de Forest (Figs 260 to 263). Concurrently with exercise, other measures are employed. These include heat (phototherapy, long and short wave diathermy), massage, rest in bed on a firm surface (with boards placed under the mattress), manipulation, and supporting devices.

Many cases of lower back pain result from postural abnormalities. Flattening of the longitudinal and transverse arches of the foot or shortening of the Achilles' tendon may be responsible for lower back pain. The latter condition is found in women wearing high heels with the consequent transfer of body weight to the soles of the feet and resultant changes in the lumbothoracic curves of the spine. Habitual bad posture with resultant scoliosis and lordosis may likewise produce lower back pain. Deviations from good posture may result from pathological conditions, carelessness, or positions assumed in various industries.

Diseases which affect the soft structures (muscular and fibrous) and the

or fracture of the internal semilunar cartilage, the symptoms mentioned may be more severe, and there may also be "locking" of the joint. In these cases, it may be possible to replace the cartilage by manipulation, performed under anesthesia if necessary. If the symptoms subside in response to physical measures, surgical procedures are not required; recurrence of symptoms may necessitate removal of the cartilage. Mock suggests that the patient be instructed to begin motion of the knee joint on the day of operation. Massage of the muscles of the lower leg and thigh is started early. After the tenth day, when the wound is healed, increasing amounts of heat, massage, and active exercise are given.

Synovitis of the knee joint may be caused indirectly; for example, weak feet may place an abnormal strain on the internal lateral ligaments with consequent traumatic irritations of the synovial membranes. The treatment for this condition is local. A wedge placed on the inner side of the heel may relieve the strain on the internal lateral ligament. Recurrence may be prevented by correcting the posture.

Hart has obtained excellent results in the treatment of injuries of the knee joint by means of the Kenny technique, more commonly employed in poliomyelitis (page 492). "Spasm," "mental alienation," and in-co-ordination occur in the muscles surrounding the joint and are susceptible to the Kenny method of approach. While a torn cartilage or ruptured ligament may require subsequent surgical treatment, the immediate therapeutic consideration is not surgical. Fractures of the patella, tibia, or femur may require immediate surgical care; and a hemarthrosis may necessitate aspiration. But these measures should be followed directly by application of the Kenny technique to relieve the disability and pain caused by the associated muscle damage. The muscle spasm develops in the flexor muscles of the knee immediately following injury and causes pain and flexion deformity. Treatment consists in placing the patient in bed on a firm mattress in the normal rest position, support of the flexed knee with pillow, blanket or towel, hot packs, and use of a board against which the feet are placed as soon as muscle spasm is relieved. "Mental alienation" commonly exists, particularly in the quadriceps extensor femoris. The patient is therefore taught awareness of the muscle and its normal action. Passive joint motion within a range sufficiently small to avoid muscle spasm stimulates the proprioceptive reflexes. The patient is permitted to walk (with the aid of a crutch) after he is able to perform normal rhythmic motions of his flexor and extensor muscles while in bed.

Hart has observed that this program of treatment diminishes the period of disability, eliminates the use of plaster splints and other mechanical



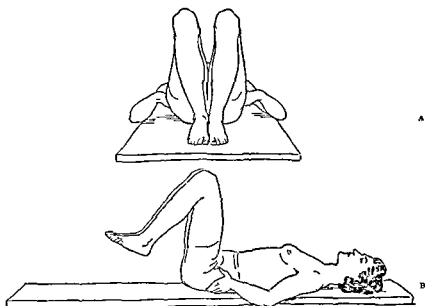

FIG 262 Exercise for the lower back *Step 3* *A* Both legs are flexed so that the inner malleoli are in contact and the knees are separated by a distance corresponding to the width of the sacrum at its base (about the width of a fist) *B* Both hips are flexed so that the thighs are in a plane vertical to the anterior superior spine of the ilium (After de Forest)

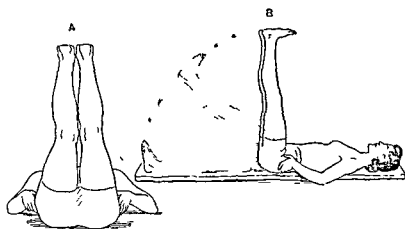

FIG 263 Exercise for the lower back *Step 4* Both knees are extended and the feet dorsiflexed. Both extremities are then lowered simultaneously while they are held fully extended with the feet maintained in dorsiflexion. This series of motions first of one leg then of the other, then of the two together constitute one exercise. At the start this exercise should be repeated three times at each session. The number of times is gradually increased until the subject performs twenty such exercises every session. The number of sessions should be five per day—one in the morning one at night and three during the course of the day (After de Forest)

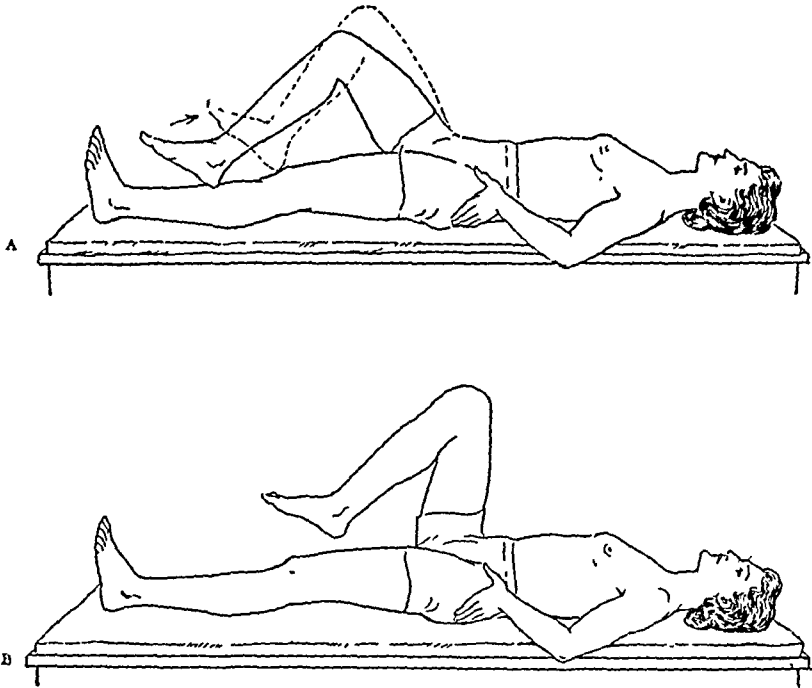

FIG. 260. Exercise for the lower back. *Step 1:* *A.* The patient lies supine with his thumbs placed on the anterior-superior spine of the ilia. The hip and knee are flexed so that the heel is placed at about the mid-portion of the tibia of the other leg. This is the starting position. Flexion is continued until the heel touches the patella. *B.* The hip continues to be flexed until the tuberosity of the tibia is directly over the anterior-superior spine of the ilium. (After de Forest.)

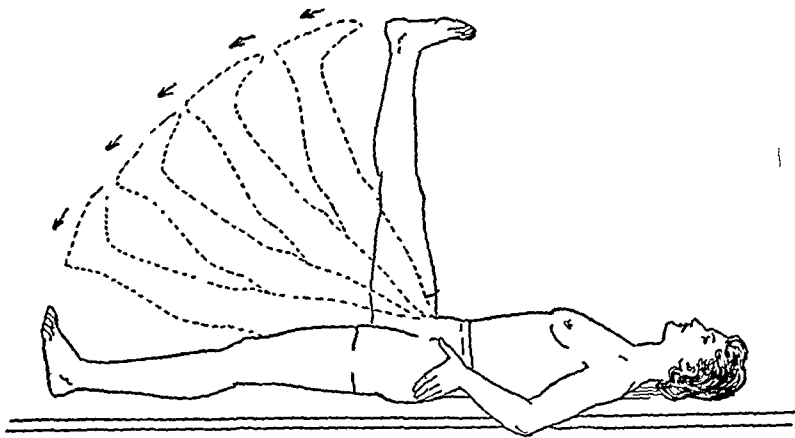

FIG. 261. Exercise for the lower back. *Step 2:* The knee is extended and the foot dorsiflexed. The leg is then lowered in full extension while the foot continues to be held in dorsiflexion. After these four series of movements have been completed, the other lower extremity is exercised in the same manner. (After de Forest.)

same purpose Many patients find that they can sleep better if the bed is not too soft, wooden boards placed between the mattress and the bed spring provide a firm surface A specially constructed bed with its hard surface

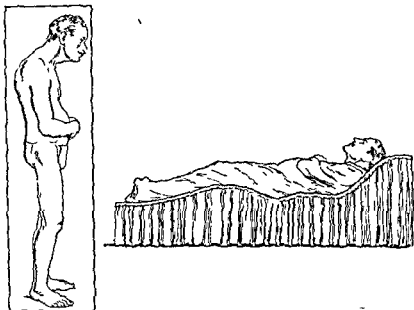

FIG 264 Patient with marked deformity of spine due to ankylosing arthritis lying on couch constructed to conform with curves of back

curved to fit the contours of the back has given dramatic relief to some patients unable to sleep satisfactorily because of pain in the back The support given by this device to the entire back may have permitted muscle relaxation (Fig 264) After a pattern has been made of the outline of the back, allowances are made for the therapeutic alterations of the lumbosacral curves and for flexion at the hip and knee This device has been developed by Dr A W Schenker

Sacro-iliac and lumbosacral strains, both acute and chronic, and myositis and fibrositis can be improved by manipulative therapy Before attempting manipulation one should make certain that conditions which will be aggravated by such manipulative procedures do not exist Such conditions are tuberculous and syphilitic inflammations, acute arthritis, compression fractures of the vertebrae, and malignancy Preparatory to manipulative procedures the muscles should be relaxed by applying first heat and then massage The massage should include the gluteal muscles as well as the muscles of the back

Jostes and Roche described the following manipulative maneuvers for the lower back

bones and joints frequently cause pain in the lower back. The muscular and fibrous tissue may be injured directly by trauma; or, more commonly, indirectly, as a result of unnatural tension due to bad posture or to inflammatory conditions such as myositis and fibrositis. Damage to the bony skeleton which can produce lower back pain may be caused by fractures and dislocations of vertebrae and intravertebral discs. Inflammation of the joints may occur between the fifth lumbar vertebra and the sacrum, and between the sacrum and ilium.

Faulty posture may coexist with a contracted fascia lata. Ober has found that overcoming contraction of the fascia lata permits improvement of posture with consequent relief of lower back pain. The following stretching exercise is advised for this purpose. The patient stands near a bed or near a table or wall which will serve as support. With both feet held firmly on the ground, he leans toward the uninvolved side, stretching the contracted fascia lata as far as he can. The support of his arm on the side toward which he is leaning prevents him from falling (Fig. 216). This exercise should be done about ten times on three occasions during the day. It should be performed slowly, the stretched position being held for about ten seconds. If exercises prove inadequate, operative procedure to cut the fascia lata must be resorted to.

Myositis and myofascitis and fibrositis are terms employed to designate inflammation in the soft tissues. These inflammatory conditions give rise to pain and stiffness. The sufferer limits his motion to avoid pain. Palpation reveals muscle spasm, and areas of tenderness which may feel nodular. Treatment consists in the use of heat, both conductive and convulsive, followed by firm massage. Muscle movement produced by electric currents or by manipulation may give additional relief. The areas between the lumbar vertebrae, between the fifth lumbar and the sacrum, between the sacrum and the coccyx, and between the ilium and the sacrum on either side, may be the seat of pathological changes which cause pain and tenderness with or without sciatic radiation. The exact site of the inflammation may be determined by the areas of tenderness and the evaluation of various motions. Heat, manipulation, exercise, and massage are used in an effort to counteract the muscle spasm and to diminish the pain. The most effective heating is carried out by means of high frequency currents.

The chronic sufferer from lower back pain should rely on exercise, and, if necessary, the wearing of a supporting belt to prevent recurrence of pain. During the acute stage, some supporting device such as a belt or brace will probably be necessary. Adhesive strapping is a temporary measure for the

of the upper shoulder. Simultaneously the shoulder is pushed backward and the buttock forward and upward, so that the hand on the hip travels in a spiral or corkscrew like curve. This maneuver causes lordosis of the spine, tilting for-

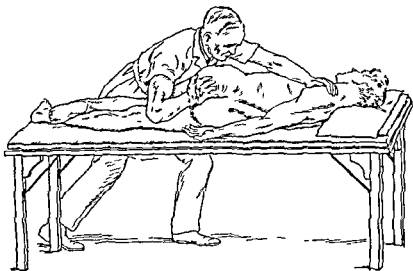

FIG. 265 Manipulation for painful sacro iliac (Travell maneuver)

ward of the upper part of the sacrum and twisting of the body, resulting in a forward rotation of the sacrum on the ilium on which the patient is lying and which is immobilized by the weight of the body.

The force is applied smoothly and steadily without jerks to effect gradual stretching, and when maximum rotation of the trunk is obtained, a quick final thrust is made. Different amounts of force are required for reduction in different cases, but a large reserve of strength is needed in order to perform the manipulation smoothly and to sustain the effort for sufficient time to overcome muscular resistance. Ordinarily, the duration of the maneuver is from fifteen to thirty seconds, but longer periods are at times necessary.

Travell recommends that an effort be made to secure muscular relaxation before attempting to maneuver. This may be achieved by rest in the recumbent position for a period of twenty to thirty minutes during which time heat is applied to the back by means of a convective or a conductive heating technique or by the static surge. For ambulatory treatments they recommend a tight fitting belt to be worn between periods of manipulation. At night, the patient should lie on a mattress under which boards are placed. A small pillow under the lumbar region may give additional comfort.

#### TENOSYNOVITIS

Inflammation of tendon sheaths may be caused by trauma, infections, or metabolic diseases. Traumatic tenosynovitis may follow a severe injury or the frequent repetition of a mild one, such as may occur in typewriting,

1. The patient is placed on his right side. The thigh, knee, and hip are fully extended. The left knee and hip are flexed. The right hand is placed over the anterior aspect of the shoulder. The left hand grasps the ilium in the region of the anterior-superior spine. Simultaneously, pressure is exerted downward and backward on the left shoulder and forward and downward on the left hip. The pressure should be applied suddenly in both these regions so as to produce a rotary movement of the torso.

2. The hands of the operator are so placed as to reverse this motion, the pressure in the region of the hip being exerted backward while the shoulder region is pushed forward.

3, 4. The patient is turned on the left side and the same procedures repeated.

5. The patient lies prone. The right hand of the operator is placed over the left gluteus maximus while the left hand grasps the left thigh and hyperextends it.

6. The preceding maneuver is repeated on the other leg.

7. With the patient lying prone, the operator stands astride him, grasps the pelvis in the region of the anterior-superior spine and lifts it up. The pelvis is rotated first to one side and then to the other. With a heavy patient, this maneuver can be carried out by means of a belt which is placed over the region of the pelvis and held by two operators, one on either side.

8. The patient lies in the prone position. The operator grasps the patient's feet and hyperextends the legs on the back. With this hyperextension maintained, one thigh and then the other is dropped so as to cause a rotation of the pelvis.

9. The hip is flexed with the knees fully extended.

10. The operator grasps the patient's legs in one hand, while preventing his feet from moving with the other hand. The patient's hips are flexed so that the thighs approach the abdomen. The operator then lifts the patient's pelvis clearly off the floor and rotates it laterally on the trunk, first in one and then in the other direction.

11. With the patient in the sitting position, the operator places one knee against the spine and presses forward with it while pulling back on the patient's shoulder.

12. The patient's leg on the involved side is allowed to hang over the edge of the table as the patient lies on his back.

The Travells have described a useful manipulative procedure, which they call the "corkscrew" technique (Fig. 265):

The patient lies on the affected side, preferably on a hard table. The leg beneath is hyperextended at the hip with the knee straight; the other leg is allowed to fall into a natural position with the knee slightly bent and the foot hooked loosely over the lower ankle; the arm beneath is drawn forward out of the way at a right angle with the body, and the other arm hangs loosely behind the back.

The operator stands in front of the patient. One hand slightly overlaps the sacrum and grasps the upper ischial tuberosity; the other hand grasps the front

When contractures have developed, they should be treated with heat, massage, active, passive and assistive exercise, whirlpool baths, continuous traction, negative galvanism, and electric current causing vigorous contractions

In administration of negative galvanism, absorbent cotton or a cloth soaked in salt solution is placed over the scar area and connected to the negative pole by a metal contact. The active electrode is a moist pad placed over the scar area and connected to the negative pole by a metal contact. The dispersive electrode is a moist pad placed on another part and connected to the positive pole. Depending on the size of the active electrode, one or more milliamperes are used. The duration of the treatment varies from fifteen minutes to one hour. The softening action exerted by this current can be explained on the basis of electrophoresis (electro-osmosis)

If persisted in, these measures produce marked improvement. The conditions which are most stubborn in their response are Volkmann's ischemic contracture and Dupuytren's contracture. If improvement occurs at all, it is usually extremely slow. Preventive measures in Volkmann's contracture consist in avoiding bandages and circular casts which are too tight. Dupuytren's contracture may develop from occupational activities which cause frequent blows to the palm of the hand, for example, electrical cutting machines used in the garment trades and pneumatic drills. Surgical intervention is advised when physical therapeutic measures prove of no avail. It should be followed by the physical measures advised for the treatment of contractures

### BURSITIS

Subacromial bursitis is a frequent cause of pain in the region of the shoulder. It should be differentiated from a tear or inflammation of the supraspinatus tendon, tenosynovitis of the long head of the biceps, periostitis of the humerus, brachial neuritis, and inflammations of the coraco acromial, subscapular, and infraspinatus bursae. Acute inflammations of the subacromial and subdeltoid bursae require rest and applications of cold in the initial stages. Acute inflammations may be so painful that they must be treated by immobilization of the shoulder in abduction and external rotation, sedatives, and, at times, aspiration of the fluid and injection of anesthetic solutions into the area about the shoulder joint. As a rule, application of cold compresses for twenty minutes every hour relieves the acute pain in from twenty four to forty-eight hours. After the acute stage is passed, heat is applied from a carbon or tungsten filament lamp or by means of

piano-playing, golfing, rowing, and tennis. The inflammation responds to physical therapeutic procedures; hot baths, hot packs, and fomentations, whirlpool baths, diathermy and short wave currents and electrotherapy in the form of the faradic and sinusoidal currents to produce muscle contractions, massage, muscle training and exercise are all useful. The character of the massage should be governed by the stage of the inflammation; if acute, only superficial stroking will be tolerated; when it subsides deep stroking and friction can be employed. In the latter stages of tenosynovitis in the region of the wrist a leather wristlet may increase the patient's comfort.

If a tendon is ruptured, it must be sutured and the part splinted as early as possible. Heat, massage, and gentle active motion should follow. Henson states that ganglion formation and locking of tendon motion sometimes follows injuries in the tendon or in areas adjacent to it. A ganglion can be ruptured by a blow or pressure, and this may prove to be adequate treatment. If a ganglion recurs, the tendon can be aspirated with a large bore needle and diathermy applied to the area. If the ganglion persists, it may be incised or injected with a sclerosing solution such as sodium morrhuate. Pyogenic tenosynovitis requires surgical incision. Heat, massage, and passive motion should be applied early in an effort to prevent adhesions. In gonorrhoeal, syphilitic, and tuberculous tenosynovitis, treatment is that of the systemic condition plus the care of the local manifestation by rest and heat.

In rheumatic and gouty inflammations of tendon sheaths, systemic treatment is aided by splinting and phototherapy of the injured part in the acute stage, followed by more intense heat, passive motion, then active motion in the latter stages. Rheumatic inflammation of tendons occurs in peri-arthritis of the shoulder, radial epicondylitis, femoral condylitis, lumbago, and in the Achilles tendon and in torticollis. According to Mock, tenosynovitis of the long head of the biceps as it passes in the groove of the humeral head beneath the deltoid requires that the arm be supported in the position that will provide relaxation to the biceps. Very light massage, sinusoidal stimulation, and gradually increasing passive motion should be applied.

#### CONTRACTURES

Contractures may result from atrophic changes in muscles and tendons. The best method of treatment is preventive. Cock-up splints for the hand, splints to counteract development of foot drop, encouragement of motion in chronically ill patients who tend to assume positions leading to flexion contractures of the knee and other joints, early use of physical therapy in the care of fractures and similar measures should be instituted.



rest in bed, cold or mild heating (by means of phototherapy), followed by converse heat applications, massage, and galvanism with or without histamine iontophoresis. In traumatic bursitis in the region about the knee, cessation of the irritation followed by converse heating and massage will usually bring about rapid improvement. Inflammation of the small bursae of the feet produced by pressure from shoes is helped by removal of the cause, by rest, and by heat applied by foot baths. An inflamed bursa which develops over a bunion may require surgery. Inflammations can also develop in the ischial, iliopectineal, iliopsoas, and great trochanteric bursae. Bursitis in the region of the great trochanter may resemble osteomyelitis or tuberculosis of the hip. Iliopectineal and iliopsoas bursitis must be differentiated from psoas abscess, femoral hernia, and coxitis.

#### FRACTURES

In spite of all that has been said concerning the advantage of early application of physical therapy in the treatment of fractures, comparatively little attention is given to the possibility of diminishing the period of disfunction by this means. The physician or surgeon is likely to focus his attention almost exclusively on the reduction of the fracture so as to restore the bone ends to their normal anatomical relationships and to maintain the fragments in their restored position. While these are, of course, the two important considerations in the treatment of fractured bones, nevertheless they are secondary to the major objective, namely restoration of normal function. Even when reduction and fixation have been properly carried out, prolonged periods of immobilization may result in a marked limitation of the use of an extremity. The serious injury to the soft tissue that occurs in conjunction with a fracture should not be neglected. When properly applied, physical therapy can effect rapid improvement in function without danger of displacement of bony fragments. The pathological and physiological bases for early application of physical therapy has been pointed out (page 478). The long period of lymphatic and venous stasis results in an overgrowth of connective tissue. Such stasis is encouraged not only by pressure of extravasated blood and lymph, but also by lack of muscular contraction. As Wilson points out, "The fixation of muscles and joints not only interferes with the re-establishment of circulation and the absorption of exudates, but it also favors the extensive development of scar tissue and adherence of the muscles to each other and to the bone." Lack of muscle action causes atrophic changes within the structures and also thickening of joint capsules.

The development of improved methods of fixation permits early applica-

hot compresses. During the subacute stage, as well as later, positive galvanism and histamine iontophoresis are of value. With the passing of the subacute stage, subsidence of the condition can be accelerated by converse heating followed by massage and exercise. Converse heating can be applied in several ways. For the short wave current, a pancake coil is placed in cup-like fashion over the region of the shoulder. Air-spaced or flexible condenser electrodes may be put anteroposteriorly, or one semi-cuff shaped electrode may be arranged over the base of the neck while the other electrode is placed on the outer aspect of the upper arm in the region of the deltoid muscle. These electrodes may also be placed so that one covers the shoulder, while the other larger electrode is placed on the outer aspect of the chest on the other side. The duration of the treatment is fifteen to thirty minutes.

Diathermy electrodes may be disposed in a manner similar to the condenser electrodes; or the grounded "autocondensation technique" may be used. With the latter procedure the patient lies or sits on an autocondensation pad and holds a metal bar attached to the other terminal of the diathermy machine. After the current has been turned on, the operator places one or two fingers on the skin covering the bursae. This current is kept on for ten to fifteen minutes. The more usual diathermy treatments are applied for periods varying from fifteen to thirty minutes.

In chronic bursitis, as well as in periarthritides of the shoulder joint, motion may be limited; abduction and external and internal rotation may be restricted. To increase the range of motion, passive, assistive and active exercises are used in conjunction with heating measures, massage, and currents causing vigorous contractions of muscles. Exercise under water may allow increased excursions of joint motion. Swimming is a good sport for these patients. Gymnastic devices such as the shoulder wheel, overhead pulleys and overhead bars encourage abduction. In the home, the door frame may take the place of the overhead bar and the wall affords a place for finger-crawling exercise. A mark on a piece of paper hung on the wall will serve to indicate the highest point reached. In successive attempts, the patient should try to exceed the previously gained height. To extend the range of motion it may become necessary to force motion under anesthesia. The extremity may then be held in abduction and external rotation with light traction. The early use of passive followed by assistive and active exercise is necessary to prevent the reformation of adhesions. Physical therapy alone will resolve calcific deposits that have been demonstrated by x-ray.

Like localized trauma to other soft tissues, traumatic bursitis usually responds relatively quickly to physical procedures. The treatment consists of

In the early stages heat is most conveniently applied by means of lamps or hot compresses. Such superficial heating may be better than the deeper heating of the converse currents, because if the latter produces too active an arterial flow the interference with the lymphatic and venous drainage in the structures beneath the skin may further increase the circulatory embarrassment. Superficial heating action has a pain relieving value, it reflexly diminishes pain and muscle spasm. Deep stroking massage and kneading are employed later to counteract stasis.

The muscle and joint trophism may be further stimulated by exercise. This causes an acceleration of circulation and prevents adhesions. At first, exercise should be passive, with the patient's muscles relaxed. The development of pain and muscle spasm are indicative of too vigorous an application of massage or exercise. As callus formation becomes more definite, assistive exercises replace the passive. After firm union has occurred, exercise should become active. The various motions which may be employed are described in the chapter on exercise (page 338). The voluntary exercise derived from occupational therapy is usually more interesting and therefore more valuable than any set forms of exercise.

Lindsay and Brown state that early mobilization is indicated in those cases in which there is no gross deformity or in which gross deformity is not likely to result from the forces employed in obtaining motion. Incomplete and subperiosteal fractures of the shaft and complete and incomplete fractures in and about the joints are most likely to fall into this classification. In addition, there are cases in which gross deformity or displacement may be corrected and the position maintained with or without internal fixation. Examples of fractures in which early mobilization may follow reduction and internal fixation are those of the patella and the olecranon.

Wilson calls attention to the fact that delayed union or non union is more likely to occur in the shafts of the long bones than in fractures through cancellous bones, and especially in fractures of the scaphoid, neck of the femur, and in both bones of the forearm at the middle and upper third. He cautions that immobilization of these regions should therefore be as complete as possible, even though it be at the expense of functional improvement.

Physical therapy is contraindicated when there is any danger of displacing the bone fragments. Thus, early treatment must be given very cautiously. In children, fractures usually heal rapidly and thoroughly so that indications for physical therapy are not so great as in the treatment of fractures occurring in later years. Physical therapy procedures can be applied to the point of pain tolerance if the reaction disappears within an hour or two, if it per-

tion of physical measures. These relatively recent techniques include fixation at bone operation, direct bone traction by means of Kirschner wires, pins and tongs, and traction suspension by means of the Thomas splint. Plaster-of-Paris casts can be bivalved to allow physical therapeutic procedures to be carried out. Joints whose movements do not interfere with the alignment of the bone ends should not be immobilized; for example, in fractures of the radius and ulna, finger movement should be permitted. So also with the toes in fractures of the leg. The time at which mobilization of fractured extremities can be begun varies with the location of the fracture.

The physical therapeutic measures employed for fractures are heat, massage, and exercise. Lucas-Championnière first pointed out the advantages to be derived from the early use of massage and mobilization in the treatment of fractures. Many physicians, since, have added their testimony to the value of his suggestion. They have shown that massage (which can be applied before as well as directly after the reduction of a fracture) causes diminution in pain and discomfort and improvement in circulation. Repair is thus hastened, joint motion increased, and muscle atrophy diminished. These effects of massage are due to a reflex reaction inasmuch as superficial stroking form of massage is used.

Watson, in advocating the early use of massage and mobilization as a result of his experiences said: "Organization occurs during the first nine to ten days, hence it is during this crucial period that the local drainage apparatus, the circulatory and lymphatic systems, already reduced in efficiency by the injury received, should be aided in their work of debris removal. Massage rapidly removes these effusions and extravasations by restoring the local lymphatic and circulatory drainage to its former efficiency." During the period of the first two weeks physical therapy should be employed in order to obtain the removal of hemorrhage and exudates. Inasmuch as this is the time in which there is the greatest danger of displacing bone fragments, Wilson suggests that the treatment should be applied by the physician or under his direct supervision. After the initial period, the purpose of physical therapy is to prevent adhesions and atrophic changes in muscles and joints.

Studies conducted on the breaking strength of healing fractures in rats show no measurable strength before the sixth day. From the sixth to the twenty-first day the size and the strength of the callus increase; from the twenty-first to the thirtieth day the strength and the size decrease. After the thirtieth day the callus continues to decrease in size and the strength gradually increases again until about the forty-eighth day it equals that of the unbroken portion of the shaft.

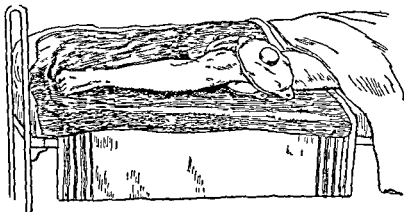

FIG 266 Refrigeration technique for mid leg amputation *Step 1* Three ice bags are placed proximal to the knee. They are permitted to remain for a period of about one half hour. Their purpose is to diminish the sensitivity of the skin with which they are in contact and to cause the tissue to tolerate constriction (After Allen and Crossman)

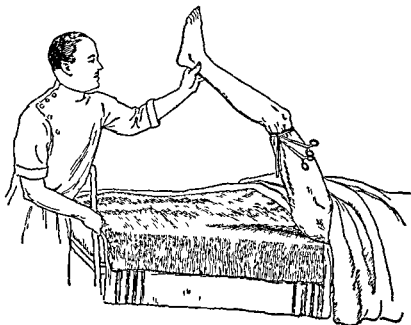

FIG 267 Refrigeration technique for mid leg amputation *Step 2* After one half hour the leg is elevated at an angle of 70 to 80 degrees from the horizontal. It is held in this position for fifteen minutes. This is done to drain fluid from the extremity so that when the tourniquet is applied the limb will be as avascular as possible. At the end of this period of leg elevation the tourniquet is applied proximal to the knee. The tourniquet is made of firm but yielding rubber tubing. It is applied tightly to shut off arterial as well as venous flow. Two turns of the rubber tourniquet are placed so that they appear as relatively flat bands superimposed on each other. The loose ends are held fast by means of two Kocher clamps. This method of tourniquet application presents a relatively narrow surface to the constricted tissue. The leg assumes a cadaverous appearance. It should not be cyanotic. (After Allen and Crossman)

sists, together with muscle spasm, for twenty-four hours or more, the treatment is too severe.

When patients present themselves for treatment because of pain, swelling, and limitation of motion several weeks or months after the occurrence of a fracture, a much longer period of time is required to effect improvement. This can usually be brought about through the persistent use of converseive heating, massage, and active and assistive exercise.

### OSTEOMYELITIS

Acute osteomyelitis is best treated with the sulfonamide drugs and incision for purposes of drainage. In chronic osteomyelitis with drainage, converseive heat is a valuable therapeutic adjunct. If a sequestrum is responsible for the continuance of a chronic sinus, it must be removed before the wound will heal. In cases in which it is possible, self-extrusion of a sequestrum may be hastened by heat applications. Ultraviolet radiation administered through quartz rods inserted into the sinuses leading to the bone, stimulates growth of granulation tissue.

### TUBERCULOSIS OF BONES AND JOINTS

Tuberculosis of bones and joints must be considered as a systemic disease with local manifestations. Rest, high caloric diet, fresh air, and heliotherapy are all needed to improve the systemic recuperative powers. Orthopedic measures must be adopted for the prevention and correction of deformities. Beneficial physical measures are: ultraviolet radiation; baths, particularly sea-bathing; exercise; and occupational therapy. Local applications of ultraviolet radiation to open wounds and sinuses are helpful. Satisfactory treatment may require a period of time varying from nine months to three years.

### AMPUTATIONS

Allen and Crossman described a useful method for anesthetization of the leg in preparation for amputation. The technique of refrigeration which they employ for this purpose is illustrated in Figures 266, 267, 268, 269. An electrically operated refrigerator machine is also available for this purpose. Yount summarized the place of physical therapy in the after-care of amputations. He stated that physical therapy should be started within a few days following amputation. The chief measures are massage, motion, hardening of the stump, splinting, and the wearing of prosthesis. Light stroking massage should be started on the stump just above the protective dressing

forcibly against the bottom of a chair or the surface of a table The whirl pool bath is a useful measure in the after-care of amputations

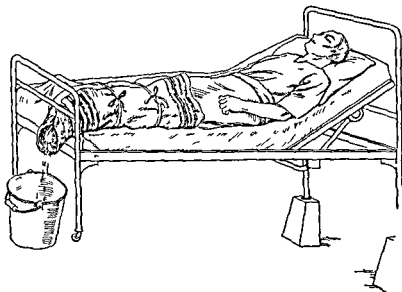

FIG 269 Refrigeration technique for mid leg amputation *Step 4* After the leg has been completely surrounded with ice, the edges of the rubber cloth are brought together to form in effect a loose boot The section of the blanket underneath the rubberized cloth is wrapped around it Both of these layers are held in place by two bandages tied in bowknots in order that they may be opened readily when it becomes necessary to replace the ice that has melted The ice is kept in place for about two and one half hours It is not removed until immediately preceding the operation

For amputation of the foot, the tourniquet is placed immediately below the knee The leg and foot can be immersed in a bucket of ice and water so that this chilling medium extends to just above the tourniquet For amputation at the mid thigh the level at which the tourniquet is placed and that to which the ice is applied are both extended An electric refrigeration unit has been constructed which facilitates the application of cold After amputation the air surrounding the stump is held at a reduced temperature by means of a refrigerating hood (After Allen and Crossman)

#### REFERENCES

- BOYD, D, OSBORNE, S L, and MARKSON, D E Mecholyt ionization in arthritis  
*Arch Phys Therapy*, 20 406-410, 1939
- BRADFORD, S S Exercise in treatment of arthritis *M Rec*, 148 74-76, 1938
- COPELAND, W S C, and ACKERMAN, W L Fibrositis of the back *Quart J Med* 13 37, 1944
- DESCOEUDRES, P, and WACHER, TH Bee venom by ionization *Schweiz med Wchenschr*, 68 179-182, 1938
- FISHER, A G T Treatment by Manipulation New York, Hoeber, 1939
- FRITZ, H Spondylitis Deformans *Therap & Gegenw* 78 457-462, 1937
- GORDON, R G Psychologic factor in chronic rheumatism *Brit M J*, 1 1165-1169, 1939

and continued up the limb. As soon as the incision is healed, light stroking and kneading massage should be started over the end of the stump. The purpose is to relieve the sensitiveness and accustom the patient to touching

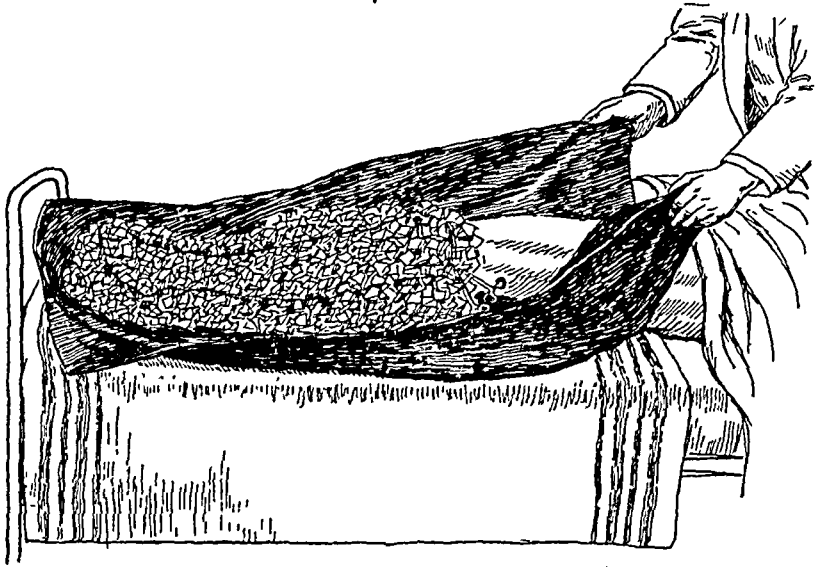

FIG. 268. Refrigeration technique for mid-leg amputation. *Step 3.* The leg is now completely surrounded with ice chopped into small pieces. About two inches of surface proximal to the tourniquet is included in the area exposed to the ice. A rubber sheet is disposed in trough-like shape to hold the ice and to permit the water, which accumulates as the ice melts, to drip into a pail placed on the floor at the foot end of the bed. Beneath the rubberized cloth, a section of blanket whose edges extend beyond that of the rubber cloth is placed. (After Allen and Crossman)

and handling the stump, to prevent adhesions and keep the end of the stump pliable, and to prepare the stump for complete or partial end-bearing. In cases in which there are adherent scar contractures and impaired function in adjacent joints, massage should be continued even after the patient is discharged from the hospital.

Passive and active motion of the stump should be started within a few days after amputation. At first, the surgeon must gently move the joint, but within a few days, the patient must be taught and stimulated to move the extremity and to flex and extend the adjacent joints several times a day. The massage to accustom the patient to end-bearing and hardening can likewise start within a few days. As soon as active motion has developed, the patient should be taught to tap the stump lightly on a pillow. Later, when the wound is healed, this tapping is continued with the stump end exposed. The hardness of the surface being tapped is gradually increased until the patient, within two or three weeks, is stroking his stump rather



- HART, V. L. The Kenny principles and injuries of the knee joint. *J.A.M.A.*, 120 : 900-902, 1942.
- HARTUNG, E. F. Postural defects in relation to arthritis. *Arch. Phys. Therapy*, 18 : 626-629, 1937.
- HARTUNG, E. F. Personal communication. New York, April 11, 1942.
- JOSTES, F. A., and ROCHE, M. B. Manipulative therapy for back conditions. In Principles and Practice of Physical Therapy. Hagerstown, Maryland, Prior, 1932, Vol. III, Chap. 23.
- KRAUS, H. Treatment of charley horse. *Wien. klin. Wchnschr.*, 50 : 1356-1357, 1937.
- LANGE, M. Die Muskelhaerten. Munich, J. F. Lehmann, 1931.
- LINDSAY, M. K., and BROWN, C. M. Relaxed motion in the early mobilization of fractures and dislocations. In Principles and Practice of Physical Therapy. Hagerstown, Maryland, Prior, 1932, Vol. III, Chap. 16.
- LUCAS-CHAMPIONNIERE, J. Le Massage et la Mobilization dans le Traitement des Fractures. Paris, A. Cocoz, 1889.
- MENNEL, J. Massage in the treatment of recent injuries. In Principles and Practice of Physical Therapy. Hagerstown, Maryland, Prior, 1932, Vol. III, Chap. 13.
- MOCK, H. E. Physical therapy in joint surgery. In Principles and Practice of Physical Therapy. Hagerstown, Maryland, Prior, 1932, Vol. II, Chap. 2.
- OBER, F. Relation of fascia lata to conditions in the lower part of the back. *J.A.M.A.*, 109 : 554-558, 1937.
- OBER, F. Physical therapy in infantile paralysis. *J.A.M.A.*, 110 : 45-46, 1938.
- PENNINGTON, D. Contribution of the hydrotherapist to the rheumatic problem. *Brit. J. Rheumat.*, 2 : 3-13, 1939.
- TRAVELL, W., and TRAVELL, J. Technic for reduction and ambulatory treatment of sacroiliac displacement. *Arch. Phys. Therapy*, 23 : 222, 1942.
- TRAVELL, W., and TRAVELL, J. Personal communication. June 10, 1942.
- VRTIAK, E. G., and KOBAK, D. Combined Fango mud therapy. *Arch. Phys. Therapy*, 20 : 487-493, 1939.
- WATSON, P. The treatment of simple fractures by massage and movement. *Edinburgh M. J.*, 9 : 319, 1912.
- WILLIAMS, H. L., and ELKINS, E. C. Myalgia of the head. *Arch. Phys. Therapy*, 23 : 14-22, 1942.
- WILSON, P. D. Physical therapy in the treatment of fractures. In Principles and Practice of Physical Therapy. Hagerstown, Maryland, Prior, 1932, Vol. II, Chap. 5.
- WOODMANSEY, A., COLLINS, D. H., and ERNST, M. M. Vascular reactions to the contrast bath in health and in rheumatoid arthritis. *Lancet*, 2 : 1350-1353, 1938.
- YOUNT, C. C. Physical therapy in amputations. In Principles and Practice of Physical Therapy. Hagerstown, Maryland, Prior, 1932, Vol. II, Chap. 13.

## NEUROLOGICAL DISEASES

## HEMIPLEGIA

**P**ARALYSIS MAY BE A SEQUELA OF VARIOUS INJURIES TO the central nervous system. One of the commonest of these is hemiplegia following a vascular lesion such as hemorrhage, thrombosis, or embolism. If the patient survives, spontaneous improvement usually occurs, first in the lower extremity, then in the face, and finally in the upper extremity. In the early stages, the first consideration is to prevent extension of the lesion. Rest is therefore essential. Next, trophism of muscles and joints must be maintained so that these structures may be able to function when, with regression of the cerebral changes, voluntary impulse is restored. The extremities should be placed in the position which exerts the least tension on the weakest muscle groups. The feet should be held at right angles to the leg by means of pillows or sandbags in order to counteract a tendency to foot drop. The bed clothes should be held away from the toes by a cradle or some other device. Flexion contractures of the wrist may be prevented by holding the hand in dorsiflexion with a cock up splint. Faulty positions can be corrected with pillows, sandbags, or light splints. It has been suggested that the affected limbs be splinted in such a position that there is some deviation from the midposition of the joint toward the outer group of muscles, for example, to obtain abduction of the shoulder, the elbow is splinted in extension or slight flexion at midposition between pronation and supination. Overstretching of paralyzed muscles can be minimized by frequent changes in position.

As soon as progression of the cerebral injury appears to be halted, the affected limbs should be massaged with gentle superficial stroking. Gentle, passive motion of all joints should be repeated several times a day, and gradually increased in vigor. Passive movement helps to maintain muscles and joints in good condition. Voluntary movements should be encouraged, and the arc of joint movement completed passively if necessary. The patient can perform some of these passive movements with the normal hand. Mild

- HART, V. L. The Kenny principles and injuries of the knee joint. *J.A.M.A.*, 120 : 900-902, 1942.
- HARTUNG, E. F. Postural defects in relation to arthritis. *Arch. Phys. Therapy*, 18 : 626-629, 1937.
- HARTUNG, E. F. Personal communication. New York, April 11, 1942.
- JOSTES, F. A., and ROCHE, M. B. Manipulative therapy for back conditions. In Principles and Practice of Physical Therapy. Hagerstown, Maryland, Prior, 1932, Vol. III, Chap. 23.
- KRAUS, H. Treatment of charley horse. *Wien. klin. Wchnschr.*, 50 : 1356-1357, 1937.
- LANGE, M. Die Muskelhaerten. Munich, J. F. Lehmann, 1931.
- LINDSAY, M. K., and BROWN, C. M. Relaxed motion in the early mobilization of fractures and dislocations. In Principles and Practice of Physical Therapy. Hagerstown, Maryland, Prior, 1932, Vol. III, Chap. 16.
- LUCAS-CHAMPIONNIERE, J. Le Massage et la Mobilization dans le Traitement des Fractures. Paris, A. Cocoz, 1889.
- MENNELL, J. Massage in the treatment of recent injuries. In Principles and Practice of Physical Therapy. Hagerstown, Maryland, Prior, 1932, Vol. III, Chap. 13.
- MOCK, H. E. Physical therapy in joint surgery. In Principles and Practice of Physical Therapy. Hagerstown, Maryland, Prior, 1932, Vol. II, Chap. 2.
- OBER, F. Relation of fascia lata to conditions in the lower part of the back. *J.A.M.A.*, 109 : 554-558, 1937.
- OBER, F. Physical therapy in infantile paralysis. *J.A.M.A.*, 110 : 45-46, 1938.
- PENNINGTON, D. Contribution of the hydrotherapist to the rheumatic problem. *Brit. J. Rheumat.*, 2 : 3-13, 1939.
- TRAVELL, W., and TRAVELL, J. Technic for reduction and ambulatory treatment of sacroiliac displacement. *Arch. Phys. Therapy*, 23 : 222, 1942.
- TRAVELL, W., and TRAVELL, J. Personal communication. June 10, 1942.
- VRTIAK, E. G., and KOBAK, D. Combined Fango mud therapy. *Arch. Phys. Therapy*, 20 : 487-493, 1939.
- WATSON, P. The treatment of simple fractures by massage and movement. *Edinburgh M. J.*, 9 : 319, 1912.
- WILLIAMS, H. L., and ELKINS, E. C. Myalgia of the head. *Arch. Phys. Therapy*, 23 : 14-22, 1942.
- WILSON, P. D. Physical therapy in the treatment of fractures. In Principles and Practice of Physical Therapy. Hagerstown, Maryland, Prior, 1932, Vol. II, Chap. 5.
- WOODMANSEY, A., COLLINS, D. H., and ERNST, M. M. Vascular reactions to the contrast bath in health and in rheumatoid arthritis. *Lancet*, 2 : 1350-1353, 1938.
- YOUNT, C. C. Physical therapy in amputations. In Principles and Practice of Physical Therapy. Hagerstown, Maryland, Prior, 1932, Vol. II, Chap. 13.

side and connected by means of a small metal plate to the positive pole. The negative electrode is placed at the back of the neck. A current of 2 to 5 milliamperes is permitted to flow for one-half hour. A series of fifteen applications is made at three week intervals, the first six treatments are administered daily, the remaining nine every other day. Cloetta and Waser demonstrated that the temperature of the tissue inside of the cranium of rabbits can be elevated by long wave diathermy applied to the head. The active hyperemia so produced may speed absorption of extravasated blood and lymph. Because of the danger of increasing the hemorrhage, high frequency currents, either long or short wave diathermy should not be used until a period of several weeks from the time of the initial attack has elapsed. It is difficult to evaluate the results of any therapy in hemiplegia because of the spontaneous improvement that takes place. However, it is our impression that converse heating by high frequency currents is of value in some cases of hemiplegia. In this treatment the electrodes are placed on the forehead and on the occiput and upper neck.

#### INTRACRANIAL TUMORS

Following removal of intracranial tumors, physical therapy is a useful means of hastening restoration of returning function. The paralyzed limbs may be heated by hot compresses, phototherapy, and whirlpool baths. Caution should be observed in applying heat, especially when there is loss of thermal sensation. If the paralysis is of the spastic variety, massage should be gentle because the reflexes are increased. More vigorous massage may be employed in flaccid paralysis. Care should be taken not to injure the paralyzed muscles by compressing them against bone. As in hemiplegia, the limbs should be held in the position which will lead to the least amount of disfunction. Thus foot drop and flexion contractures of the hand should be minimized by suitable splinting.

Exercise, both active and passive, should be undertaken as soon as possible in order to maintain trophism and to diminish the tendency toward increase of connective tissue in the muscles and joints. Electrical stimulation assists in increasing muscle metabolism. While the patient is still in bed, exercises should be given to move limbs through their normal arcs of motion. When the patient becomes ambulatory it may be necessary to teach him how to walk by re-educating his muscles with the Frankel exercises or a walking apparatus. Underwater exercises, bicycling and rowing are valuable. Occupational therapy assists in muscle re-education.

heat, such as that obtained from a photothermal source may be used preceding massage and exercise. The whirlpool bath affords a satisfactory method of supplying heat and mild massage at the same time.

Inasmuch as the lower motor neuron arc remains intact in hemiplegia, muscular contractions can be produced by electrical currents. The desirability of this procedure is a subject of controversy. Some authorities believe that the vigorous contractions may produce injurious fatigue with resultant fibrosis. It has been argued that the only value of electric stimulation in spastic paralysis is the possibility that it may re-establish movement patterns in the brain. Others believe that electrically produced muscular contractions are of value. While there is danger that too vigorous and too numerous electrically induced contractions will damage the muscles, this method of treatment may be safely used if the unfavorable effect of overstimulation is kept in mind. With the return of voluntary function, active exercise should be instituted. Such exercise consists in attempts to draw a straight line with a pencil, to sort colored beads, to arrange wooden blocks, and the like. Muscles should be re-educated for acts commonly performed. For the lower extremity co-ordinated walking exercises are necessary.

If the patient's condition requires him to lie in bed for a long period of time, danger of development of decubitus ulcers may be minimized by good nursing—turning of the patient, keeping the skin dry, alcohol rubs, light massage, applications of powder, mild heat from a photothermal source, and ultraviolet radiation.

If flexion contractures develop, they may be treated with magnesium iontophoresis, which is accomplished by placing a pad soaked in magnesium sulphate over the region of the flexor muscles and connecting it to the positive terminal of the galvanic machine. When applied early, this has effected relaxation of spastic flexors. The action of magnesium iontophoresis is thought to be based on a curare-like influence exerted on the myoneural junctions. If the contracture has persisted for some time and fibrotic changes and shortening of tendons have occurred, this treatment will not be effective. Orthopedic measures such as the use of traction and splints then become necessary.

It is possible that electrical currents may exert a beneficial effect on the intracranial pathological condition. Galvanic and high frequency currents have been applied to the head for this purpose. A technique for calcium iontophoresis is described by Bourguignon. Cotton soaked in a 1 per cent solution of calcium chloride is placed on the eye opposite to the affected

side and connected by means of a small metal plate to the positive pole. The negative electrode is placed at the back of the neck. A current of 2 to 5 milliamperes is permitted to flow for one half hour. A series of fifteen applications is made at three week intervals, the first six treatments are administered daily, the remaining nine every other day. Cloetta and Waser demonstrated that the temperature of the tissue inside of the cranium of rabbits can be elevated by long wave diathermy applied to the head. The active hyperemia so produced may speed absorption of extravasated blood and lymph. Because of the danger of increasing the hemorrhage, high frequency currents, either long or short wave diathermy should not be used until a period of several weeks from the time of the initial attack has elapsed. It is difficult to evaluate the results of any therapy in hemiplegia because of the spontaneous improvement that takes place. However, it is our impression that converse heating by high frequency currents is of value in some cases of hemiplegia. In this treatment the electrodes are placed on the forehead and on the occiput and upper neck.

#### INTRACRANIAL TUMORS

Following removal of intracranial tumors, physical therapy is a useful means of hastening restoration of returning function. The paralyzed limbs may be heated by hot compresses, phototherapy, and whirlpool baths. Caution should be observed in applying heat, especially when there is loss of thermal sensation. If the paralysis is of the spastic variety, massage should be gentle because the reflexes are increased. More vigorous massage may be employed in flaccid paralysis. Care should be taken not to injure the paralyzed muscles by compressing them against bone. As in hemiplegia, the limbs should be held in the position which will lead to the least amount of disfunction. Thus foot drop and flexion contractures of the hand should be minimized by suitable splinting.

Exercise, both active and passive, should be undertaken as soon as possible in order to maintain trophism and to diminish the tendency toward increase of connective tissue in the muscles and joints. Electrical stimulation assists in increasing muscle metabolism. While the patient is still in bed, exercises should be given to move limbs through their normal arcs of motion. When the patient becomes ambulatory it may be necessary to teach him how to walk by re-educating his muscles with the Frankel exercises or a walking apparatus. Underwater exercises, bicycling and rowing are valuable. Occupational therapy assists in muscle re-education.

## CEREBRAL PALSY

Cerebral palsy occurs in adults as a result of intracranial disease and injuries.

In children the disease may be either congenital (Little's disease) or acquired. Treatment consists in the use of mild heat, massage, and manipulation of the paralyzed extremities.

Treatment of spastic paralysis requires special training on the part of the technician. Phelps and Carlson have done a great deal of work toward rehabilitation of sufferers from cerebral palsy. At first, an attempt is made to relax one muscle group at a time. Then, simple movements are performed over and over again until the patient can do them without involuntary contractures. Exercise is of value in the care of athetoid, but not of spastic patients.

Muscle re-education may be conducted with groups of patients. As Ryerson points out, instruction given to a group has the advantage of providing the stimulus of competition and association with similarly afflicted children. When prolonged use of physical therapeutic measures fails to improve the condition of the muscles, surgical procedures must be resorted to. According to Phelps the spastic type may be benefited by surgical intervention, while the athetoid requires physical therapy.

## LESIONS OF THE SPINAL CORD

Paralysis which is the sequela of disease or injury to the spinal cord is treated with measures similar to those used in the care of lower motor neuron lesions. Cord damage occurs in myelitis, syringomyelia, spinal cord tumors, and multiple sclerosis. In multiple sclerosis, therapeutic elevation of systemic temperature produces temporary improvement which may last for a period of several years or for only a few weeks.

Physically produced fever therapy combined with chemotherapy is of definite value in neurosyphilis. The percentage of remissions obtained with this treatment in dementia paralytica is greater than that following malaria therapy. The reversal of serological reactions occurs (if it does occur) in a shorter period of time. Moreover in temperature elevation produced by physical means the mortality rate is much lower than it is in malaria therapy. Artificial fever therapy is a valuable therapeutic adjunct in gonococcal and meningococcal meningitis. The symptoms of Sydenham's chorea usually disappear in response to physically induced pyrexia.

## TRAUMATIC INJURIES TO THE LOWER MOTOR NEURONS

The extent of the damage may be determined by the history and physical findings, including functional and electrical tests

Where a motor nerve has been severed, treatment must be directed toward coaptation of the nerve ends Pollack summarized the use of physical therapeutic procedures in such cases

'Where a primary or secondary suture is indicated immediately, physical therapy must assist the operative procedure. When it is felt advisable to defer the operative procedure, physical therapy must be initiated promptly to the end that when the nerve regenerates it will activate a mechanism capable of adequate movement.

"The above indications are met by treatment with splinting to prevent overstretching of paralyzed or weak muscles, massage to improve the nutrition of the parts, to prevent adhesions of scars and fibrosis, and to conserve the bulk of the muscle, passive movements to prevent deformity from shortening, interphalangeal fibrosis, ankylosis of joints, active exercise to conserve the unparalyzed muscles, to stimulate circulation, to educate synergistic muscles to assume the function of paralyzed muscles, electrotherapy to conserve the vitality, prevent complete atonia, and increase the contractility of paralyzed muscles, and hydrotherapy and thermotherapy to assist in nutritional conservation and to facilitate other methods of treatment

"In cases treated some time after injury, splinting and the other procedures are indicated to correct deformities, as well as to restore function. Here passive movements must include stretching of shortened muscles and tendons, and mechanical devices constructed to assist in this function. Corrective exercises and occupational therapy play a large part in the correction of such deformities."

The motions lost through injury to important nerves are summarized in Table IV (page 490)

Pollack points out that the stimulating electrical currents (interrupted galvanic and sinusoidal) should not be applied until two weeks following injury. When treatment is started, care should be exercised not to produce fatigue. The sinusoidal current is less painful than the interrupted galvanic. It should be applied with small electrodes in order that only the paretic muscles will be stimulated. Contractions in muscle groups which result when large electrodes are used, should be avoided. Passive movement may be permitted about two weeks postoperatively.



TABLE IV  
 MOST FREQUENT FORMS OF PERIPHERAL PARALYSIS. (After Kovacs)

NERVES	USUAL CAUSES	CHARACTERISTIC PICTURE	SENSATIONS LOST	MOTIONS LOST	SPLINT USED
Facial	Fractured skull, facial wounds, operation	Lack of expression, drooping of lower eyelid; face pulled to sound side	None	Winking of forehead, closing of eye and corner of mouth	Elastic or adhesive straps to prevent sagging of face
Circumflex	Dislocation of shoulder	Shoulder flattened	Over middle of deltoid	Abduction of arm, external rotation weak	Abduction splint for upper arm
Musculospiral (radial)	Fracture of humerus, wounds on upper arm	Drop-wrist; infolding of thumb, little trophic change	Small area at base of the thumb and index finger on dorsum of hand	Extension of wrist and metacarpophalangeal joints; grip weak	Forearm in cock-up splint up to proximal interphalangeal joint
Ulnar	Injuries at the elbow or wrist	Claw-hand; first finger joints in hyperextension, other 2 in flexion	Little finger, half of ring finger, ulnar side of hand to wrist	Finer movement of the fingers (spreading)	Abduction splint for upper arm
Median	Injuries at the elbow or wrist	Flat or ape-hand, marked trophic changes	Larger thumb, index, middle and half of ring finger on palm; corresponding area on dorsum except thumb	Coarser movements of hand and opposition of thumb	Abduction splint for upper arm
Brachial plexus	Dislocation of shoulder, forcible traction of the arm (indirect violence); obstetrical paralysis	Varies with involvement of different roots	Usually small except when whole plexus involved	Varies with involvement of different roots	Varies with extent of involvement
External popliteal	Wounds about head of fibula; pressure of cast	Drop-foot	Dorsum of foot, outer side of leg	Dorsiflexion of leg and extension of toes	Straight angle splint

Inasmuch as regeneration of nerve after section or suture is at the rate of about 1 mm a day, active exercise cannot be instituted until four months have elapsed. Heat should be applied carefully since thermal sensation is absent. Massage should at first consist of superficial stroking, later deep stroking and gentle kneading may be employed. Friction can be applied to scar tissue. The heating and massage effects of whirlpool baths help to relieve pain.

Spurling, describing the treatment of peripheral nerve injuries in the European theatre of operations in the second World War, stated that inasmuch as experiments and clinical studies indicated that daily galvanic stimulation of denervated muscles will prevent atrophy and retard fibrosis, this measure was employed as a routine in all cases. Treatment was begun with 15 brisk contractions daily and progressed gradually to 30 contractions. When casts were used for post-operative immobilization, windows were cut over the bellies of the paralyzed muscle groups and galvanic stimulation was begun the day after operation. Other measures included massage, active and passive motion, and the use of dry and moist heat as indicated. Particularly careful attention was given to the active and passive motion of small joints. Fixation by splints was kept at a minimum, detailed instruction of the patients in respect to the care of their own joints being considered more important than mechanical methods of fixation.

Grodins, Osborne, and Ivy call attention to the two opposed concepts of the etiology of atrophy in denervated muscle—the atrophy of disuse and the atrophy of exhaustion. The theory of the atrophy of disuse is supported by the facts that (1) immobilized muscles with intact nerve supply will undergo atrophy (Tower), (2) contraction of denervated muscle by passive motion or by active contraction electrically produced will prevent or delay atrophy (Fischer, Solandt and Magladery).

Arguments against the theory of atrophy of disuse are (1) histologically the atrophy of disuse and denervation are not identical (Tower), (2) denervated muscle is not at rest but is in a state of continuous, fine, irregular fibrillation (Langley and Kato, Solandt and Magladery).

It is obvious that if denervation atrophy is due to exhaustion, electrical excitation of muscles would be contraindicated unless it be of help in influencing fibrillation or increasing blood flow. The reaction of muscle and nerve to electrical stimulus as Grodins and his co-workers point out, depends on (1) the form of the current, (2) the current intensity, and (3) the duration of current flow. They indicate that the ideal stimulating current should consist of a series of pulses of instantaneous rise which gradually increase

in intensity from threshold to maximal and in frequency from zero to 100 per second. For denervated muscle, the ideal current should be in form similar, but the individual pulses must be of longer duration and lower frequency and perhaps of more gradual rise. Thus, normal muscle will respond with smooth tetanic contraction to a 100-cycle wave surged at 20 to 30 per minute. A recently denervated muscle may give a similar response to a similar cycle wave. Further experiments showed that stimulation with a 25-cycle alternating current for ten to fifteen minutes daily was markedly effective in retarding atrophy in the denervated gastrocnemius muscle of the rat.

### ANTERIOR POLIOMYELITIS

Physical measures have come to play an increasingly important part in the treatment of anterior poliomyelitis because of the teachings of Sister Kenny. In the past, medical attention had been focused on the pathological change involving the anterior horn cells, with its resultant flaccid paralysis. In accord with the older concepts of the disease, physical therapy with the exception of such measures as short wave and x-ray radiation applied to the region of the spine (procedures followed in France), was not applied until about six weeks following the onset of the disease, that is, when the acute stage was passed. During the initial period of the disease, the patient was given complete rest. Weak or paralyzed muscles were held in position by splints or casts. The affected muscles were thus held in a shortened position with approximation of their regions of origin and insertion. The deltoid, for instance, was put up in an aeroplane splint; the foot was held in dorsiflexion if the anterior leg muscles were involved. Then, heat, massage and re-educational exercises were employed. Exercises were administered under water in pools and in tanks.

### KENNY CONCEPT OF POLIOMYELITIS

*Symptoms.* Sister Kenny called attention to the existence in poliomyelitis of symptoms other than paralysis. She showed that during the acute stage of the disease, some muscles are hypertonic and hyperirritable and tend to approximate their points of origin and insertion. She termed this state "muscle spasm" (Fig. 270). Muscles so involved show involuntary contractions (fibrillations and fasciculations) and give rise to pain which is aggravated by attempts to lengthen the muscle. She pointed out that muscle spasm can also produce attitudes which heretofore have been attributed to flaccid paralysis. For example, spasm of the gastrocnemius with its resultant shortening

will cause the foot to be held in *plantar flexion*, a position which might be attributed to paralysis of the anterior leg muscles. Inability to abduct the arm may *not result from paralytic involvement* of the deltoid, but rather from

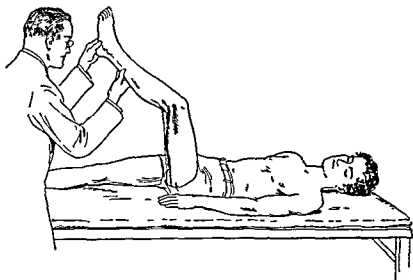

FIG 270 Spasm of hamstring muscles in poliomyelitis

spasm of the adductors of the upper extremity—the pectoralis major and latissimus dorsi muscles. If the muscle spasm is left untreated, structural changes begin to occur in the muscle, which becomes contracted. Contracture may follow, with the contractile muscle tissue becoming largely replaced by fibrous tissue. At this stage, surgery offers the only possibility for improvement.

In accordance with the Kenny concept, splinting is contraindicated because a muscle in spasm will contract all the more when it is stretched. For example, a cast which holds the foot in dorsiflexion increases the spasm of the *gastrocnemius*. Similarly, an abduction splint for the arm increases the spasm of the pectoral muscles, while the regions of insertion and origin of the deltoid are approximated, thus leading to permanent shortening. It is important to treat the spasm as early as possible, because untreated muscles shorten and therefore cause deflections from the normal alignment of the body with resultant interference with normal functioning.

When a muscle is in spasm, its opponent will not attempt to contract because (1) such contraction would increase the spasm in the opposing muscle (as in the lack of use of the deltoid in pectoral spasm) and because (2) it may be stretched beyond its normal position and therefore be unable to contract from its point of insertion as, for example, the anterior tibial

when there is gastrocnemius spasm. Disuse of a muscle opposing one in spasm can result in its inability to function because of a physiological block which develops along the course of the neuromotor pathway. The pseudo-paralysis so produced is termed "mental alienation" by Sister Kenny. The alienated muscle is never painful. Alienation can usually be determined when stimulation is begun.

A third symptom emphasized by Sister Kenny is that which she terms "in-co-ordination." The patient is unable to direct his motor impulses properly. This condition should not be confused with substitution which is the conscious use of one muscle to assist in the motion performed by another one. The patient is not aware of his un-co-ordinated movements. Thus, the motor impulses may be directed to the wrong muscle, for example, to the adductor when the desire is to contract the abductor or, to the wrong part of a muscle as, for example, during flexion of the knee when the contraction is begun in the upper portion of the hamstring muscles rather than in the region of their insertion below the knee. In-co-ordination is usually noticed when the actual treatment is begun. One observes that only the muscle intended for the motion to be performed contracts, and that the muscle starts the contraction from the region of its insertion.

Sister Kenny recognizes that actual paralysis does occur as a result of motor nerve damage. However, it is her contention that her treatment serves to diminish the amount of atrophy and atrophic changes which ordinarily follow. She has observed that the muscle spasm which always precedes paralysis is of short duration and extremely severe.

*Evaluation of Clinical Symptoms.* "Muscle spasm" occurs in all patients with poliomyelitis. As it inhibits muscle function it can be responsible for the inability of the patient to move freely. In nearly all instances there occurs spasm of the neck and the back muscles. During the acute stage, analysis of muscle involvement is made by inspection only. Muscle testing is avoided as this may cause a great increase in spasm. The observer notes deviations from the normal alignment and increase and decrease in folds and sulcuses; prominence of tendons; flattening or prominence of muscles and atrophic changes. Extent of pain is also an indication of the degree of involvement. The following are some of the most frequently encountered evidences of muscle spasm:

*Increased cervical lordosis.* The drawing back of the head is caused by spasm of the posterior neck muscles. If severe, this condition may interfere with swallowing and breathing. The sulcus at the base of the skull is usually deepened and the muscles are prominently contracted. The patient is unable

to raise his head and function of the sternocleidomastoids may be lost (alienation)

*Lateral flexion of the head* is due to spasm in one upper trapezius. If the scapula is not fixed, the spasm of the upper trapezius will cause elevation of the shoulder.

*Rotation of the head* is caused by spasm of the sternocleidomastoid on the opposite side. The sternocleidomastoid tendon is usually prominent.

*Cupping of the shoulder, flattening of the chest, increase of thoracic cleft, adduction of arm close to side.* Any one or all of these symptoms can be produced by involvement of the pectoral muscles. If this is severe, it may interfere with action of the intercostals and so cause difficulty in breathing. The patient would then suffer from embarrassment of inhalation and be unable to hold his breath. He might attempt to use one or both sternocleidomastoids.

*Increase in lordosis* may be caused on one or both sides by (a) spasm in the erector spine group, (b) spasm of the quadratus lumborum (the result is frequently slight shortening of one leg on the side of the lordosis), and (c) spasm in either the psoas, rectus femoris, or sartorius. The psoas may pull from its origin at the lumbar vertebrae when the thigh is stabilized and thus increase lumbar lordosis. The sartorius or rectus femoris muscles may pull from their tendinous insertions at the spines of the ilium, and cause a "dropped" pelvis and an increase in lordosis. The tendon of the sartorius muscle is prominent when the muscle is in spasm.

Spasm of the muscles of the back will prevent the patient from sitting up. The abdominal muscles usually become stretched and alienated. They resume their function as soon as the spasm of the back muscles is "released". Spasm of the muscles on one side of the spine may produce scoliosis and prominence of the abdominal muscles on the opposite side.

*Pelvic obliquity* is caused by spasm of the oblique abdominal muscles on one side. The anterior superior spine is usually prominent and the abdomen appears flat on the affected side. There may also be shortening of the leg on the same side.

*Deviation of the umbilicus* is caused by spasm in a portion of the rectus abdominis muscle.

*Widening of the natal cleft* is caused by spasm of both gluteus maximus muscles. Deviation of the natal cleft occurs when one gluteus maximus is in spasm.

*Obliteration of the gluteal fold* is due to spasm of the gluteus maximus and biceps femoris.

*External rotation of the thigh.* This is most frequently caused by spasm of the tensor fascia lata and biceps femoris. It can also be caused by spasm of the external rotators or of the gluteus maximus. .

*Flexion of the knees* is produced by spasm of the hamstrings. This prevents functioning of the quadriceps.

*Foot held in plantar flexion (footdrop).* Spasm of any or all of the posterior calf muscles is responsible for this condition. If the heel is held in supination the medial head of the gastrocnemius is the more involved; if in abduction, the lateral head. In this condition, functioning of the anterior muscles of the leg, particularly the anterior tibialis, is inhibited. A patient suffering from spasm of the gastrocnemius may attempt to diminish his discomfort by flexing the knee.

*Foot held in dorsiflexion.* Spasm of the anterior tibial causes slight inversion. The tendon of the muscle is prominent. The tendons of the peroneals or tibialis posticus may also be prominent owing to inversion or eversion of the foot produced by spasm.

*Pes cavus* is caused by spasm of the intrinsic foot muscles.

During the early stages of the disease it is difficult to determine how much of the involvement is attributable to actual paralysis and how much to "alienation." Sister Kenny believes that true paralysis usually involves an entire extremity, whereas non-functioning of individual muscles can be attributed to alienation, particularly if there be spasm in the opposing muscle.

Treatment. Nursing care. Good nursing forms an important part of the treatment of patients suffering from poliomyelitis. On admission to a hospital, the patient is placed in a bed especially prepared in the following manner: (1) A large board is placed under the mattress. (2) Two wooden blocks about 4 inches square and placed at either side, separate the end of the mattress from a wooden board which is put at the foot end of the bed. (3) This foot-board keeps the weight of the bedclothes from the feet and helps to preserve or to re-establish the normal standing reflexes (Fig. 271). (4) Woolen blankets are used instead of sheets because sheets may increase the spasm. (5) A rubber air ring is substituted for a pillow or no pillow is employed because of the possibility of increasing spasm in the muscles of the neck. The patient is handled as little as possible in order to avoid any aggravation of spasm. An enema is administered shortly after admission. Occasionally catheterization for urinary retention is required. If there is difficulty in swallowing, the patient should be given half a teaspoonful of water administered with a spoon. Drinking tubes or straws are not used, nor is the patient fed through nasal or stomach tubes at any time as these

may increase spasm. When necessary artificial feeding is given by the rectal or intravenous routes.

During the acute stage of the disease, the patient is permitted to lie in



FIG. 271. Mechanical wringer for hot compresses.

any position which he finds comfortable. As soon as possible, however, he should be encouraged to assume the position of natural alignment of the body. This position is considered to be the one which he would assume if he were standing correctly. If a large number of muscles are involved in spasm, sponge baths are avoided during the first few days. Unless he is unusually restless the patient is turned so that he lies in the prone position for a period of one hour twice a day. During the acute stage, the patient may be extremely restless and, if so, he must be turned more frequently. Primary attention is given to embarrassment of respiration if it be present. Such respiratory difficulty may be caused by spasm of the diaphragm, spasm of the intercostals or non functioning of these muscles because of spasm of the pectorals, or it may be of bulbar origin.

*Packs.* The muscles which are in spasm are treated with hot fomentations. Other less cumbersome forms of heat have been tried but have not proved so effective. The fomentations consist of woolen material (such as old blankets) cut into triangles or squares to fit the part to be treated. These hot fomentations are covered with a layer of oil silk or rubber sheeting which, in turn, is covered with another piece of woolen material. The cloth which is applied directly to the skin is first sterilized by immersion in boiling water for twenty



*External rotation of the thigh.* This is most frequently caused by spasm of the tensor fascia lata and biceps femoris. It can also be caused by spasm of the external rotators or of the gluteus maximus. .

*Flexion of the knees* is produced by spasm of the hamstrings. This prevents functioning of the quadriceps.

*Foot held in plantar flexion (footdrop).* Spasm of any or all of the posterior calf muscles is responsible for this condition. If the heel is held in supination the medial head of the gastrocnemius is the more involved; if in abduction, the lateral head. In this condition, functioning of the anterior muscles of the leg, particularly the anterior tibialis, is inhibited. A patient suffering from spasm of the gastrocnemius may attempt to diminish his discomfort by flexing the knee.

*Foot held in dorsiflexion.* Spasm of the anterior tibial causes slight inversion. The tendon of the muscle is prominent. The tendons of the peroneals or tibialis posticus may also be prominent owing to inversion or eversion of the foot produced by spasm.

*Pes cavus* is caused by spasm of the intrinsic foot muscles.

During the early stages of the disease it is difficult to determine how much of the involvement is attributable to actual paralysis and how much to "alienation." Sister Kenny believes that true paralysis usually involves an entire extremity, whereas non-functioning of individual muscles can be attributed to alienation, particularly if there be spasm in the opposing muscle.

Treatment. Nursing care. Good nursing forms an important part of the treatment of patients suffering from poliomyelitis. On admission to a hospital, the patient is placed in a bed especially prepared in the following manner: (1) A large board is placed under the mattress. (2) Two wooden blocks about 4 inches square and placed at either side, separate the end of the mattress from a wooden board which is put at the foot end of the bed. (3) This foot-board keeps the weight of the bedclothes from the feet and helps to preserve or to re-establish the normal standing reflexes (Fig. 271). (4) Woolen blankets are used instead of sheets because sheets may increase the spasm. (5) A rubber air ring is substituted for a pillow or no pillow is employed because of the possibility of increasing spasm in the muscles of the neck. The patient is handled as little as possible in order to avoid any aggravation of spasm. An enema is administered shortly after admission. Occasionally catheterization for urinary retention is required. If there is difficulty in swallowing, the patient should be given half a teaspoonful of water administered with a spoon. Drinking tubes or straws are not used, nor is the patient fed through nasal or stomach tubes at any time as these

However, they are not restricted in their movements (unless there is danger of falling out of bed) If a child insists on sitting up, he need not be forced to lie down, because he would be unable to sit up unless his condition per-

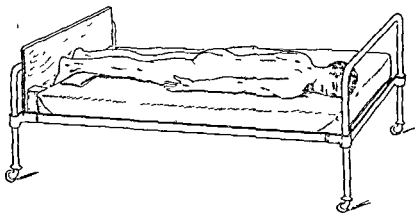

FIG 272 Foot board with space separating it from mattress

mitted him to do so It was thought formerly that scoliosis might result if patients were permitted to sit up too soon Postpoliomyelitis scoliosis is now explained as due to unreleased spasm in part of the erector spinae muscles This spasm must therefore be entirely released if scoliosis is to be avoided The sitting position is not responsible for development of scoliosis unless there is marked wasting of one buttock In such cases a felt pad placed under the buttock will compensate for the wasting Formerly, children were immobilized for a period of one year or more and yet marked scoliosis developed

When the patient is in the supine or prone position, the entire plantar aspect of the foot including the heel is placed against the foot board except when spasm of the gastrocnemius exists Such spasm would be aggravated if the feet were held against the board (Fig 272)

*Re education* The re-educational technique taught by Sister Kenny is based on her conception of the anatomy of muscles and their action She classifies muscles in a novel manner, emphasizing the synchronization and rhythm of muscle action According to her classification, muscles are divided into two major groups (1) those that contract within their normal resting length (as, for example, the biceps), and (2) those that must be removed from their normal resting length before normal contraction is possible in order to perform their primary function (as, for example, the triceps)

She believes that consideration should be given to the mode of origin and insertion of a muscle (fibrous or tendinous), and that whether it has one or more origins and one or more insertions, and more than one action should

minutes. At the bedside these heated cloths are removed from the boiling water and passed twice through a tight mechanical wringer (Fig. 271). For best results, this pack should be extremely hot, and it must be wrung almost dry if burns are to be avoided. This procedure, therefore, provides initial application of extreme heat to the skin followed by gradual cooling. In the acute stage of the disease, the packs are changed on an average of once every hour. If there is extreme spasm in any one area, the packs can be changed every fifteen minutes or even more often, as for instance when the patient experiences difficulty in breathing due to spasm of either the pectorals or the diaphragm. A pack applied to the whole body is not changed more often than once an hour. Otherwise, the patient becomes exhausted. Care should be taken not to overtire the patient with packing. Packs should not be applied so tightly as to restrict motion. Except for the shoulder and hip joints (which are covered by muscles) packs are not placed on joints. As a rule, patients are not awakened for the application of packs. Between packs, the skin is gently patted dry to remove perspiration. Fluids are administered as desired and sodium chloride is also given. Packing is usually applied during a twelve-hour period unless the patient is in great danger as a result of respiratory difficulty. Then, the packing may be continued during the entire twenty-four hours.

*Position of the patient.* While the patient is encouraged to assume a position of natural alignment during the early very acute stage, no effort is made to alter deviations from the ideal position caused by muscle spasm. When the lower extremities are held rotated, they can be restored to midline position by placing rolled towels at the side of the knee and ankle joints. If there is extreme lordosis, a towel roll can be placed temporarily under the knees. In the presence of severe abdominal spasm, it may be necessary to flex the thighs and knees at right angles and to support them with pillows. Concentrated packing is employed in these instances in order to permit gradual removal of the pillows during the ensuing week or two. When the patient is turned to the prone position, his feet are placed so that they extend beyond the edge of the mattress and a towel roll is put under the ankles in order that there may not be unnecessary stimulation of the gastrocnemius muscles. Undue stretching of the rhomboids is avoided by placing small pads or pillows under the shoulder. Care must be taken not to stretch the pectoral muscles by this procedure. If there be increased lordosis a pillow is placed under the abdomen while the patient is lying prone. If indicated, a towel roll is also put under the knees at the same time.

Children are taught how to maintain themselves in good body alignment.

lift up with his hip flexors, to stabilize his pelvis with the quadratus lumborum, to stretch out his leg, to place his foot forward on the ground and to push off with the other foot, and so forth

*Breathing* Instruction in breathing is given directly after admission of the patient This is particularly necessary in the presence of respiratory difficulties caused by muscle spasm As soon as some relaxation has been achieved by hot fomentations, instruction is given directed toward avoiding the use of improper muscles The patient is taught to fill the chest with air without using the sternocleidomastoids (indicating the region of the sternum) and to inhale through the nose He is asked to exhale through the mouth by "drawing his ribs together" and "pulling in his abdomen" The technician may assist in exhalation by exerting pressure on the lower angle of the ribs When there is weakness of the upper abdominal muscles, the patient is asked to hiss when exhaling If weakness exists in the lower abdominal muscles, he is taught to grunt

*Sitting up* The patient is told to raise his head without pulling down the corners of his mouth with the platysma muscles He then raises his shoulders off the table, at the same time contracting his abdominal muscles He is told to "roll up" and to "fold in" his abdominal muscles He is cautioned against pulling with his pectorals and against using his hands or arms The motion of sitting up is completed by flexion of the trunk on the thighs and bending over sufficiently to permit the head to touch the knees

Before the patient is discharged from the hospital he is required to meet the following functional tests

- (1) Sit up and touch his head to his knees
- (2) Raise both legs over the head and touch the floor while the knees are held straight
- (3) Raise legs and trunk simultaneously into a half sitting position
- (4) While in the prone position, raise back and legs simultaneously, causing equal contraction in all parts of the erector spinae group
- (5) While in the standing position, touch his knee to his nose
- (6) Touch heel to buttock
- (7) Stand on heels
- (8) Stand on toes
- (9) Bend knees fully, leaving heels on ground
- (10) Walk
- (11) Skip

*Results* Sister Kenny maintains that she has not observed residual paralysis of any trunk muscle in patients who have received her treatment from

be taken into account. According to her concept, the main action of some muscles is the stabilization of positions obtained by the contractions of other muscles. A muscle which has a tendinous origin and a tendinous insertion can produce motion of the structures at either of its ends. For example, the psoas can cause either flexion of the thigh or flexion of the pelvis on the trunk. In the Kenny system of re-education, care is taken that the muscle begins to contract at its point of insertion and that if there be more than one insertion (as in the hamstrings) there is equal pull at both tendons.

The process of re-education is divided into three phases: (1) stimulation, (2) passive motion, and (3) active motion.

*Stimulation.* The "alienated" muscle is moved through a small circular arc in order to stimulate the proprioceptive reflexes of the muscles, tendons and joints. This part of the re-education program may be carried out while active spasm is still present. Usually about three to four days after the onset, it is possible to move the part through a small arc of motion. Stimulation is then started and repeated three or four times daily. This stimulation is carried out while the patient is lying in bed. It is applied early in order to avoid the possibility of "complete alienation" of the muscles.

*Passive motion.* Passive motion is carried out in order to re-establish mental awareness. The patient is instructed concerning the motion to be performed, the muscle involved in that motion, and the point of attachment of that muscle. He is asked to concentrate on the idea of the action but not to make any voluntary attempt to perform the motion. All movements are guided by the operator. The manner in which the operator places her hands on the patient is of utmost importance. The part to be moved should be in good alignment and supported securely. The operator's hands should not cover the muscle which is to be moved. Passive motion is begun as soon as active muscle spasm ceases.

*Active motion.* When mental awareness has been re-established, the patient is asked to assist in the performance of a movement. Stress is placed on the rhythm of motion. The character of the motion is considered more important than its extent. As soon as possible, the patient is taught the rhythm of walking—flexion and extension of the hip and knee joints. Muscles are exercised in the same position in which they would move normally. All movements are carried out only while the patient is in the supine and prone positions.

*Walking.* The patient is permitted to stand when all muscle spasm has disappeared and co-ordination is established even in the presence of muscle weakness. The walking movements are taught first while the patient is in the supine position and then when he is able to stand. He is directed to

the anterior two thirds of the tongue becomes lost. In these patients the duration of the paralysis is longer than in those in whom the tongue is not involved. Patients suffering from Bell's palsy should be treated without delay.

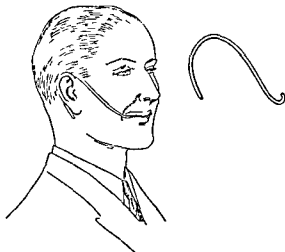

FIG. 273. Wire splint for Bell's palsy.

I have obtained good results in these cases by heat applied by a 1500 watt tungsten filament lamp at comfortable tolerance distance, and maintained for about thirty minutes, followed by the static brush discharge. Phototherapy can also be applied by means of the 260 watt carbon filament lamp. Sixteen out of eighteen patients treated during the first week of their paralysis made a complete recovery within three weeks. While spontaneous recoveries commonly occur in this disease, the rapid improvement obtained by heat therapy in so large a proportion of cases would be difficult to explain on a coincidental basis. Certain it is that no harmful effects resulted from early application of these measures. Although these findings are contrary to the usual teaching that patients with Bell's palsy should not be treated by any form of physical therapy until ten days or two weeks after the onset of their symptoms, I believe that it is in the early days of the disease that the possibility of exerting the most potent therapeutic influence exists.

To overcome the pull of the muscles on the healthy side of the face, the paralyzed side can be splinted by adhesive tape running from the angle of the mouth to the temporal region. Or, a wire covered with rubber tubing or gauze bandage may be bent and hooked into the inside corner of the mouth and over the ear on the paralyzed side (Fig. 273).

After the first ten days more vigorous treatment can be instituted with interrupted galvanic or sinusoidal current. Three or four contractions are sufficient at the start, these may be gradually increased daily. Other measures

the onset of the disease; that a small percentage of patients are left with paralysis of one or more extremities; and that patients with one completely paralyzed lower extremity can be taught to walk satisfactorily with the aid of Canadian crutches and without braces.

Cole, Knapp, Pohl, Daly, and many other American observers who have closely watched the Kenny method of treatment are enthusiastic about the results it achieves in the initial stages of poliomyelitis. I have observed patients treated by the Kenny technique. Pain and muscle spasm diminish on continued application of hot fomentations. Contractures and deformities appear to be prevented. The absence of splinting apparently does not have deleterious effects and the patients are much more comfortable than are those who are placed in splints. With the passage of time, a more exact evaluation of the results achieved by the Kenny approach can be made, and a better understanding may be had of the relationship between this and other methods of treatment.

The change in attitude that has taken place during the several years in which the results of the Kenny type of approach have been observed is possibly best exemplified by the action of the pediatric service of the hospital with which I am associated. Patients on this service suffering from poliomyelitis are now referred for treatment to the department of Physical Medicine and not to the orthopedic division. Certain it is that in many patients loss of function is not due solely to paralysis and that in these patients marked improvement occurs concurrently with the application of techniques advised by Sister Kenny. On the other hand, the loss of muscular contractions due to motor nerve destruction cannot be restored. The Kenny concept has stimulated research and the advocacy of procedures such as the use of prostigmine and of curare in the effort to influence muscular hypertonicity.

#### BELL'S PALSY

Paralysis of the facial nerve is one of the most common varieties of peripheral paralysis. Patients often give a history of exposure to cold drafts significantly near the onset of the symptoms; for example, in automobilists who have traveled with the window down on the left side, the left side of the face is affected. Frequently, too, there is a history of sore throat occurring a short time previously. This background suggests that a combination of infection and exposure to cold may be responsible for the onset of Bell's palsy.

The first evidence of the disease may be a sensation of discomfort or pain in the region about the ear. The onset of the paralysis may not be appreciated by the patient until his attention is called to it by some one else. If the nerve in the region of the chorda tympani is involved, the sensation of taste in

do not reach the causative factors. In some instances, converse heating by diathermy or the short wave current may give relief, in most cases it is ineffective. Sometimes, the addition of the galvanic current will produce



FIG 274 Rapid sinusoidal current applied for facial neuralgia (After Ulanski)

the desired effect. The electrode which covers the involved side of the face is connected to the positive terminal, while the negative terminal is attached to a large pad placed on the upper back. The current is gradually increased to the point of tolerance and held there for about thirty minutes. In Europe there are proponents for the use of quinine and aconite iontophoresis. Ulanski has secured very good results with a rapid sinusoidal current. His technique is as follows. Short wave diathermy is given for ten minutes. The rapid sinusoidal current is then applied in the manner to be described. The dispersive electrode, one and one half inches in diameter, is placed in front of the ear between the pinna and the lobe. The active electrode, about one half inch in diameter, is placed over the region of the mental, mandibular, supra orbital or infra orbital foramen. If there is involvement of the tongue or tonsil the active electrode is placed over the painful region. The current is gradually turned on until a strong contraction of the muscles occurs in the treated region. It is continued for one minute. When more than one division of the nerve is involved, the procedure is repeated. These treatments are administered daily until improvement is obtained, and then every second day (Fig 274).



consist of effleurage in the early stages, and later, deep stroking massage. The patient should perform active exercise in front of a mirror, while endeavoring to restrict the motion of the muscles on the healthy side by holding his hand over them. When the eyelids do not approximate there is danger that inflammation may develop within the eye. The eye may be covered with a shield to keep out foreign bodies. Irrigation with boric acid and instillations of silver nucleinate serve to diminish any inflammatory reaction which might occur. Under the regime just described many patients in whom the chorda tympani is not involved make relatively complete recoveries within three weeks. Patients seen after the first week may require from three to six months of treatment. Patients showing residual paralysis after six months may respond further to physical therapy. The slight contractures which develop in some cases after the stage of paralysis is passed, should be treated by heat.

#### NEURITIS AND NEURALGIA

The terms "neuritis" and "neuralgia" are frequently applied to inflammatory conditions that give rise to pain along the distribution of sensory nerves. Inflammation of the nerves occurs in diseases such as plumbism, arsenic poisoning, diphtheria, diabetes, and alcoholism. Inflammation in tissues contiguous to nerves also causes symptoms of "neuritis." Efforts to relieve the pain are directed toward removing the cause—administration of vitamin B<sub>1</sub>, sedatives, and physical therapeutic procedures. A local anesthetic injected into the tissue about a nerve will relieve the pain temporarily. Injections of alcohol have a more prolonged anesthetic action. Radiation by means of x-rays sometimes brings relief. If all these measures prove inadequate, it may become necessary to sever the irritated nerve.

As in myositis, fibrositis, and arthritis, physical therapy in the form of convulsive heating, galvanism and measures producing counterirritation, is employed to ameliorate the causative factors as well as the local condition in the nerve. Convulsive heating measures include diathermy and short wave currents. Counterirritation can be achieved by conductive heating—hot compresses, phototherapy, galvanism, iontophoresis with histamine, ultraviolet radiation and the Oudin type of diathermy current applied with vacuum or non-vacuum electrodes. Iontophoresis of local anesthetics may produce temporary sedation.

#### NEURALGIA OF THE TRIGEMINAL NERVE

Neuralgia of the trigeminal nerve is an intensely painful condition. Physical measures are useful to the extent to which they relieve the pain; they

these patients complained, may have been due to some muscle imbalance or spasticity secondary to the joint derangement, or to irritation of the nerve roots as they emerge from the bony foramina. Suspension by means of a

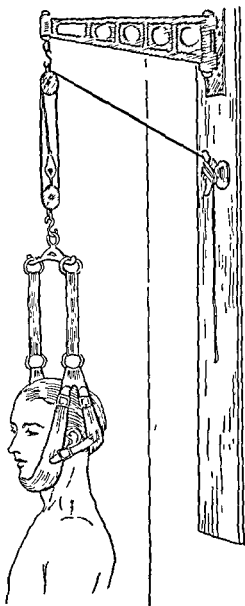

FIG 276 Use of Sayre head sling

Sayre head sling proved to be of diagnostic as well as therapeutic value. Intermittent periods of head traction conducted in the following manner gave relief. Traction was adjusted and fixed with the head halter as the patient rose on his toes as high as he could, then gradually let his heels down toward the floor. He was directed next to flex and extend his head

## BRACHIAL NEURITIS

The causes of pain along the distribution of the nerves of the brachial plexus are varied. Among them are such diseases as spinal arthritis, radiculitis, funiculitis, myositis, fibrositis, inflammation of the scalenus anticus

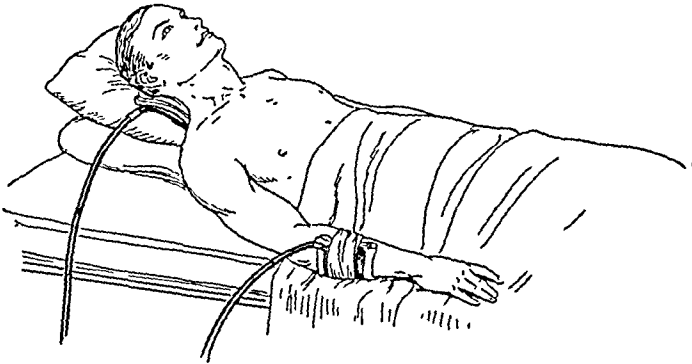

FIG. 275. Short wave current applied in the treatment of brachial neuralgia. Semi-flexible electrodes placed under neck and on forearm.

muscle, cervical ribs, bursitis, and faulty posture. Physical therapy is employed to influence the causative factors and to produce a sedative effect.

When the pain is due to arthritis of the cervical spine conservative heat is applied to the region of the cervical vertebrae as well as to the area complained of as painful. One electrode is placed on the side of the spinal column opposite to that of the involved region; the other is placed on the upper arm, forearm or hand, depending on the pain distribution (Fig. 275). In the acute stage little current should be used—considerably below heat tolerance and for periods of ten minutes—in order to avoid the possibility of causing painful exacerbation. In the chronic stage, twenty to thirty minutes, at a degree of comfortable tolerance, is the dosage. Treatments are given every other day. It is postulated that the value of this form of treatment lies in the fact that the pain is due to anoxemia of the nerve; and that the active hyperemia produced by the current flow overcomes the oxygen deficiency. When inflammation of the muscles of the neck and upper back is the causative factor, local heat and massage will usually cause the disappearance of the pain in the arm.

Traction with a head sling may be of service in relieving radiating pain due to cervical arthritis. Jostes found that laminograms of the cervical vertebrae in cases of this type revealed pathological changes in the region of the occipital condyles and atlanto-occipital joints. He believes that the neck pain and the pain radiating in the region of the shoulder, of which

osseous tuberculosis, herniation of the nucleus pulposus, thickening of the ligamentum flavum, and uterine fibroids. Obviously, when possible, the treatment should be directed against the cause. The physical therapeutic

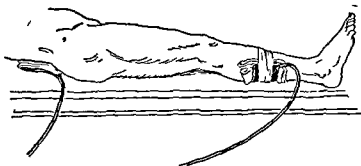

FIG 277 Short wave current applied for sciatica. One flexible electrode is placed under the lower back the other, under the calf of leg

measures which may be useful adjuvants include converse heat and galvanism. Treatments with the electrical currents are carried out with one electrode placed over the lower back and the other on that portion of the lower extremity to which the pain extends, at first they should be mild, and later more energetic if no exacerbation occurs. Heat can also be applied by means of hot baths, hot compresses and phototherapy. Massage, manipulation, assistive and active exercises, ultraviolet radiation, iontophoresis with histamine, contractile currents such as the sinusoidal and static, are among the measures which may give relief. Orthopedic procedures such as traction on the lower extremity, mobilization with splinting and plaster casts, wedging of shoes and arch supports, may be of use. Immediate relief may follow epidural injections of local anesthetics or of alcohol. X-ray therapy may be of service (Fig 277)

#### INTERCOSTAL NEURALGIA

Pain along the course of the intercostal nerves occurs in herpes zoster and in inflammations and trauma to the spinal cord and the structures of the thorax. Converse heating, ultraviolet radiation, galvanism, and the static brush discharge may alleviate the pain.

#### TABES DORSALIS

Fever therapy combined with chemotherapy has proved to be of value in the treatment of tabes dorsalis, though not all patients are relieved of their pains. In the effort to rehabilitate tabetic patients, exercises can be used.

In 1889 Frankel formulated precision exercises to re-establish muscular

and to move it to either side. Passive movements were then performed. After a period of one to several minutes the traction was released. The procedure was usually repeated three or four times. Intermittent traction can be applied in this way daily, every other day, or several times a week. A Thomas collar may be used as a supplementary measure if it seems helpful. Manual extension of the neck and manipulative procedures may bring prompt relief (Fig. 276).

#### SCALENUS ANTICUS SYNDROME

Inflammation of the scalenus anticus muscle can cause pain and paresthesia along the course of the brachial plexus. Direct pressure on the muscle may produce radiating as well as local pain. As the result of such pressure, the volume of the radial pulse may be diminished. Treatment consists of heat; massage; lessening of tension on the muscle by elevation of the shoulder with a sling or bandage or by elevation of the arm. If these measures fail to give relief, it may be necessary to cut the muscle. Reichert has called attention to the fact that in some cases the brachial plexus may be compressed between the scalenus anticus and scalenus medius muscles and the first rib. Spasm of the scaleni causes elevation of the first rib and so increases the compression. The symptoms are like those produced by cervical ribs—pain, tingling, and numbness in the cervical and scapular regions, in the shoulder and upper extremity, and also in the pectoral area.

Relief was obtained in most cases by rest, and by elevation of the shoulder on the affected side by means of a sling during the day, and by three pillows during the night. These pillows were placed so that the head, neck and shoulder were held forward while the patient lay on his back: two pillows were arranged to form an inverted "V" at the apex of which the third pillow was placed.

#### "SCIATICA"

Pain distributed along the course of the fibers of the sciatic nerve is usually referred to as "sciatica." It may be due to an inflammatory reaction within the nerve itself, as in arsenic and lead poisoning, syphilis, beriberi, and alcoholism. More often it results from inflammation of the structures which touch on the component branches of the sciatic nerve. These inflammations may also produce pain in the lower back. The etiological factor is determined by the history, physical examination, and laboratory findings. Among the causative diseases are lumbosacral or sacro-iliac arthritis or strain, malignant growths of the spine or cord, faulty posture, flat feet,

*Exercises in the Sitting Position* Nearly all the exercises just described can be done in the sitting position, and should be so practiced since it is difficult for the patient with tabes to sit down and to rise from a chair. Additional exercises are the following

*Exercise 1* Have the patient flex the knees slightly, bend the body forward, and then sit in a chair. The body must be inclined forward until he is actually in the chair.

*Exercise 2* In rising, have him first draw the feet backward under the chair, then incline the body by extending the knees, and slowly straighten up.

In preparation for walking, the patient should attempt to raise the leg from the floor and to lower it in the same and in adjacent places. This exercise is done first for one leg and later for both legs alternately. The difficulties of co-ordination are increased with weight bearing, and attempts at too rapid progress should be avoided.

*Exercises in Standing Position* The patient may support his weight with canes or on the backs of two chairs between which he stands.

*Exercise 1* Stand with feet close together and heels touching.

*Exercise 2* Stand with feet apart.

*Exercise 3* Stand on one leg. On heels. On toes. This exercise can be given without support.

#### *Walking Exercises with Support*

*Exercise 1* Walk ten steps forward placing the feet on lines which are 14 inches apart.

*Exercise 2* Vary the length of the step from 7 to 29 inches.

*Exercise 3* Make one step forward and bring the other foot into apposition. Walk ten steps in this manner.

*Exercise 4* Alternate half steps (14 inches) and full steps (28 inches).

When progress has been made, the walking steps should be varied by requiring the patient to walk in a circle, backward, in a figure eight, and so forth. When the patient can do these exercises satisfactorily, support should be gradually removed. Later, they may be attempted with the eyes closed.

*General Suggestions in Treatment* 1 Exercises should be practiced three or four times daily.

2 The progress from the lying or the sitting to the standing position should not be made too rapidly.

3 It should be borne in mind that difficulties in co-ordination are greater with weight bearing.

4 Exercising before a long mirror often aids the patient.

co-ordination in ataxia. The exercises are based on the assumption that the neuromuscular system can be re-educated if the motor mechanism is normal. As a certain amount of sensation is present, repetition of simple movements carried out methodically while the patient concentrates on the movement should aid in restoring co-ordination. The ability to co-ordinate muscles in intricate movements, as in gymnastics, piano-playing and the like, is gained through will power and constant repetition. Co-ordination implies united action of a combination of muscles to perform a desired movement. It is to be remembered that movement and not muscles are represented in the brain. In the exercises for treatment of tabes, the requisite movements are easy to perform, repeated frequently, and directed by the aid of vision. The patient must be given to understand that the treatment is symptomatic for the purpose of teaching co-ordination. The exercises are performed (1) lying, (2) sitting, (3) standing, and (4) walking. The patient should perform the exercises satisfactorily in the lying position before attempting them in any other positions. His progress will depend on the severity of the disease.

*Exercises in the Lying Position.* The patient lies on a hard bed with the head and shoulders raised in order that he may observe his movements. The first exercises are simple movements of the lower extremities in various directions. After they have been carried out satisfactorily with each leg, they should be performed simultaneously with both legs.

*Exercise 1.* Hip flexion with knee flexed, heel sliding along the bed but not raised. Return to the original position.

*Exercise 2.* Flexion as in Exercise 1, and then from the flexed position, abduction is performed. Return to the original position.

*Exercise 3.* Flexion of the hips with extended knee. Return to the original position.

Greater precision in movement is achieved with the following exercises:

*Exercise 1.* Flex one leg at the hip and knee and bring the heel to rest on:

- (a) The patella.
- (b) Along the shin bone.
- (c) On top of the ankle.
- (d) In the hollow of the hand of another person as position is changed.
- (e) On a part of the other leg indicated by the instructor.

An endless variety of movements may be performed by requiring the heel to go from one place to the other directly, or back to the original position. These movements must be repeated until the patient has developed a mental picture of them and can perform with the eyes closed.

major surgical procedures. After the animals had returned to a healthy state, their rectal temperatures, when taken by the operator, were consistently two or more degrees higher than when taken by the attendant in charge of the animal room. The association of the operator's presence with a very disagreeable experience, and that of the attendant with the pleasant experiences of food and care, produced a psychogenic rise of temperature in the one instance and not in the other. During the course of intramuscular temperature determinations I have observed that when the subject experiences a sensation of pain, the muscle temperature rises and the skin surface temperature diminishes. This adrenalin like reaction has been described by others. H. G. Wolff, for instance, showed that disagreeable mental impressions caused marked depression in the temperature of the skin surface. Today it is generally accepted that the psychic component in the patient's make up plays an important part in the response toward any form of therapy, be it physical, chemical, or psychic.

Good use is made of physical medicine in the treatment of psychically disturbed persons. The explanation for the value of these treatments may be both physiological and psychological. Miller believes that massage evokes a pleasant emotion due to the fact that the patient associates it with another similarly pleasant form of skin stimulation—the caresses bestowed upon him by his mother in his very early youth. Miller explains the pacifying influence of the prolonged continuous tepid bath on maniacal patients on the basis that in the patient's mind the bath is a return to his mother's womb, thus abating anxiety and producing muscular relaxation and mental appeasement. Whether these ingenious explanations are correct or not, the fact is that physical procedures are used extensively in psychiatric institutions.

#### INSOMNIA

Treatments which are recommended for insomnia are tepid baths for twenty or thirty minutes, massage of the head and neck at bedtime, and light meals or warm drinks taken just before retiring. Eye shades have been designed for the sleeper who is disturbed by light, and ear plugs for the person unable to sleep because of noise. The relaxation exercises advocated by Jacobson and by Rathbone may permit the tense individual to relax and fall asleep.

#### PSYCHOSES

In 1938, Cerletti and Binni reported shock treatment of psychoses, carried out with electrical current instead of metrazol and insulin. The electrical



5. Tabetic patients become fatigued very easily. Fatigue may be indicated by increased in-co-ordination, lack of attention, breathlessness, and rapid pulse.

6. Walking sideways is easier than walking forward.

7. Patients should be told that the exercises are for the purpose of teaching co-ordination, not to strengthen their muscles.

8. The apparatus devised by Frankel, with some modifications, may be made without much difficulty.

9. All the exercises should be first practiced with the eyes following the moving part and then with both eyes closed or looking away from the moving part.

Although these exercises have given good results in the treatment of the ataxia, they do not influence the course of the disease. They may be used for conditions other than tabes, in which there is lack of co-ordination and balance.

#### NEUROSES AND PSYCHOSES

For neurotic and psychically disturbed patients, physical procedures are of value not only because of the physiological changes which they induce, but also because of their psychological influence. Weir Mitchell first called attention to the fact that neurotic patients require a definite treatment regime consisting of rest, dietary advice, and physical therapy. At the start of treatment, light stroking massage given over the entire body induces relaxation. As the patient progresses toward recovery, massage may be applied more strenuously. It is administered every day and followed by a period of rest. As his sense of fatigue diminishes the patient is put through a series of exercises, at first passive and later active and of increasing strenuousness. Cabinet baths followed by the needle shower and Scotch douche, applied particularly along the spine, help to speed convalescence.

Mock has called attention to the neurotic factor in patients who complain of pain in the back when an organic lesion has been cured or never existed. This form of traumatic neurosis responds to heat, massage, exercise, manipulation, and occupational therapy. Polmer has obtained brilliant results in cases of hysterical paralysis, especially those of recent origin, by intensive physical therapy given in conjunction with psychotherapy. Hysterical aphonia, hysterical deafness, functional blindness, functional loss of smell and taste, and psychogenic retention of urine were included in his series of cases.

That psychical reaction and physical changes are interrelated is well known. I have observed psychogenic fever in dogs which had been subjected to

For satisfactory treatment this voltage should range from about 80 to 150 with a milliamperage of about 600. The threshold for the production of a convulsion is said to be about 30 milliamperes. The duration of the current flow is controlled by an automatic switch which is constructed so that the current will continue for from one tenth to one second. As the current begins to flow there is immediate loss of consciousness. Generalized tonic contractions occur all over the body, lasting for about ten seconds. The convulsion which is epileptiform in type, lasts about fifty seconds during which time the face becomes flushed. A clonic stage follows in which the face becomes cyanotic and there is frothing at the mouth. The pupils become widely dilated and fixed. The patient has no recollection of the shock because of the amnesia which it induces (Fig 278).

Hydrotherapy is another measure which plays an important part in the care of the psychically disturbed individual. The continuous bath produces sedation in stages of excitement. The water is held at a temperature of about 94° to 96° F. The duration varies from one to twenty four hours, depending on the intensity of the excitement. Usually the initial period is about one hour, successive periods are for about one and one half hours, twice daily. For very excitable patients the bath may be given three times a day for two or three hours at a time, or continuously. An ice cap or cold wet towel applied to the head makes the patient comfortable. Wet packs may be substituted for continuous baths when patients are much disturbed or when the continuous bath is not available (page 46). Patients suffering from depression are given stimulative treatments, consisting of sprays and douches preceded by electric cabinet baths. A warm needle spray followed by a fan douche at increasingly lower temperatures is an effective procedure. The Scotch douche is of help to patients who can tolerate it, particularly for those who suffer from neurasthenia and catatonia (page 63). Barnacle warns that the electric cabinet may be dangerous in the treatment of chronic alcoholism and other toxic conditions, because it may produce a rise in temperature and cause cerebral edema. He advises that these treatments should not be administered in the care of toxic, alcoholic, and delirious patients until at least ten days or more of conservative treatment have elapsed. The use of fever therapy in the treatment of general paresis is discussed on page 195.

#### MUSCULAR DYSTROPHIES

Physical therapy has a limited place in the treatment of muscular dystrophy. Because the muscles fatigue easily, massage and electrical stimulation must be used with caution. So, also, with passive and active exercise. Ultraviolet

method bids fair to replace the others in the treatment of some psychoses because it is less disagreeable, safer, and apparently as effective. The details of the technique employed vary somewhat with different workers. A satis-

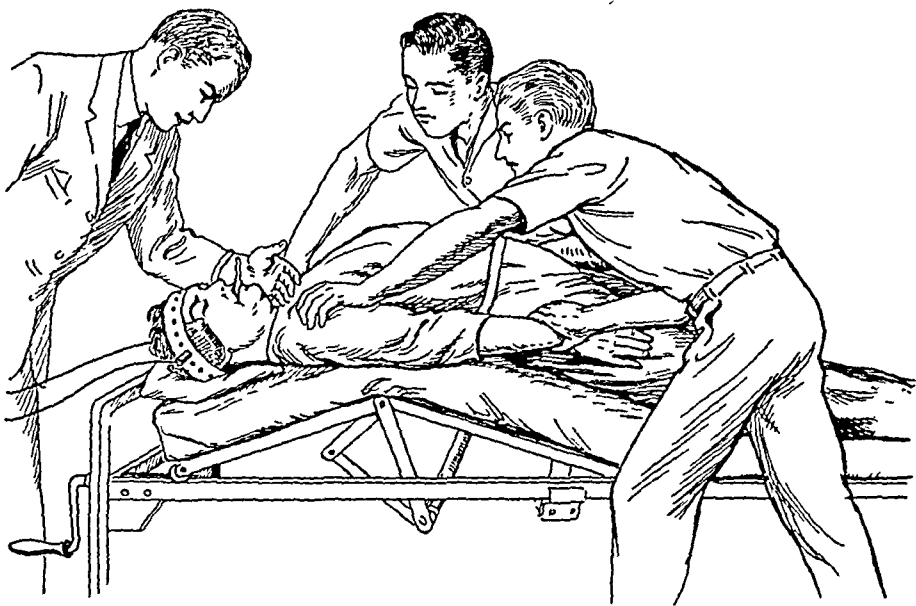

FIG 278. Technique of electroshock therapy. Patient prepared to receive current. The electrodes, soaked with a 25 per cent saline solution are held firmly against the temples by a perforated rubber bandage. The patient lies with his head at the foot end of a hospital bed. His back is hyperextended with the mid-dorsal region as the pivot of extension in order to minimize the possibility of vertebral fracture. To avoid fractures of the limbs, the upper and lower extremities are immobilized in adduction and extension. Two attendants, one on each side of the patient, are needed. Each attendant holds one hand on the patient's shoulder and with the other grasps the patient's hand, holding it to the patient's hip. He immobilizes the lower extremity by resting his forearm on the patient's thigh. The patient's head rests on a pillow to minimize the extension of the neck. A mouth piece is inserted and held in place by the patient. A third assistant stands ready to resist the wide opening of the mouth in order to avoid dislocation of the jaw. During the convulsion, this operator also prevents the head from moving violently from side to side. The hold on the patient during the convulsion, while firm, is yielding. The objective is to diminish the intensity of the convulsive movements. The assistant managing the head does not hold the jaw until after the current has been administered, in order to avoid receiving part of the current himself. When ready, he orders the two assistants at the sides of the patient to bear down and at the same time signals the operator at the machine to press the shock button. (After Almansi and Impastato.)

factory method is as follows: Two electrodes moistened with salt solution are placed on either side of the head at the junction of the temporal and parietal bones, and held in position by means of a clamp. Electrode jelly is smeared over the skin to insure good electrical contact. The voltage is adjusted until a current flow of one milliamperere is indicated. It is thus possible to calculate the resistance of the tissues of the head. This varies from 450 to 1200 ohms. A switch is then thrown to bring the head into the treatment circuit and the voltage is adjusted to correspond to the measured resistance.

- MOCK, H E Physical therapy in back injuries In Principles and Practice of Physical Therapy Hagerstown, Maryland, Prior, 1932, Vol II, Chap 16
- OBER, F R Physical Therapy in Infantile Paralysis *J.A.M.A.*, 110 45-46, 1938
- PHELPS, W M Birth injuries In Practitioners (The Library of Medicine and Surgery) New York, 1936, Vol IX, p 935
- POHL, J F Kenny treatment of poliomyelitis *J.A.M.A.*, 118 1428, 1942
- POLLACK, L J Physical therapy in peripheral nerve injuries In Principles and Practice of Physical Therapy Hagerstown, Maryland, Prior, 1932, Vol II, Chap 7
- RATHBONE, J Residual Neuromuscular Hypertension Implications for Education New York, Columbia University, 1936
- REICHERT, F L Compression of brachial plexus *J.A.M.A.* 118 294, 1942
- RYERSON, E W Physical therapy in cerebral spastic paralysis In Principles and Practice of Physical Therapy Hagerstown, Maryland, Prior, 1932, Vol II, Chap 9
- SOLANDY, D Y, and MAGLADERY, J W Relation of atrophy to fibrillation in denervated muscle *Brain* 63 255, 1940
- SPURLING, R G Peripheral nerve injuries in European Theatre of Operations *J.A.M.A.* 129 1011, 1945
- ULANSKI, B Modified rapid sinusoidal current for trigeminal neuralgia *Arch Phys Therapy* 21 275-282, 1940

radiation can be applied for its general effect. In the treatment of myasthenia gravis electricity is said to be contraindicated because of the ease with which the muscles fatigue.

## REFERENCES

- BARNACLE, C. H. Physical therapy in psychiatry. *Physiotherapy Rev.*, 19 : 282-285, 1939.
- BOURGUIGNON, G. Localisation de l'excitation dans la méthode dite "monopolaire" chez l'homme. *Rev. neurol.*, 27 : 553, 1914.
- CERLETTI and BINI. *Bull. Acad. de méd. de Roumanie.* 64 : 36, 1938.
- CLOETTA, M., and WASER, E. Beitrage zur Kenntniss des Fieberanstieges. *Arch. f. exper. Path. u. Pharmakol.*, 73 : 396, 1913.
- COLE, W., and KNAPP, M. The Kenny treatment of infantile paralysis: a preliminary report. *J.A.M.A.*, 116 : 2577, 1941.
- COLE, W., POHL, J. F., and KNAPP, M. E. The Kenny Method of Treatment for Infantile Paralysis. *Pub. No. 40.* New York, National Foundation for Infantile Paralysis, Inc., 1942.
- DALY, M. I., GREENBAUM, J., REILLY, E. T., WEISS, A. M., and STIMSON, P. M. Treatment of poliomyelitis. *J.A.M.A.*, 118 : 1433, 1942.
- FISCHER, E. Effect of faradic and galvanic stimulation upon course of atrophy in denervated skeletal muscles. *Am. J. Physiol.*, 127 : 605, 1939.
- FRAENKEL, H. S. The Treatment of Tabetic Ataxia by Means of Systematic Exercise. Translated by L. Freyberger. Philadelphia, P. Blakiston, 1902.
- GRODINS, F. S., OSBORNE, S. L., IVY, A. C. Present status of electrical stimulation of denervated muscle. *Arch. Phys. Therapy*, 23 : 729-733, 1942.
- GRODINS, F. S., OSBORNE, S. L., JOHNSON, F. R., ARANA, S., and IVY, A. C. Effect of appropriate electric stimulation on atrophy of denervated skeletal muscles in the rat. *Am. J. Physiol.*, 142 : 222, 1944.
- HANSSON, K. G. Hydrogymnastics in the physical therapy of poliomyelitis. *M. Times*, New York, 66 : 66-68, 1938.
- HARRY. Quoted by Hansson. After treatment of poliomyelitis. *J.A.M.A.*, 113 : 32-35, 1939.
- JACOBSON, E. The Technic of Progressive Relaxation. In Principles and Practice of Physical Therapy. Hagerstown, Maryland, Prior, 1932, Vol. III, Chap. 18.
- JOSTES, F. A. Neck pain. *J.A.M.A.*, 118 : 353, 1942.
- KENNY, E. M. The Treatment of Infantile Paralysis in the Acute Stage. St. Paul, Minnesota, Bruce Pub. Co., 1941.
- LEGG, A. T. Physical Therapy in Infantile Paralysis. In Principles and Practice of Physical Therapy. Hagerstown, Maryland, Prior, 1932, Vol. II, Chap. 8.
- LOVETT, R. W. The Treatment of Infantile Paralysis. Philadelphia, Blakiston, 1917.

sive movements may improve the circulatory status. If general body massage proves too great a strain, this procedure may be restricted to the extremities. At first the passive movements are applied evenly and slowly to the peripheral joints of the extremities. Nylin suggests that each treatment be conducted as follows: Two or three respirations, massage to one leg, passive movement of toes and ankle of this leg, two or three respirations, pause of one or two minutes. This is repeated with the other leg and then with each arm. Following this, effleurage is applied to the trunk. Three or four deep respirations conclude the treatment. As the patient's cardiac status improves, the extremities are massaged more vigorously with kneading movements, and the hip and shoulder are included in the passive exercises.

The range of motion in the joints is gradually increased until with evidence of an increase in cardiac reserve, active exercises can be given. An increase in pulse rate and blood pressure persisting for more than two or three minutes after exercise indicates that the exertion has been too strenuous. So also does the occurrence of dyspnea, palpitation, precordial pain, or arrhythmia. As the patient's tolerance increases, the exercise should be made progressively more difficult. Exercises are first given with the patient lying on his back, then in the sitting position, and finally in the standing position. Exercises should be conducted during the daytime, and at least one hour should elapse after a meal before they are undertaken.

*Schott Exercises* Resistive exercises may be started as soon as increase in cardiac reserve power warrants it. Such exercises were recommended by Schott to strengthen the heart muscles. Schott maintained that movements without design weaken the heart while those with design strengthen it. The resistance offered to the muscular activities of the patient must be so regulated that it causes but little exertion and no fatigue. An outline of the Schott exercises as administered to patients with chronic disease is as follows:

- 1 The arms are to be raised slowly, outward from the side until they are on a level with the shoulder. After a pause they should be lowered slowly.
- 2 The body should be inclined sideways as much as possible toward the right, and then to the left.
- 3 One leg should be extended as far as possible sideways from the body, the patient steadying himself by holding on to a chair. The leg is then dropped back. The same movements are repeated with the other leg.
- 4 The arms are raised in front of the body to a level with the shoulder and then lowered.
- 5 The hands are rested on the hips, the body is bent forward as far as possible and then raised to the upright position.

# CHAPTER XVIII

## CARDIOVASCULAR DISEASES

### CARDIAC DISEASE

#### USE OF EXERCISE

**W**ILLIAMSON SAYS: "IN PLACE OF THE PRESENT PRACTICE of restrictive activities, I would advocate that, as soon as we are satisfied that active infection has ceased, we should embark upon a course of intelligent exercise. Our object is to obtain as full development as possible of the myocardium." There is no doubt that measured and regulated bodily activity has positive physical and psychic benefits. Heart disease is not produced by physical exertion.

The American Heart Association classifies patients with organic heart disease on the basis of the functional capacity of the heart:

*Class I:* Persons with organic heart disease who are able to perform ordinary physical activity without discomfort.

*Class II:* Persons with organic heart disease who are unable to perform ordinary physical activity without discomfort. These patients are subdivided into two groups: (a) Those whose physical activity is slightly limited; (b) Those whose physical activity is greatly limited.

*Class III:* Persons with heart disease who have symptoms or signs of heart failure while at rest.

*Class IV:* Persons with possible heart disease.

*Class V:* Persons without heart disease who should be kept under observation because of the presence or history of an etiological factor which might predispose to heart disease.

The type of physical therapy to be employed in cardiac disease must be governed by the cardiac status. When a patient has symptoms of decompensation while lying in bed it is essential that he have complete rest; he should be spared the necessity of making any movement as far as possible. As diminution in the degree of heart failure takes place, mild effleurage and pas-

are undertaken, for instance, braid weaving with the frame suspended over the bed. Frame or cardboard weaving can be used as a preliminary to loom weaving when the patient is able to be up and about. Leather tooling, basketry with raffia, and needlecrafts are common forms of occupational therapy.

*Terrain Cure* The chronic cardiac patient who is able to carry on restricted, customary daily activities may be benefited by carefully graded exercises such as those advised by Stokes and Oertel. The terrain, or walking cure, was introduced by Sir William Stokes. He was the first to call attention to the fact that rational gymnastics can produce hypertrophic changes and strengthen the heart. His cure consisted of prescribing a definite dose of walking along paths of various inclines, or on level ground. His principle of treatment was forgotten for about fifty years until Oertel reintroduced it. In general, the following rules were adopted in giving the treatment:

1. The patient must walk every day at two different periods over the ground prescribed as far as he can without fatigue. Between the walking periods, the patient is required to rest.

2. The patient must avoid all temporary overstrain of the heart. This can be controlled by limiting the time or speed, the distance to be traveled, and by being sure he is not out of breath as a result of the walk.

3. The walk should be taken early in the day and all tiring movements avoided at the end of the day.

These exercises include graded walks such as are to be found at some of the spas, for example, Saratoga Springs and Watkins Glen in New York, and Hot Springs in Arkansas. The walks are given in a series, usually there are twenty two, beginning with a 3 per cent grade for a stretch one twelfth mile in length and progressing gradually to a two mile walk with a 15 per cent grade. A modification of these hill-climbing exercises is found at Saratoga Springs in the so-called "therapeutic golf-course," where no grade is over 4 degrees and the length of the holes was carefully planned. The schedule for the distance and grade to be traversed in these walks should not be arranged in advance, as the capacity of the cardiac patient for work may fluctuate daily. Such variations may result from changes in the extent of the cardiovascular involvement, changes in weather, emotional disturbances, insomnia, and gastro-intestinal upsets.

*Exercise Tests* The amount of effort which the patient can expend must be guided by his sensations. Several tests have been proposed to measure the cardiac capacity. Among them is the two-step exercise test of Master and Oppenheimer in which the effect of a measured amount of exercise on the



6. One leg is raised with the knee as straight forward as possible, then brought back. This movement is repeated with the other leg.

7. With the hands on the hips, the body is twisted round as far as possible to the right, and then again to the left.

8. With the hands resting on a chair and the back stiff and straight, each leg is raised as far backwards as possible; first one and then the other.

9. The arms are extended and the fists supinated. The arms are then extended outward, next inward.

10. Each knee is first raised as close to the body as possible and then the leg is extended.

11. This movement is the same as number 9, but with the fists pronated.

12. Each leg is bent backward from the knee, and then straightened.

13. Each arm is bent and straightened from the elbow.

14. The arms are brought from the sides forward and upward, then downward and back as far as they will go, while the elbows and the hands are held straight.

15. The arms are elevated to the shoulder level and then bent from the elbows inward and again extended.

16. With the arms in front at the level of the shoulder, and the hands stretched, the arms are opened out sideways and then brought together.

17. The arms are bent from the elbow outward and extended.

Thorne described these exercises in detail and called attention to the following rules to be observed in their conduct:

“Each movement is to be performed slowly and evenly, that is, at a uniform rate. No movement is to be repeated twice in succession in the same limb or group of muscles. Each single or combined movement is to be followed by an interval of rest. The movements are not to be allowed to accelerate the patient’s breathing, and the operator must watch the face for the slightest indications of (1) dilatation of the alae nasi; (2) drawing of the corners of the mouth; (3) duskiness or pallor of the cheeks and lips; (4) yawning; (5) sweating; (6) palpitation.”

Should these symptoms occur, the exercise must be promptly discontinued. Resistive exercises are contraindicated in advanced arteriosclerosis, where there is danger of causing hemorrhage; in the presence of fever; angina pectoris; and in conditions in which they are not well tolerated, as in physical and mental exhaustion.

Stroud suggests that when patients with organic heart disease are able to carry on diminished physical activity, they should be given vocational training to fit them for work which is adapted to their disability. When the patient is confined to bed, only those activities which can be performed there

are undertaken, for instance, braid weaving with the frame suspended over the bed. Frame or cardboard weaving can be used as a preliminary to loom weaving when the patient is able to be up and about. Leather tooling, basketry with raffia, and needlecrafts are common forms of occupational therapy.

*Terrain Cure* The chronic cardiac patient who is able to carry on restricted, customary daily activities may be benefited by carefully graded exercises such as those advised by Stokes and Oertel. The terrain, or walking cure, was introduced by Sir William Stokes. He was the first to call attention to the fact that rational gymnastics can produce hypertrophic changes and strengthen the heart. His cure consisted of prescribing a definite dose of walking along paths of various inclines, or on level ground. His principle of treatment was forgotten for about fifty years until Oertel reintroduced it. In general, the following rules were adopted in giving the treatment:

- 1 The patient must walk every day at two different periods over the ground prescribed as far as he can without fatigue. Between the walking periods, the patient is required to rest.

- 2 The patient must avoid all temporary overstrain of the heart. This can be controlled by limiting the time or speed, the distance to be traveled, and by being sure he is not out of breath as a result of the walk.

- 3 The walk should be taken early in the day and all tiring movements avoided at the end of the day.

These exercises include graded walks such as are to be found at some of the spas, for example, Saratoga Springs and Watkins Glen in New York, and Hot Springs in Arkansas. The walks are given in a series, usually there are twenty-two, beginning with a 3 per cent grade for a stretch one-twelfth mile in length and progressing gradually to a two-mile walk with a 15 per cent grade. A modification of these hill-climbing exercises is found at Saratoga Springs in the so-called "therapeutic golf-course," where no grade is over 4 degrees and the length of the holes was carefully planned. The schedule for the distance and grade to be traversed in these walks should not be arranged in advance, as the capacity of the cardiac patient for work may fluctuate daily. Such variations may result from changes in the extent of the cardiovascular involvement, changes in weather, emotional disturbances, insomnia, and gastro-intestinal upsets.

*Exercise Tests* The amount of effort which the patient can expend must be guided by his sensations. Several tests have been proposed to measure the cardiac capacity. Among them is the two-step exercise test of Master and Oppenheimer in which the effect of a measured amount of exercise on the

blood pressure and pulse rate is recorded. Lewis stated that breathlessness is the earliest and most valuable sign suggesting loss of cardiac reserve power. Tice declared that "if strenuous exercise can be indulged in without evidence of dyspnea there is no reason for regarding the lesion with any immediate concern. The outlook in any case is in exact proportion to the reaction from exercise." The expenditure of physical energy during a game should be in proportion to the cardiac strength; only those games which are characterized by alternating periods of work and rest are advised, for instance, croquet, archery, and golf.

#### SPA AND HYDROTHERAPY

Spa therapy is beneficial for patients with chronic cardiac disease, and facilities should exist to permit the patient of small means to take a vacation at a spa. Acutely ill patients are better off in their home surroundings. Wallace has described the advantages of spas: "There are certain features which these resorts should have in common, regardless of their mineral springs, in order to serve the patient best. Such features are based on hygiene in its broadest sense and should include competent medical supervision, a proper dietary, systematic rest, regulated exercise, a proper knowledge of the reserve the patient possesses so that he can live sanely within that reserve, and proper physical therapy, hydrotherapy and electrotherapy given by competent attendants, the whole to be so planned and regulated that the patient's day is entirely occupied. Psychic elevation of the morale and the development of a proper philosophy toward the disease from which he suffers should be additional features the spa should see accomplished for the patient." The physical advantages of a spa include climatic, as well as hydrotherapeutic factors. Absence of strong winds and of fog, cool nights, and other favorable climatic conditions are to be found at spas.

*Hydrostatic Effects.* The hydrotherapeutic use of water includes not only considerations of the temperature of the water and its carbon dioxide content, but also its hydrostatic effect. The return of venous blood to the heart is aided by the pressure of water on the veins. Also, the weight of the water on the abdomen working in conjunction with the contraction of the diaphragm helps to force blood into the thorax. Hill states that the accompanying rise in pulmonary pressure leads to a deepening of the respirations and an increase in the alveolar carbon dioxide tension. He believes that the sense of oppression sometimes felt when entering a deep bath is probably due to a combination of increased respiratory excursion and temporary dilatation of

the right side of the heart from accelerated venous return. The weight of water against the chest increases the thoracic pressure and therefore nullifies to some extent the effects of the increase of the abdominal pressure. Therefore in the presence of circulatory disease, it may be necessary to give only half a bath with water not extending above the abdomen.

*Carbon Dioxide Baths* The technique for the application of carbon dioxide baths and the physiological alterations which they produce are described in Chapter II. The indications for the use of carbon dioxide baths are circulatory disorders of a mild or moderate degree, such as congenital or acquired valvular lesions, chronic pericarditis, cardiac insufficiency secondary to emphysema, functional arrhythmia, tachycardia, conditions due to peripheral vascular spasm, like acrocyanosis or Reynaud's disease, and conditions of general as well as cardiac debility, frequently associated with low blood pressure which commonly follow influenza and other infections. Patients with hypotension not due to organic causes such as tuberculosis or Addison's disease, are benefited by carbon dioxide baths and other forms of spa treatment. For hypotension the baths are administered with full aeration and at a relatively low temperature. In addition, spinal douches, massage, and exercise are given with due care to avoid fatigue.

Pierach cautions that carbon dioxide baths must be used carefully in mitral stenosis, since they increase the return circulation to the heart. He notes that this type of bath impedes respiration and decreases air reserves. The coronary circulation is reduced, the frequency of the pulse decreased, and the minute volume increased. Sudden immersion into a carbon dioxide bath necessitates rapid adaptation of cardiac capacity, and therefore it is dangerous for patients who have angina pectoris or coronary sclerosis. Other contraindications include decompensation with loss of cardiac reserve, recent cardiac infarction or embolism, recent inflammatory processes of the heart, aortic aneurysm, hypertension of renal origin, thrombosis, thrombophlebitis of the extremities, and severe exophthalmic goiter.

In the treatment of cardiac conditions three-quarter and half baths are frequently used because they have a milder effect on the venous circulation and respiration. In some spas, partial carbon dioxide baths in which the arms and legs are immersed in a warm spray for a few minutes are given to patients with relatively severe cardiac disease. Two carbon dioxide baths can be given during the week for a period of at least four weeks. Partial carbon dioxide baths are also administered for disturbances of peripheral circulation.

*Influence of Temperature.* The effect of the temperature of water is important. Ninety-five degrees Fahrenheit is an indifferent temperature. Temperatures of 90° F. and less increase the peripheral resistance and so slow the heart's action and increase its work. Warm baths of 100.4° to 106° F. increase the cardiac frequency and cause a lowering in blood pressure resulting from peripheral vasodilatation. Because there occurs no increase in the quantity of blood going to the heart muscles in warm baths, these baths are contraindicated in the presence of coronary sclerosis. Hot full baths are used only when the heart is perfectly healthy. Partial baths with increasing temperature have been recommended by Hauffe in the treatment of hypertension, angina pectoris and decompensated valvular disease. These are described in the chapter on "Hydrotherapy." Groedel employs ice bags in tachycardia and cardiac irregularities. Before the development of techniques such as the intravenous injection of digitalis, pulmonary edema was treated by immersing the patient's feet in hot water. Following such an application, Groedel has observed the edema disappear within two or three minutes.

*Cardiac Neuroses.* Patients suffering from cardiac neuroses have improved under spa therapy. According to Connor, cardiac neuroses have developed in persons who have been told by a physician or life insurance examiner that their hearts show some abnormality, or who have been unduly affected by some dramatic case of heart disease among relatives or friends, or who have experienced some symptoms such as a sudden skip or twinge of pain, palpitation or dyspnea after exertion. Symptoms of the latter type occur during convalescence; after grippe; from excessive use of tobacco and coffee; or as a result of profound and protracted emotional disturbances, for example, the irritable heart of soldiers. Spa therapy provides these patients with a new environment, a period of rest, and treatments such as hydrotherapy, massage, mechanotherapy, and exercise.

#### ENDOCARDITIS AND RHEUMATIC CARDITIS

Physically induced fever may be a life-saving measure in some cases of gonorrhoeal endocarditis. A few recoveries have occurred in subacute bacterial endocarditis following the combined use of fever and chemotherapy. Children with rheumatic carditis respond well to a warm environment. A winter sojourn in a subtropical climate is very helpful. Induction of systemic elevation of temperature by physical means usually causes a definite though temporary improvement in these patients.

## ANGINA PECTORIS

It is difficult to determine whether short wave diathermy has any special value in the treatment of angina pectoris because spontaneous remissions occur in this disease and because rest and other measures are applied concurrently. However, numerous authors are of the opinion that the short wave current is of value in angina pectoris. Among these is Meyer whose technique is as follows. An apparatus of medium power, giving wavelengths of from 6 to 16 meters is used. One electrode, 10 to 12 cm in diameter, is applied over the region over the heart. The other is placed along the vertebral column either over the area of the fourth dorsal vertebra or on the left side of the neck at the level of the stellate ganglion. A series of eight to twelve treatments, each lasting from eight to fifteen minutes, are administered every second day. The systolic blood pressure is observed every two minutes. It should drop from 10 to 30 mm Hg during the treatment. If it rises continually, an attack of angina threatens and the current should be discontinued completely or reapplied at weaker intensity. While Siegen considers this technique the method of choice in heart diseases characterized by anginoid attacks, he cautions that the short wave current should not be administered without thorough medical supervision because of the possibility of severe attacks occurring during its application. Groedel has not observed any benefit from the use of the short wave or conventional diathermy currents in angina pectoris. He prefers conductive heating by means of hot water bags, hot compresses, or turpentine stupes placed on the chest in the region of the heart.

## PERIPHERAL VASCULAR DISEASE

Physical procedures alleviate the functional symptoms in peripheral vascular disease. While they do not cause the disappearance of the causative factors, they frequently arrest the progress of the local vascular disease and bring about sufficient improvement to permit restoration of the function of the involved extremities.

## USE OF HEAT

For many years physical measures have been employed in the treatment of thromboangiitis obliterans and arteriosclerosis. The inadequate peripheral circulation in these diseases demands circulation stimulating measures.

Heating hoods (so-called "bakers"), hot soaks, hot packs, and paraffin baths have been of great value in many cases and of little benefit in others. To be

effective, the application of these heating procedures must be guided by a knowledge of heat dosage. The optimum amount of heat which can be applied must not be large enough to activate unfavorable changes in tissue tensions and too great an increase in the local metabolic requirements. This is particularly true when the extent of the collateral blood bed and the capacity for vasodilatation are limited by disease. In some instances, better results are achieved by the abstraction of heat than by its application. Thus, in the presence of extensive embolization of the blood vessels of the lower extremity, I have observed that the exposure of the extremity to air chilled to a temperature of 40° F. retarded the development of gangrene and caused the cessation of pain which could not be relieved by large doses of opiates. Clinical and experimental studies indicate that it is best to avoid heating extremities with impaired circulation and threatened gangrene.

Starr found that the optimum temperature for patients suffering from peripheral vascular disease was usually from 92 to 95° F. A leg cradle containing a heating element and equipped with a thermostat permits continuous application of an even temperature. Comfortable temperatures within the cradle vary from 75 to 95° F. Although not as satisfactory as the heating element with thermostatic control, a forty or sixty watt lamp placed inside the cradle may be found adequate to maintain such temperatures. The cradle may be used continuously for twenty-four hours, or if the patient is ambulatory, only at night. Of all physical measures readily available for the treatment of peripheral vascular disease the thermostatically controlled heating hood is probably the most valuable (Fig. 49).

Conductive heating can also be carried out by means of leg baths with water temperatures at about 95° F. These "soaks" may be administered for thirty minutes once or twice a day. They cannot be used for as prolonged periods as can the thermostatically controlled foot cradle because they cause maceration of tissues. When there are open wounds, a relatively isotonic solution (two teaspoonfuls of salt to each quart of water) makes this treatment more agreeable. So also may the addition of boric acid or magnesium sulphate. Whirlpool baths with their mild massage and thermal effects are valuable forms of treatment. Contrast leg baths should be used with care to avoid extremes of temperature (Fig. 19).

When heating is applied with lamps and high frequency currents the danger of causing thermal damage in tissues whose blood supply is interfered with must be kept in mind. An increase in pain or the development of or increase in cyanosis of the treated part calls for cessation of the treatment or a reduction in the quantity of energy used. The diathermy current may

be applied in various ways. One electrode may be placed on the lower back and the other on the plantar surface of the foot or, particularly in advanced cases, over the area of the calf muscles. Or the electrodes may be placed on

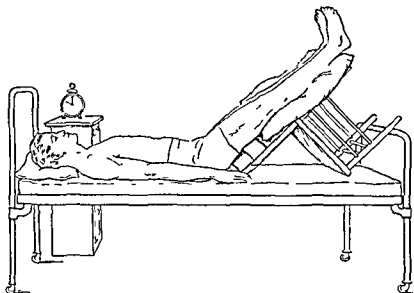

FIG 279 Buerger exercises *Ponnon A* Legs held elevated

the anterior aspect of the thigh and on the calf. The short wave currents may be applied in a similar manner or by means of flexible cable electrodes. High frequency currents appear to be more effective in arteriosclerosis than in thrombo angitis obliterans. This may be due to the involvement of the veins in the latter disease.

#### EXERCISES

Exercise 15 is of value in the treatment of thrombo angitis obliterans. Buerger developed a series of motions designed to increase the circulation. In the first position, the patient lies supine and the affected extremity is elevated between 45 and 60 degrees above the horizontal for the minimum time required to produce ischemia (thirty seconds to three minutes). The back of a chair placed on the bed can be used to maintain the elevation of the legs. Kaiser designed an exercise board to facilitate holding the limb in this position. This board measures 11 by 40 inches, and is hinged to permit an angle of from 45 to 60 degrees. A lower board is fitted with cleats to support a tongue attached to the upper board. The entire device is collapsible. The upper end of the board is covered with a pillow or blanket to prevent pressure from a sharp edge (Fig 279).

In the second position, the patient sits on the edge of the bed with his



legs hanging down until one minute after the appearance of reactionary rubor (2 to 5 minutes). Allen suggests the active movements of the ankle be added while the legs are in the pendant position: flexion, extension, ex-

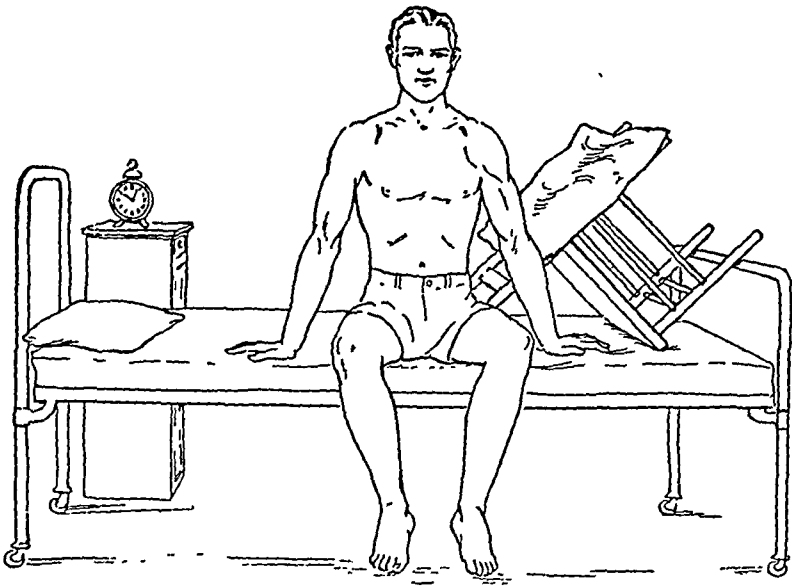

FIG. 280. Buerger exercises. *Position B*: Patient sitting on edge of bed.

ternal rotation, internal rotation, abduction and adduction (Fig. 280).

In the third position, the patient lies flat on his back with his legs held horizontally for a period of about five minutes. While in this position, mild heating may be applied. About ten minutes are usually required for the performance of the entire cycle of three positions. At first, the exercises are performed for about one-half hour which allows time for three repetitions of the cycle. If the patient's condition improves, the number of cycles may be increased to six or seven. Three such treatments are administered daily (Fig. 281).

Sanders devised an apparatus which automatically and continuously rocks the bed through an arc of 60 degrees at a slow, regular rate. Patients soon learn to lie and sleep on this device without experiencing any discomfort. It is of particular value for those patients in whom the effort required for the performance of the Buerger exercises is too great. In many patients it relieves pain. It may be used either continuously or for intermittent periods during the day, by itself or in conjunction with other measures. Because many patients with peripheral vascular disease feel better when their involved legs are held in a dependent position, Starr has suggested a modification of the ordinary bed. This consists of a box placed at an angle in

the lower portion of a bed in which the spring has been shortened or removed. When the back rest is down, the feet can be arranged to assume a position of about 30 degrees below horizontal. When the back rest is elevated, the

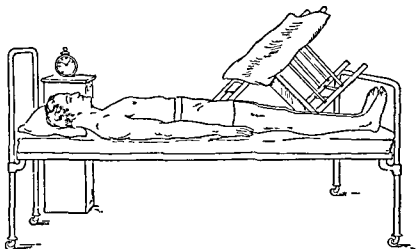

FIG 281 Buerger exercises *Pontoon C* Patient lying flat on bed

angle can be increased to 45 degrees. Patients may be relieved of pain when their legs are placed in the dependent position. It should not be employed in the presence of infections or edema.

#### ALTERNATING POSITIVE AND NEGATIVE PRESSURES

The circulation in the extremities may be encouraged by alternately diminishing and increasing the surrounding pressure. The ideal mechanism for this purpose would be one which would decrease the atmospheric pressure surrounding the leg as the blood courses through the vessels directly after the systolic contraction of the heart, and increase the pressure as the venous return flow starts. A machine for such a purpose would be too intricate and expensive to be practical. The apparatus now available produces alternate suction and pressure by means of a pump. The leg to be treated is inserted into a boot made of metal, wood, glass or plastic material which is connected to the pump by a hose. In order to make the device air tight, a cuff is placed around the leg, this must be tight enough to maintain the increased and reduced pressures. The constriction produced by the cuff causes some embarrassment to the venous circulation and, to a lesser extent, to the arterial circulation (Fig 282). In the Landis technique the alternations occur quickly and vary from a negative pressure of about 120 mm Hg which is held for twenty five seconds to a positive pressure of 80 mm Hg for five seconds. The technique which is employed by Herrmann consists in using

legs hanging down until one minute after the appearance of reactionary rubor (2 to 5 minutes). Allen suggests the active movements of the ankle be added while the legs are in the pendant position: flexion, extension, ex-

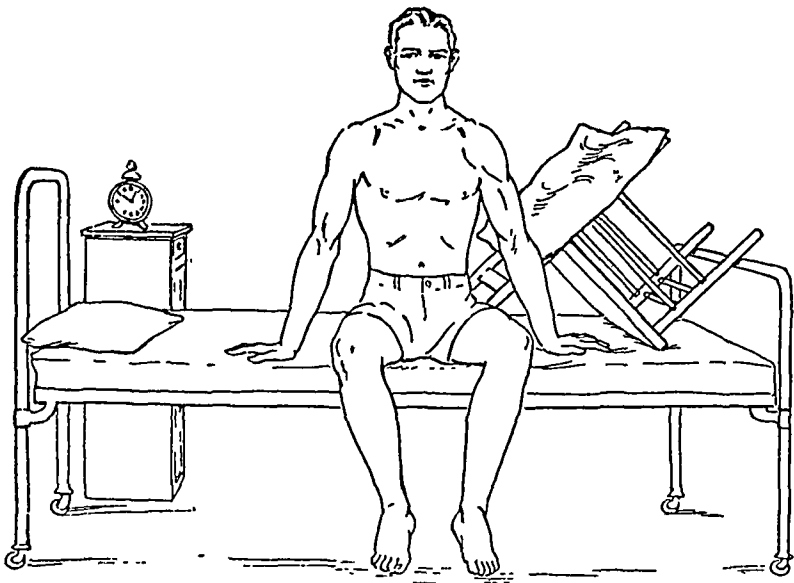

FIG. 280. Buerger exercises. *Position B*: Patient sitting on edge of bed.

ternal rotation, internal rotation, abduction and adduction (Fig. 280).

In the third position, the patient lies flat on his back with his legs held horizontally for a period of about five minutes. While in this position, mild heating may be applied. About ten minutes are usually required for the performance of the entire cycle of three positions. At first, the exercises are performed for about one-half hour which allows time for three repetitions of the cycle. If the patient's condition improves, the number of cycles may be increased to six or seven. Three such treatments are administered daily (Fig. 281).

Sanders devised an apparatus which automatically and continuously rocks the bed through an arc of 60 degrees at a slow, regular rate. Patients soon learn to lie and sleep on this device without experiencing any discomfort. It is of particular value for those patients in whom the effort required for the performance of the Buerger exercises is too great. In many patients it relieves pain. It may be used either continuously or for intermittent periods during the day, by itself or in conjunction with other measures. Because many patients with peripheral vascular disease feel better when their involved legs are held in a dependent position, Starr has suggested a modification of the ordinary bed. This consists of a box placed at an angle in

the next four days. On the seventh day, it is given every other hour from 9 00 A.M. to 10 00 P.M. Treatment is continued for approximately one month. If, during the treatment, the patient is able to tolerate it, the pressure

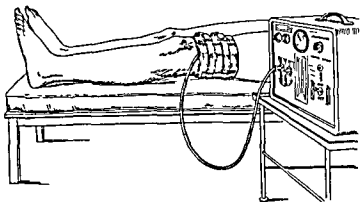

FIG 283 Apparatus for application of intermittent occlusion

is increased to 80 mm Hg. If edema develops at any time the treatment should be discontinued for twenty four hours. In cases of arterial impairment with open lesions the pressure is reduced and the duration of the treatment is shortened. In the presence of indolent ulcers or gangrene, 30 mm Hg pressure is applied for one, two, or three minute intervals, and for one or two hours a day. During treatments a lamp is used to hold the temperature of the air surrounding the legs at about 90 to 100° F.

Daily heating by means of the short wave current may be used simultaneously with the intermittent pressure. The current is applied with low intensity for about fifteen minutes. Electrodes are placed above the knee and on the plantar surface of the foot. For ambulatory patients, the short wave current can be administered for about twenty minutes while the intermittent venous pressure is applied at 60 mm Hg pressure for a period of one hour with intervals of one minute on and one minute off.

The intermittent venous occlusion technique has proved of value in healing of ulcers. Its use is contraindicated in infected gangrenous lesions. Judging from our temperature studies as well as from our clinical results, this procedure increases the circulation of the skin but not of the musculature of the leg (Fig 283).

#### MASSAGE

Massage, if administered cautiously, is a helpful measure in the treatment of peripheral vascular disease. It should not be applied when lymphangitis, phlebitis, acute arterial obstruction, acute embolus or thrombosis, and severe

80 mm. Hg of negative pressure for twelve seconds and 20 mm. Hg of positive pressure for three seconds. The changes from one phase to the other are made gradually. This latter technique is the one more commonly used today.

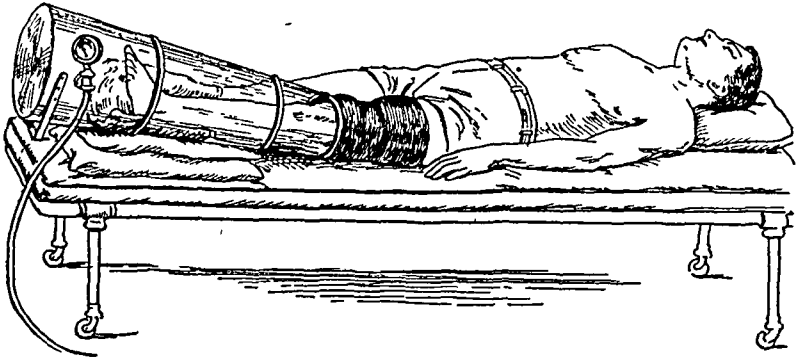

FIG. 282. Apparatus for alternate positive and negative pressure.

The most striking therapeutic improvements produced by these devices have been reported in cases of sudden occlusion due to emboli. Good results have also been obtained in the treatment of frostbite. The procedure also appears to be of value in the treatment of arteriosclerosis, particularly when the major involvement is in the large and medium-sized vessels. Claims have been made that this treatment brings about improvement in claudication, the relief of rest pain, and the healing of ulcers and gangrene. The results obtained in the treatment of thrombo-angiitis are still indefinite. This apparatus should not be used when there is evidence of acute phlebitis, abscess formation, or spreading thrombosis and infection.

#### VENOUS COMPRESSION

Harpuder obtained good results in the treatment of indolent ulcerations occurring in peripheral vascular disease through venous compression effected by placing a rubber bandage four inches wide around the leg. This was applied daily above the knee with very little pressure, and for periods increasing from two to eight hours. Harpuder found that this method of simple compression is, in many cases, not less effective than intermittent venous compression. Collens introduced the technique of intermittent venous occlusion, which is based on the continuous production of an alternating Bier congestive hyperemia and Lewis reactive hyperemia. A pressure of 60 mm. Hg is applied in a cuff encircling the leg. This pressure is held for two minutes and then released for two minutes. The treatment is given continuously day and night for the first two days, then twelve hours a day for

stasis should be avoided. In the acute stage, the treatment they follow is elevation of the leg to 30 degrees, continuous hot packs applied when the temperature has been normal for at least three days and tenderness and swell-



FIG. 284 Artificial carbon dioxide bath applied to the lower extremities. The technique is the same as that described for the systemic artificial carbon dioxide bath. The insert indicates hyperemia produced with sharp line of demarcation.

ing have disappeared. The leg is then lowered for two days. The patient is allowed up ten to sixteen days after the onset of the thrombophlebitis. The prevention of secondary varices, edema, and ulceration is accomplished by leg supports. For this purpose, they prefer first a solid rubber bandage and second a heavy elastic stocking. The support is applied from the toes to the knee before the patient gets out of bed, rewrapped twice during the day and removed at bedtime. For a period of one or two months the leg should be elevated slightly when sleeping or sitting. The bandage may be discarded when swelling no longer appears—usually in three to twelve months.

Acute phlebitis is treated by elevation of the legs in bed and application of cold compresses. In the later stages, daily iontophoresis with acetyl beta-methyl choline chloride may hasten subsidence of the inflammation. Indolent ulcers which occur in the presence of varicose veins can be treated by compression bandages, ultraviolet radiation, whirlpool baths, and steam applied directly to the ulcer. These measures can be used in addition to the injection treatment for the varicose veins themselves.

obstructive arterial disease with gangrene are present. The dry skin should be softened by a grease or ointment before it is massaged. In bed-ridden patients particular attention should be paid to the region of the heel as well as to the lower back in an effort to prevent the development of ulcers.

#### IONTOPHORESIS

The vasodilating effect of histamine and acetyl-beta-methyl choline chloride iontophoresis may be used to advantage in peripheral vascular disease. A large dispersive pad is placed on the back and attached to the negative pole of the galvanic machine. Asbestos paper soaked with the special solution is placed around the involved extremity and connected to the positive pole by means of a metal strip making contact with the paper. Histamine is used in a 1:1000 solution; acetyl-beta-methyl choline chloride in a 0.1 to 0.5 per cent aqueous solution. A current of 15 to 25 milliamperes is applied for about thirty minutes. It is a question whether the therapeutic results achieved by this technique in cases of arteriosclerosis and thromboangiitis obliterans cannot be secured more simply by other methods of dilating the blood vessels of the skin. Harpuder has found local application of artificial carbon dioxide baths a valuable measure in the treatment of inadequate circulation of the extremities due to arteriosclerotic changes (Fig. 284).

*Thrombophlebitis.* Sokolov and Meyers obtained good results in 18 out of 19 patients suffering from thrombophlebitis by use of iontophoresis with a 0.1 per cent solution of acetyl-beta-methyl choline chloride. Treatments were given daily for forty-five minutes for the first six to ten days and then two or three times weekly. The side effects noted were local diaphoresis, flushing, salivation, and increased intestinal peristalsis. The most striking improvement occurred in recent postoperative cases. When the disease had been present for a number of years, improvement occurred more slowly and more treatments were required to effect it. Chronic leg ulcers were healed by this procedure. In the application of the iontophoresis the ulcerated area itself was covered with a thin piece of rubber sheeting to prevent concentration of current in the region of the ulcer with consequent pain and tissue damage.

Barker and Counselor discuss the prevention and treatment of postoperative thrombophlebitis. They recommend elevation and exercise of the limbs and the use of thyroid extract as preventive treatment. They believe that an interval of at least six months should pass before an operation is performed on a patient who has had an acute attack of thrombophlebitis. They advise that a patient with thrombophlebitis should be kept in bed for the shortest possible time and that any position or tight binders which may cause venous

- HAUFFE, G A Die physiologische Wirkung der verschiedenen Reizstaerken  
*Neue deutsche Klin*, 5 192, 1930
- LANDIS, E M, and GIBBON, J H Effects of alternate suction and pressure on  
circulation in the lower extremities *Proc Soc Exper Biol & Med*, 30 593,  
1933
- LEWIS, (SIR) THOMAS Soldier's Heart and the Effort Syndrome New York,  
Hoebner, 1918
- MASTER, A M, and OPPENHEIMER, E T Simple exercise tolerance test for circu-  
latory efficiency *Am J M Sc*, 177 223-243, 1929
- MEYER, J Referate u Mitteil Internat Kongress f Kurzwellen Vienna, Bruder  
Hollinek, 1937
- NYLIN, J B Physical exercise in cardiac conditions *M Rec*, 149 373-376, 1939
- PIERACH, A Treatment of chronic circulatory weakness caused by conditions of  
the heart *Fortschr d Therap*, 16 163-177, 1940
- REID, M R, and HERRMANN, L G Treatment of obliterative vascular diseases  
by means of intermittent negative pressure environment *J Med*, 14 200, 1933
- SANDERS, C E Cardiovascular and peripheral vascular disease Treatment by a  
motorized oscillating bed *JAMA*, 106 916, 1936
- SCHOTT, T On the treatment of chronic disorders of the heart *Boston M &  
S J*, 156 623, 1907
- SEIGEN, H Referate u Mitteil Internat Kongress f Kurzwellen Vienna, Bruder  
Hollinek, 1937
- SOKOLOV, R A, and MEYER, M P Treatment of deep thrombophlebitis and  
chronic leg ulcers with mecholyli iontophoresis *Am Heart J*, 17 316-324, 1939
- STARR, I A thermo regulated foot cradle for the treatment of peripheral vascular  
disease *Proc Soc Exper Biol & Med*, 29 166, 1931
- STOKES, W Cited by Stroud, W D Principles and Practice of Physical Therapy  
Hagerstown, Maryland, Prior, 1932, Vol I, Chap 13
- STROUD, W D, and COMSTOCK, C R Physical therapy in cardiovascular disease  
In Principles and Practice of Physical Therapy Hagerstown, Maryland, Prior,  
1932, Vol I, Chap 13
- TICE, F Practice of Medicine Hagerstown, Maryland, Prior, 1932
- THORNE, W B The Schott Methods of Treatment of Chronic Disorders of the  
Heart Philadelphia, Blakiston, 1902
- UNGLEY, C C, and BLACKWOOD, W Peripheral vasoneuropathy after chilling—  
'immersion foot and immersion hand' *Lancet*, 2 447, 1942
- WAKIM, K G, and GATCH, W D The effect of external temperature on shock  
*JAMA* 121 903, 1943
- WALLACE, A W The modern health resort An appraisal of its possibilities  
*JAMA*, 107 419, 1936
- WEBSTER, D R, WOOLHOUSE, F M, and JOHNSTON, J L Immersion foot  
*J Bone & Joint Surg*, 24 785, 1942



## FROSTBITE AND IMMERSION FOOT

Rapid thawing of frozen tissue will cause swelling and pain. Gradual thawing can be accomplished by the application of gentle warmth, which, according to Greene, should never be greater than that of the human body. Friction adequate to be effective causes trauma to the foot and should therefore be avoided. The involved area should be wrapped in cotton and held at rest. The patient should be removed to a moderately warm room and given hot food and drinks.

The changes occurring as a result of prolonged immersion of the feet in cold water, as in ship survivors who remain in small boats for long periods of time, have been described by Ungley and by Webster. The treatment they recommend includes strict asepsis, avoidance of trauma, and slow warming of the involved extremities. Massage should not be applied. Dry refrigeration appears to reduce tissue loss to a minimum. The feet should be cooled during the stage of hyperemia.

## SHOCK

Peripheral circulatory failure occurs in shock and is evidenced by a cold clammy skin, hemoconcentration and oligemia. Much experimental evidence has been gathered to show that the application of heat to the body of the animal in shock can be harmful, particularly if the rectal temperature is normal or above normal. Wakim and Gatch advise that the best thing to do with persons in shock is to avoid exposing them to cold by wrapping them in blankets but that too much heat is contraindicated and the wholesale use of hot water bottles should be avoided. They found that cold and heat can be harmful to animals in shock and that an external temperature in the neighborhood of that of the mammalian body seems to be optimal for survival.

## REFERENCES

- BARKER, N. W., and COUNSELOR, V. S. Prevention and treatment of post-operative thrombophlebitis. *Am. J. Obst. & Gynec.*, 37-44 : 644-651, 1939.
- BUERGER, L. *The Circulatory Disturbances of the Extremities*. Philadelphia, Saunders, 1924.
- COLLENS, W. S., and WILENSKY, N. D. *Peripheral Vascular Disease*. Springfield, Ill., Thomas, 1939.
- CONNOR, L. A. Psychic factor in cardiac disorders. *J.A.M.A.*, 94 : 447, 1930.
- GROEDEL, F. Personal communication. May, 1942.
- HARPUDER, K., and STEIN, I. Therapeutic value of passive hyperemia in peripheral vascular disease. *Arch. Phys. Therapy*, 20 : 9-15, 1939.

to differentiate between apical infections which are responsible for systemic disorders and those which are not Use of short wave diathermy as an auxiliary measure in the treatment of infections of the gum has been sug-

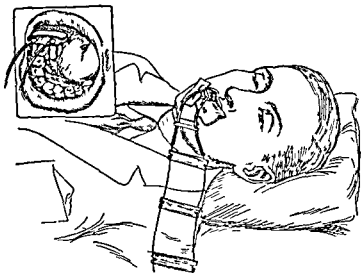

FIG 285 Short wave current applied to tooth The insert shows the position of the electrodes with relation to the region treated The cables are held away from the face by pads and separated from each other

gested by Allen Used surgically, the diathermy current affords a convenient method for destruction of both benign and malignant growths of the mouth (Fig 285)

Several years ago there was much enthusiasm concerning the effects of ultraviolet radiation in infections of the mouth The question of the value of this measure is still debated In the experience of some dentists, ultraviolet radiation of infected gums is helpful when used in conjunction with such procedures as scaling and injections of hydrogen peroxide Ultraviolet radiation is most conveniently applied through a quartz rod connected to a liquid cooled mercury vapor lamp (Kromayer) or to a "cold quartz" lamp Pressure of the applicator against the gums will cause superficial dehemitization and increase the possibility that the radiation will directly influence the tissues lying a short distance beneath the surface

#### SPASM OF THE ESOPHAGUS

Spasm of the esophagus has been treated by psychotherapy, dietotherapy, mechanotherapy, and thermotherapy The latter two are direct methods of attack Mechanotherapy, that is, insertion of dilating bougies, is attended with definite danger of esophageal rupture Heat may be applied in various

## CHAPTER XIX

# DISEASES OF THE DIGESTIVE SYSTEM

### THE ORAL CAVITY

**P**HYSICAL THERAPY PLAYS AN IMPORTANT PART IN THE care of structures of the mouth in health and disease. Massage by mastication of hard food substances and by use of the tooth brush helps to keep the gums in a healthy condition. Frequent and proper brushing of the teeth and gums becomes the more essential when the diet consists primarily of soft foods. The proper technique for brushing teeth has been fully described. Circulation in the gums may also be increased effectively by manual massage.

### ORAL INFECTIONS

Cold applications bring relief in painful swellings of the face. It is possible to lower the temperature of the mucous membrane lining the inner side of the cheek  $10^{\circ}$  F. by applying cold to the outer side of the cheek. In contrast, it does not appear possible to elevate the temperature of the mucous membrane by any form of conductive heating applied to the cheek. It is, however, possible to cause a slight elevation of the temperature of tissues by means of short wave diathermy. It would, therefore, appear logical to use the short wave current in infections of the mouth when surgical drainage exists or when there is the possibility of aborting the local infection. In the presence of pockets of pus, its use is contraindicated. There have been reports of good results obtained by the use of the short wave current in the treatment of localized infections in and about the teeth. However, further substantiation of its value is needed.

Gutzeit and Kuchlin have described an interesting procedure. They state that application of the short wave current to apical infections is followed by a rise in sedimentation rate within two to four hours, when the infection is the cause of systemic involvement. They suggest that this test may be used

this purpose Saidman and Meyer observed that the short wave current applied to the lumbar region had a rapid sedative effect on a number of painful gastric phenomena and particularly on pylorospasm

#### GASTRIC NEUROSES

To relieve gastric neuroses, the various forms of conductive or, better still, converse heating may be applied to the epigastric region

#### GASTRIC ATONY

To increase the tone not only of the abdomen but also of the viscera, Morgan suggests the use of diathermy, small, frequent meals, and exercise or calisthenics, daily Hydrotherapy is advised for its tonic effect Gastric lavage is recommended about three times weekly for three weeks, using 4 quarts of warm water containing 1 ounce of fluidextract of Quassia and 4 drachms of sodium bicarbonate The gastric musculature may be contracted by means of intragastric faradization Morgan's technique is as follows The negatively charged electrode is introduced into the stomach The positive electrode is moved over the region of the epigastrium The introduction of the gastric electrode is assisted by the drinking of 10 to 12 ounces of tepid water An intermittent current is applied for not longer than ten minutes every second or third day

#### HYPERCHLORHYDRIA

The treatment regime recommended includes dietary care, diminution in work and mental tension, exercise and cold sponge bathing every morning Pain is relieved by heat applied to the epigastrium

#### ACHYLIA GASTRICA

A stay at a spa with its relief of mental tension and removal from the scene of business activity, coupled with the tonic influence of hydrotherapy, exercise and massage is of value in achylia gastrica, as in other forms of gastric neuroses

#### GASTRITIS

Physical measures employed in the care of gastritis include gastric lavage, heat to the epigastrium by means of hot fomentations or diathermy, exercise, rest, heliotherapy, and ultraviolet radiation (Fig 286)

ways. I have elevated the temperature of the entire body in an effort to induce relaxation of esophageal spasm, but the temporary improvement secured in this way does not warrant employment of so vigorous a procedure. In my experience, the use of conversive energy and long and short wave diathermy, applied with electrodes placed on the chest anteriorly and posteriorly, has not been productive of good results. Others, including Kowarschik and Saidman, believe that it is possible to relieve esophageal spasm by the short wave current. Saidman places one electrode over the xyphoid cartilage and the other on the lateral aspect of the neck, and gives daily treatments with weak intensities, lasting from five to fifteen minutes. He states that if successful results are not obtained in three to six treatments, it is useless to continue. Kowarschik considers the short wave current particularly suitable for the care of hypertony of non-striated muscles, and therefore he uses it for esophageal spasm, cardiospasm, pylorospasm, intestinal spasm, spastic constipation, and spastic conditions of the gall bladder.

The intra-esophageal approach affords another method for the application of heat. Martha Brunner obtained excellent results in dysphagia and cardiospasm through the use of a special intra-esophageal diathermy electrode. This consists of a rubber tube to the lower portion of which a balloon made of a semipermeable membrane is attached. The collapsed balloon is introduced into the region of spasm, under fluoroscopic guidance if necessary. The balloon is then distended with salt solution. A wire running through the tube permits the diathermy current to be conveyed to the salt solution. The semipermeable membrane permits the current to be conducted to the esophageal mucosa. The other terminal of the diathermy machine is connected to two metal plates, one placed on the anterior and the other on the posterior aspect of the thorax. Brunner states that this special electrode is suitable for dilatation and also for primary atony. In this latter condition the faradic current is used instead of diathermy. The electrode is introduced only as far as the lower portion of the esophagus.

#### SPASM OF THE PYLORUS

For the relief of pylorospasm conductive heat is applied to the abdominal wall by means of poultices or hot water bags, and conversive heat by diathermy or the short wave current. Conductive heating can be administered directly with warm alkaline solutions in the form of gastric lavage. Morgan states that intragastric faradization has proved effective for restoring normal gastric tonus. He advises that massage and hydrotherapy also be used for

the administration of opium by mouth, by hypodermic, by suppository, or in a corn starch enema The latter consists of  $\frac{1}{2}$  drachm of tincture of opium in 4 ounces of thick corn starch water, heated to body temperature Heat to

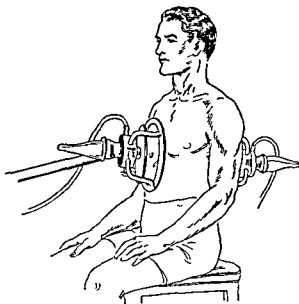

FIG 287 Short wave current applied to the region of the liver by means of rigid electrodes A plastic plate held in the plane of the guard permits flattening of the surface as with glass shoe Holes within this plate are designed to minimize perspiration

the abdomen in the form of fomentations, poultices, hot water bottles, and long and short wave diathermy is used in an effort to cause diminution of the colicky pains A Priessnitz bandage may be placed around the abdomen

Morgan states that among the conditions commonly accompanying colitis are neurasthenia, visceroptosis, and faulty posture He advises the use of vibration applied for three minutes over the visceral reflex centers, the injection of 8 ounces of saline solution into the rectum, and the insertion of a sigmoid electrode for the application of sine wave with eleven contractions a minute This treatment is administered for five to ten minutes and repeated three times a week

#### CONSTIPATION

In spastic constipation, diathermy is advocated to relax the spasm, electrodes are placed on the abdomen and the back To relax a spastic anal sphincter long wave diathermy is administered by means of a rectal electrode In atonic constipation, contraction of the muscles of the abdominal wall is encouraged by electrical stimulation and by active exercise

## CHRONIC GASTRIC CATARRH

Frequent, small, and bland meals should be prescribed in chronic gastric catarrh. After an initial period of rest, increasingly vigorous exercises are administered. Massage, hydrotherapy, heliotherapy and, if necessary, daily

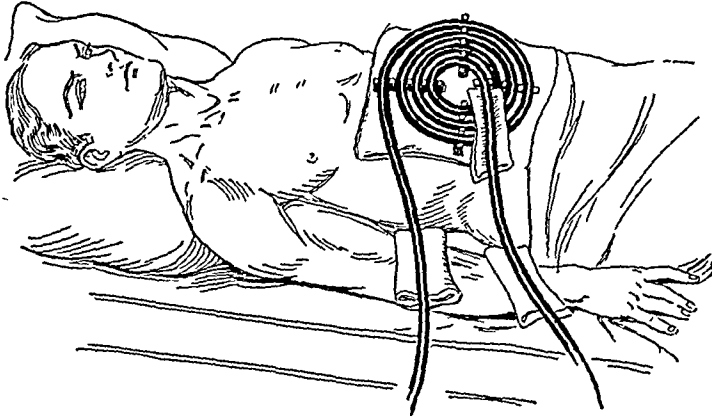

FIG. 286. Short wave current applied to the abdomen by means of coil electrodes.

gastric lavage are among the physical measures utilized to counteract this condition.

## PEPTIC ULCERS

Rest should be secured for the patient with peptic ulcer by a stay in bed and by liquid feeding through a duodenal tube. Hot poultices to the epigastrium may relieve pain. In explanation of the influence of heat, Kowarschik refers to the experimental work of Leube who demonstrated hyperemia of the gastric mucous membrane in animals after the application of warm compresses to the abdomen. He is of the opinion that the danger of gastric hemorrhage induced by heating measures is slight and that bleeding can be produced more easily by mechanical irritation of the stomach than by thermal hyperemia.

## DISEASES OF THE LIVER, GALL BLADDER, AND BILE DUCTS

The possibility of exerting a beneficial effect on chronic inflammations of the liver, gall bladder, and bile ducts by long or short wave diathermy has been suggested by several authors (Fig. 287).

## COLITIS

In treating colitis enemas are administered in an effort to remove the source of irritation. Morgan suggests that rest be given the bowel through

## COLONIC IRRIGATIONS

While some clinicians advocate elaborate apparatus for colonic irrigations, others consider that an enema is as efficacious. The long tube for colonic irrigations appears to have been generally discarded, an insertion of a few

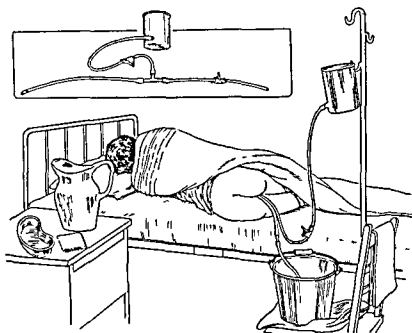

FIG 288 Colonic irrigation

inches is adequate. A simple technique for colon irrigation is as follows. A container of solution is held about two feet above the level of the rectum and connected to the rectal tube by rubber tubing at a glass T. The other arm of the T is connected to a rubber tube which serves as the outflow. By means of clamps, the inflow and outflow are regulated. One half to one pint of solution may be permitted to flow in at a time, the patient's reactions should serve as a guide to the quantity instilled at one time. When the patient complains of discomfort the inflow should be stopped and the clamp on the outlet opened. The irrigation is continued until the returning fluid is clear, that is after the instillation of about one gallon of water. Two rectal tubes may be used instead of one, one of these serves as the inflow, the other the outflow. The inflow tube is of smaller diameter (18-20 French) and is inserted two or three inches deeper than is the outflow tube which is of larger diameter (30-32 French) (Fig 288).

Bastedo's technique of colon irrigation is satisfactory.



## EXERCISES FOR CONSTIPATION

Morgan has recommended the following exercises for constipation:

*Group 1.* Lie flat on the back, without a pillow, with arms folded on the chest. (a) Slowly raise the right thigh to right angle, with the leg extended while counting ten and slowly lower it to the floor while counting ten. (b) Repeat the same maneuver with the left limb. (c) Repeat the same maneuver with both limbs at the same time.

*Group 2.* Position as in Group 1. (a) Slowly raise right thigh to a right angle with the body while counting ten; then carry it slowly to the left as far as possible while counting ten; then slowly return it to the floor by the same route.

*Group 3.* Position as in Group 1. (a) Flex right leg upon right thigh. (b) Flex thigh upon abdomen five times rapidly. (c) Repeat with left limb. (d) Repeat with both limbs.

*Group 4.* Assume standing posture, with hands on hips. (a) Bend trunk forward as far as possible. (b) Resume erect posture and bend as far backward as possible, always keeping the legs rigidly extended; perform these movements from five to ten times. (c) Same position. Carry the trunk over to the right side eight to ten times. (d) Repeat, carrying the trunk to the left side. (e) Position the same. Rotate the trunk to the right side upon the spine five to ten times. (f) Repeat, rotating the trunk to the left side.

*Group 5.* Position as in Group 4. (a) Carry trunk forward. (b) Without assuming the upright position, carry the trunk to the left and backward to the upright position. (c) Repeat in opposite direction.

*Group 6.* Position as in Groups 1, 2, and 3. (a) Slowly raise the head from the floor, while counting five and lower it in the same manner. (b) With arms folded over the chest, raise the trunk from the hips slowly to a sitting position and then return to the recumbent position. (c) With arms folded over the chest and shoulders kept squarely upon the floor, roll the legs and trunk to the left so that their weight is on the left side, the shoulders still being flat on the floor. (d) Repeat with the opposite side.

*Group 7.* Position as in Groups 4 and 5. (a) Bring thigh to right angle with the trunk with the leg flexed. (b) Extend the leg upon the thigh slowly. (c) Slowly return to the original position. (d) Carry the leg backward and upward until the heel touches the buttocks. (e) Slowly return to the original position. (f) Repeat with the left limb. (g) Carry right thigh up until it is strongly flexed upon the abdomen. (h) Repeat with left limb.

*Group 8.* Position as in Groups 4, 5, and 7. Rise on toes from ten to twenty times.

## VISCEROPTOSIS

For the treatment of visceroptosis, Morgan recommends the following regimen. Confinement in bed for a period of several weeks in order to secure complete rest, the foot of the bed may be elevated from 8 to 12 inches. He believes that a firm bed assists the displaced organs to gravitate into their normal location, thus relieving mesenteric drag and improving circulation and peristalsis. A pillow should not be used. The diet prescribed is bland and nutritious and sufficiently bulky to counteract any tendency to constipation. The bowels should be evacuated daily, by means of enemas if necessary. Morgan considers that the most useful enema is a freshly prepared, weak argyrol solution containing 1 drachm of the crystals to 3 pints of water heated to body temperature. It is given slowly with the patient lying on his back, hips elevated, with knees and thighs flexed. General massage assists in the distribution of the solution throughout the colon. The enema should be retained for ten minutes. After seven to ten days, this type of enema is replaced by one that is more bland, such as 5 or 6 ounces of warm olive oil to be retained overnight. This is given at intervals of from two to four days. Or a cocoa butter suppository inserted in the rectum at bedtime and retained overnight may suffice. A second suppository can be given in the morning if necessary. Associated symptoms require additional care. For the treatment of the anemia, iron and arsenic may be administered and ultraviolet rays applied. For general tonic purposes, a cold towel bath, calisthenics, and massage are used.

Muscles of the abdominal wall which have become weakened following operation or childbirth may be strengthened by electrical stimulation which causes them to contract. A sinusoidal or surging faradic current is administered with large, moist pad electrodes, one placed over the abdomen, and the other under the back, for periods of from ten to twenty minutes daily with progressive increase of current intensity. Smart advises that one electrode be placed under the lumbar region and that the other (anterior) electrode be moved about to cause stimulation of the abdominal muscles. He advocates that this procedure be started as soon as five or six days after appendectomy and a week after childbirth, and continued for from one half to forty five minutes daily for three or four weeks.

## TUBERCULOSIS OF THE GASTRO-INTESTINAL TRACT

Ultraviolet radiation plays an important part in the treatment of tuberculosis of the gastro-intestinal tract. Brown and Sampson reported a series of

1. If the patient has not defecated, empty the bowels with a plain water enema and wait fifteen minutes for the defecation reflexes to quiet down.
2. For the first gallon, have the patient lie on the left side with the knees drawn up. After that, have the patient lie on the back.
3. Hang the reservoir so that its midlevel is not more than two feet above the rectum.
4. Having freely lubricated the tubes with white petrolatum, have the patient bear down as at stool and insert the inlet tube five or six inches, allowing the water to flow during the insertion. Then, insert the outlet tube three or four inches.
5. Use plain water at or just above body temperature, and let it run slowly to avoid arousing the defecation reflexes.
6. If the outlet tube becomes plugged, inject a little water through it with a hand bulb. If this does not clear it, withdraw it without disturbing the inlet tube, clean it and reinsert.
7. Terminate the irrigation when convinced that the colon is clean or when you think the treatment has been sufficiently prolonged. We expect an irrigation to consume from six to ten gallons and to take nearly an hour.
8. After the irrigation, have the patient empty the bowels into the toilet. Examine this return before the toilet is flushed.
9. Report particularly on the various odors and on the amount and character of the mucus, feces, and recognizable food particles in each gallon of return.

Some clinicians attempt to change the bacterial flora by injection of acidophilus organisms into the rectum, following colonic irrigations.

De Rivas states that in irrigating the colon he employs solutions at a temperature sufficiently high to kill parasites such as ameba, trichomonas, chilomastix, and oxyuris. He injects a 1 : 5000 hot copper sulphate solution into the colon through a rectal tube. The temperature of the solution in its glass receptacle is from 122° to 128° F. The receptacle is suspended four feet above the lavage table. A rectal tube ½ inch in diameter is inserted 2 to 3 inches into the rectum. A thermometer introduced 4 inches beyond the anal orifice seems to record satisfactorily the temperature of the solution in the rectum; this temperature is controlled by regulating the rate of flow of liquid from the tank and by siphoning it off if necessary. De Rivas emphasizes the importance of maintaining a temperature of 113° to 117° F. within the colon for from five to fifteen minutes. He advises that usually 500 cc. of solution be injected. The patient is placed on his right side with his hips slightly elevated. This intracolonic thermal technique is applied two to three times weekly for the first week, twice weekly during the next two to four weeks, and once weekly for the following two to three months or longer if necessary.

hemorrhoidal mass The usual approach to this problem has been by surgical ligature and excision or by clamp and cautery In the effort to avoid postoperative pain and disability, techniques have been developed which are relatively painless and which permit the patient to attend to his daily affairs while undergoing treatment For strangulated and large, prolapsed, bleeding hemorrhoids, the usual surgical approach is the most satisfactory A refinement of the clamp and cautery technique is the procedure employing the two-active electrode diathermy clamp devised by the author (page 208) These operative techniques require general anesthesia, caudal block, or perianal anesthesia The postoperative pain and discomfort is minimized by means of hot sitz baths and local anesthetizing ointments After two or three days, bowel movement is encouraged by olive oil and glycerin enemas

Fractional methods of destruction can be employed In such a procedure a single hemorrhoid is removed by electrodesiccation carried out through the anoscope (preferably an insulated one) after local anesthetization Kesey has described the technique of negative galvanism He uses a long steel needle, insulated except for its lowermost portion, which is inserted through the anoscope and into the hemorrhoid A moist dispersive electrode attached to the positive pole is placed on some other portion of the body The current is gradually increased Ten milliamperes are permitted to flow for about ten minutes During this period, the color of the hemorrhoid changes It becomes blanched Other hemorrhoidal masses are treated in similar fashion at intervals of about a week No anesthesia is required for the application of this galvanic method The injection techniques (employing sclerosing solutions such as 5 per cent phenol in olive oil) are satisfactory for internal uncomplicated hemorrhoids Thrombosed hemorrhoids usually occur at the mucocutaneous junction They may be satisfactorily treated by incision, turning out of the clot, and electrodesiccation of the interior of the mass Preliminary local anesthetization makes this procedure a painless one, and if done properly it affords dramatic relief of pain External hemorrhoids can be destroyed by electrodesiccation

#### FISSURE IN ANO

Heat produced by medical diathermy applied with a small rectal metallic dilator may give relief in cases of anal fissure If necessary, the surface of the fissure is destroyed by electrodesiccation after a topical anesthetic has been applied to the region Pararectal and ischiorectal abscesses must be incised For this purpose, the cutting current can be used Fistula in ano may be

271 patients so treated, with good results in 73 per cent. Coulter and Hardt note that ultraviolet radiation has a beneficial effect on the major symptoms of gastro-intestinal tuberculosis, that is, the pain, distention, and diarrhea. Similar reports have been made by others. Rollier employs heliotherapy in the treatment of tuberculous peritonitis. He states that solar radiation should be applied cautiously. First the feet are irradiated and then the legs; the abdomen is not directly exposed until the extremities have had long periods of irradiation. After the treatment period for the lower extremities has been extended to thirty minutes the period of exposure is cautiously increased until a maximum dose of thirty minutes is attained. Rollier believes that by primarily exposing the lower extremities, a decongesting action is obtained in the organs of the chest and the abdomen.

Stubenbord and Spies consider the air-cooled mercury arc lamp especially valuable in the treatment of the chronic, plastic, adhesive type of tubercular lesions with localized peritonitis. A dose sufficient to cause a first degree erythema is given every two or three days. The average treatment is started with a three minute exposure, front and back, at a distance of thirty-six inches. The time is increased by one or two minutes at each subsequent exposure until a maximum of from twenty to thirty minutes is reached. This form of treatment may be continued for two to three months.

Coulter and Hardt found that ultraviolet therapy given in conjunction with high vitamin and mineral diet and calcium resulted in marked decrease of symptoms or their complete disappearance. Weight was increased or maintained, abdominal rigidity and tenderness were diminished or disappeared, and roentgenograms showed lessened bowel activity.

#### ABDOMINAL ADHESIONS

The term "abdominal adhesions" is frequently used to denote a post-operative condition characterized by pain. Often the question arises as to whether this pain may not be due to failure to remove the original cause, or to some complication other than adhesions. Unless an immediate exploratory operation is necessary, it is worth while to try converseive heating by diathermy and the short wave current, followed or combined with the surging contractile currents. Cases of "abdominal adhesions" have shown improvement under this treatment.

#### HEMORRHOIDS

A sufferer from hemorrhoids may be relieved in many ways which will vary with the operator as well as with the position and the extent of the

## PRURITUS ANI

The treatment of perianal itching must be governed by the cause. This distressing condition may be amenable to copper sulphate iontophoresis carried out in the manner to be described. Cotton soaked in a 2 per cent copper sulphate solution is wedged into the region between the buttocks so that a firm contact is made with the skin surrounding the anal surface. A metal electrode placed on top of the moistened cotton is connected to the positive terminal of the galvanic machine. A current of from 10 to 15 milliamperes is permitted to flow for about fifteen minutes (Fig 135). Treatment is repeated at intervals of every second or third day. Iontophoresis has also been used with solutions of zinc sulphate and zinc permanganate.

Ultraviolet radiation has been applied to produce a second or third degree erythema. X ray radiation is another method of treatment. Relief has been given in many cases of persistent pruritus by tattooing mercury sulfide into the perianal area. Pruritus perinei in women also has been treated in the same manner (Turrell has described the technique). Persistence of itching may be due to the continued presence of the causative factor, which should be removed if possible (Fig 289).

## REFERENCES

- ALLEN, C. E. *U S Nav M Bull* 34 376, 1936
- BASTEDO, W. A. Rambles in the field of gastro-intestinal therapeutics *New York State J Med* 27 1173-1184, 1927
- BRUNNER, M. Intra esophageal diathermy in dysphagia and cardiospasm *Arch Phys Therapy*, 19 670-674, 1938
- COULTER, J. S., HARDT, L. L. Ultraviolet radiation in gastro-intestinal tuberculosis *Arch Phys Therapy* 20 143-148, 1939
- DE RIVAS, D. Treatment of colon infestation by irrigation and hot instillations *Arch Phys Therapy*, 20 756-762, 1938
- GUTZEIT, K., and KUCHLIN, W. *Munchen med Wchschr* 84 961, 1937
- HIRSCHFELD, I. The Toothbrush, Its Use and Abuse Brooklyn, Dental Items of Interest Pub Co, 1939
- KELSEY, W. E. Obliteration of hemorrhoids with negative galvanism *Arch Phys Therapy*, 15 9, 1934
- KOWARSHIK, J. *Kurzwellentherapie* Vienna, Springer, 1936
- MORGAN, W. G., and HITE, O. L. Physical therapy in gastro-intestinal conditions. In Principles and Practice of Physical Therapy Hagerstown, Maryland, Prior, 1932, Vol I, chap 21

treated in a similar manner. After the fistulous tract has been opened it can be electrodesiccated. The wound is packed with iodoform gauze and permitted to fill in with granulation tissue.

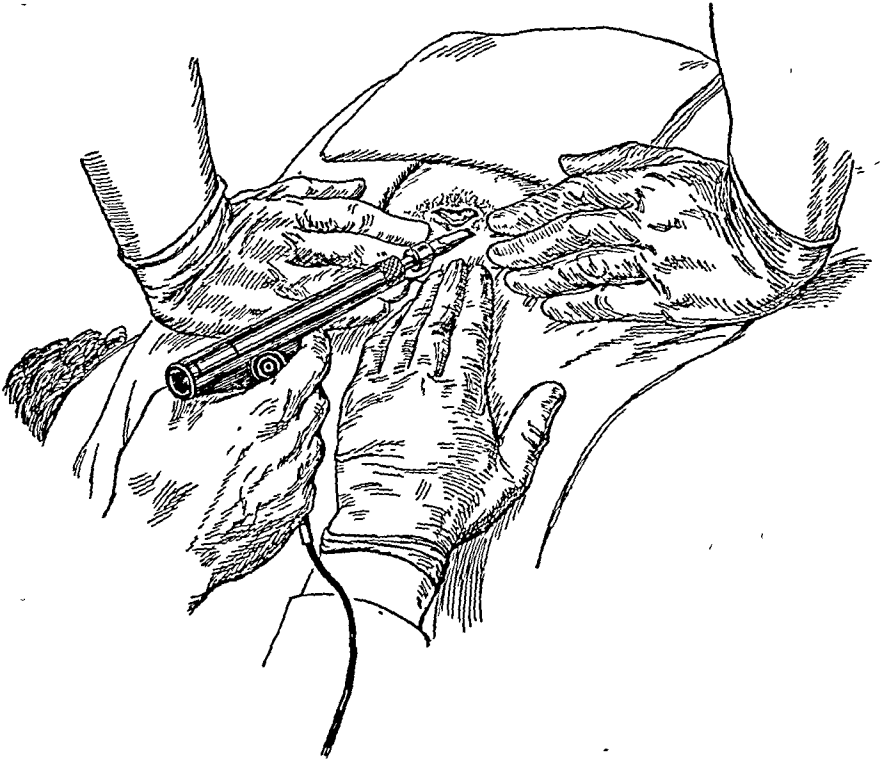

FIG. 289. Technique for tattooing with mercury sulfide for treatment of pruritus ani

#### GROWTHS IN THE RECTUM AND COLON

The various forms of surgical diathermy are valuable for the removal of both benign and malignant growths. Polypi may be desiccated, coagulated, or removed by a snare to which the cutting current is applied. Care is required to make certain that the electrothermic procedures do not cause too extensive destruction with the attendant danger of perforation. To facilitate electro-surgical procedures in the rectum, I have devised an electrode for the application of the high frequency current in a hollow insulated tube through which suction is created (page 210). This electrode holds the tissue to be destroyed against the metallic, current-conveying portions of the electrode irrespective of movements such as those produced by respiration. It maintains a dry and clear field by removing fluid, blood, and smoke. Malignant growths may be removed by the cutting current. Coagulation of the base of the tumor should be followed by radiation therapy.

## CHAPTER XX

# GENITO-URINARY DISEASES

### GONORRHEA

THE USE OF THE SULFONAMIDES IS THE METHOD OF choice in the treatment of gonorrheal infections. Patients who fail to respond to the sulfonamides alone can, in nearly all instances, be rendered gonococcus free by the additional use of one adequate hyperthermia treatment. Four grams of either sulfathiazole or sulfadiazine are administered during the eighteen hours preceding the fever application. Patients who cannot tolerate the sulfonamides can be treated by means of physically induced fever alone. The fact that the gonococcus can be killed at a temperature which does not injure human tissues is the basis for the use of heat in the effort to destroy this organism within its human host. The systemic temperature is elevated to 106° F and maintained at that level for a period of from eight to ten hours.

Local tissue in most parts of the body, including the pelvis, will tolerate a temperature of about 110° F for several hours. Such a temperature exerts a stronger gonococidal action than does the level permissible for systemic heating. However, it is difficult or impossible, with our present techniques, to create such high local temperatures in all the portions of the body which may be invaded by the gonococcus. Electrodes such as those used by Cumberbatch in the urethra and cervical canal in the female, and by Corbus in the male urethra, permit high local temperature elevations in the tissues immediately adjacent to the electrodes, but the tissues beyond the range of influence of such electrodes will not be adequately heated. It is because these local techniques may not be adequate that systemic temperature elevations are used. Local heating applied concurrently can enhance the efficacy of systemic heating. All local heating procedures effective in gonorrhea depend on conversion of the short wave or diathermy currents into heat.

The technique which I have found best for heating the male urethra is that described by Derow. The patient lies on his back. The penis is surrounded with some non-conducting material such as cellucotton and covered



- ROLLIER, A. Technic and dosage of sun treatment of tuberculous peritonitis. *Strahlentherapie*, 60 : 164-169, 1937.
- SAIDMAN, J., and MEYER, J. Les Ondes Courtes en Therapeutique. Paris, G. Doin et Cie, 1936.
- SMART, M. The Principles of Treatment of Muscles and Joints by Graduated Muscular Contractions. London, Oxford University Press, 1933.
- STUBENBORD, J. G., and SPIES, J. Tuberculosis peritonitis. *Am. J. Gynec. & Obst.*, 67 : 269-272, 1938.
- TURRELL, R. Technic of tattooing with mercury sulfide for pruritus ani. *Ann Sur.*, 115 : 126-130, 1942.

posterior technique with electrodes placed on the lower abdomen and on the back does not produce any substantial elevations of temperature within the tissues of the pelvis. A convenient procedure is the use of a pancake coil attached to a short wave machine and placed on a chair so that the patient can sit on it. Diathermy applied with thin metal strip electrodes placed on either side of the penis does not produce adequate heating. Electrodes inserted into the male urethra can cause overheating in the region in contact with the tip of the electrode (Figs 291, 292).

Hot sitz baths have a superficial heating effect, but they do not materially raise the temperature of the tissues lying beneath the surface. Neither does heated water run through a metal or a rubber applicator placed in the rectum. I have never been able to detect any temperature elevation in the male posterior urethra with either of these heating techniques but they may none the less be of value because of the increase they produce in pelvic circulation and as a result of reflex action. Collapsible rubber applicators inserted into the rectum and distended with water at a temperature of 120° F have been employed in the treatment of acute infections of the prostate and seminal vesicles and also in chronic infection of these organs.

#### PROSTATITIS AND SEMINAL VESICULITIS

Acute inflammation of the prostate and seminal vesicles necessitates rest in bed. When symptoms of pus formations are manifested by local fluctuation and systemic reaction, converse heating should be applied cautiously until drainage is established through the urethra, thereafter it can be used more vigorously. If spontaneous drainage does not occur with reasonable promptness, conductive heating (hot sitz baths, hot rectal douches) should be applied, if this is ineffective, the pus should be evacuated by surgical incision.

Experimentally, I have found that it is possible to cause a marked decrease in the temperature of the posterior urethra by means of cold water circulated through a rectal applicator. It would appear logical to use this technique in acute inflammations of the prostate. The vasoconstrictor effect of the cold should reduce swelling of this gland caused by infection, thus avoiding the necessity for catheterization.

Chronic infections of the prostate are usually benefited by converse heat applied through a rectal electrode. These electrodes are of various shapes and sizes. The largest that can be introduced without discomfort should be used as the amount of current energy administered increases with the size of the electrode. The bare metal electrodes are the most efficient, they may

by a plastic cup. A special electrode in the shape of a truncated cone is placed over the cup. This electrode is open at top and bottom. It is made of a thin sheet of metal completely covered with rubber. It is 5 inches in height, 4

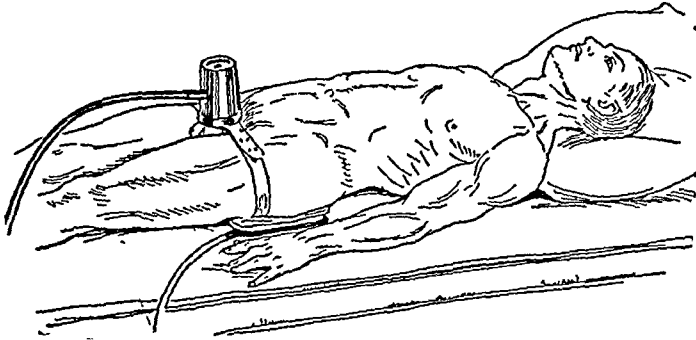

FIG. 290. Short wave current applied to penis. A flower pot electrode surrounds the penis. The other electrode is under the lower back.

inches in diameter at its base, and  $2\frac{1}{2}$  inches at its top. This electrode is connected to one terminal of the short wave machine. The other terminal is connected to a metal electrode inserted into the rectum. A thermometer held within the rectal electrode records the temperature rise in the region of the rectal mucosa. A thermometer can also be inserted into the anterior urethra through a hole made in the top of the plastic cup. In the presence of acute inflammation of the anterior urethra care must be exercised in the insertion of any solid object such as a thermometer; it should not be inserted deeply or retained for a long period of time. When fever therapy cannot be employed because of contraindications or because the patient refuses to accept it, it is possible to treat anteroposterior gonorrhoeal urethritis by means of this localizing technique maintained for from eight to ten hours and repeated daily. Not all gonococcal infections, however, respond to this method of treatment. When it is desired to heat only the penile urethra a dispersive electrode placed under the buttocks is substituted for the rectal electrode. With some machines the cable from the machine to the electrode must be a specific length in order to secure satisfactory temperature changes. Maximum temperatures may also be secured by the insertion of a variable condenser in the course of the cable going to the patient. The effectiveness of the local treatments may be enhanced further by the preliminary injection of gonococidal solutions such as silver salts, mercurochrome, or acriflavine (Fig. 290).

Long or short wave diathermy applied through a rectal electrode causes marked elevation of temperature in the male posterior urethra. The antero-

be cylindrical or slightly curved. Manual massage and the contractile currents such as those secured from the sinusoidal and static machines are additional aids in the care of chronic infections of the prostate. It is possible to administer diathermy and sinusoidal currents simultaneously. Conversive heating is usually applied for a period of about one half hour every other day.

Chronic prostatism is treated similarly with conversive heating and mechanical measures. Surgical intervention is necessary in cases of prostatic enlargement. In the early stages of prostatism or when surgical procedures are contraindicated, the contractile currents secured from the static or sinusoidal machines may prove helpful.

#### EPIDIDYMITIS

In acute inflammation of the epididymis, the patient must be confined to bed, and the scrotum elevated. Gonorrheal inflammation usually subsides on the use of conversive heat applied by diathermy or, more conveniently, by the short wave current. In using diathermy, shallow cup shaped metal electrodes are placed on either side of the involved epididymis and held in position by means of sandbags. The current is administered to the point of comfortable tolerance for a period of from twenty to thirty minutes daily. Short wave electrodes can be arranged in similar fashion. Gonorrheal epididymitis, prostatitis, and vesiculitis resistant to sulfonamide medication is best treated by physically induced systemic elevations of temperature. A single ten hour treatment is ordinarily followed by rapid subsidence of these complications as well as of the urethral infection.

Chronic epididymitis, both gonorrheal and non specific, can be treated by conversive heating and also by means of hot sitz baths. In tuberculous epididymitis, general and local ultraviolet radiation are used. The healing of sinuses is encouraged by ultraviolet radiation. Unilateral involvement may require the use of surgery.

#### URETHRAL STRICTURES

Urethral strictures are a late complication of gonorrheal infection. Usually they can be satisfactorily relieved by dilatation of the urethra with sounds graduated in size. Many years ago Newman described a method of treating small strictures with the galvanic current. The size and location of the stricture is first determined. Then, an olive tipped electrode two sizes larger than the stricture is inserted so that it engages the stricture, and is connected to the negative pole. The positive pole is connected to a dispersive electrode placed under the buttocks or over the abdomen. The flow of current is in-

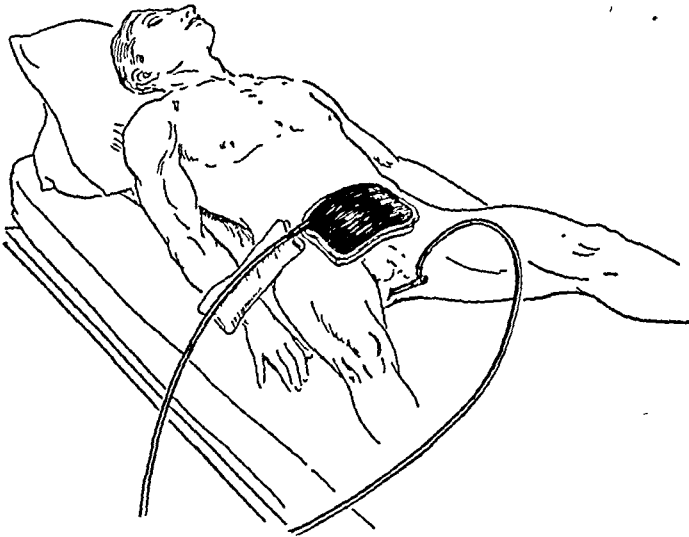

FIG. 291. Short wave current for heating the male pelvis. The metal electrode is in rectum. The semi-flexible plate electrode is on the suprapubic area. The cable is held away from the skin surface by interposition of towels.

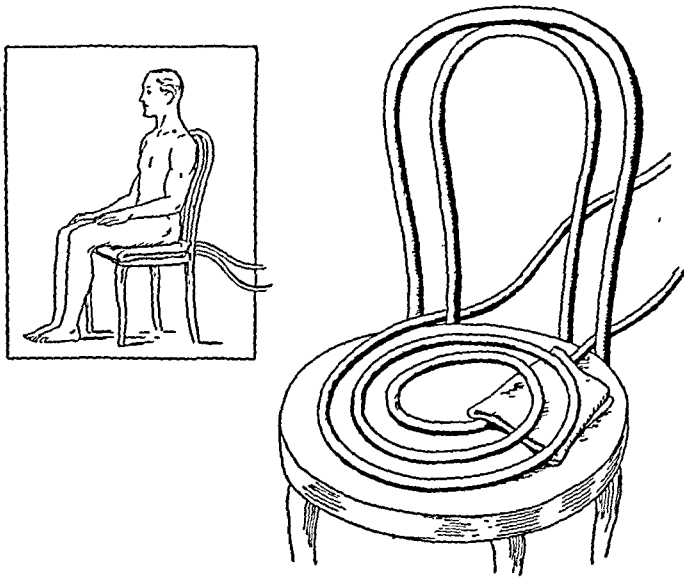

FIG. 292. Short wave current to male perineum and pelvis. Coil technique applied to patient seated on a wooden chair.

ered with a 25 per cent solution of cupric sulphate and the ulcer is fulgurated by means of the monoterminal current and vacuum electrode. Electrodesiccation furnishes a good method for the destruction of the ulcer. Suppuration in the inguinal glands requires incision and drainage. Before suppuration occurs, converse heating to the inguinal glands may be of value.

#### PENILE GROWTHS

Benign growths of the penis, such as papillomata and verrucae, can be destroyed by electrodesiccation. Local anesthesia is achieved by topical applications of a 10 to 20 per cent cocaine solution, or, if necessary, by subcutaneous injection of novocain. After treatment consists in the application of dusting powder and dry dressing. Malignant growths require radical surgical procedures with dissection of the inguinal glands. X-ray and radium therapy are used both preoperatively and postoperatively.

#### URETHRAL LESIONS

Benign growths occurring in the urinary meatus can be destroyed by electrodesiccation. The involved area is first anesthetized with a 10 per cent cocaine solution applied on a swab which should be held in place for a few minutes. Polyps can be destroyed by electrocoagulation. Hypertrophies and tumors of the verumontanum, and granulation tissue and polyps of the posterior urethra, can be eradicated by electrocoagulation. With the destruction of these lesions, the symptoms which they cause—frequency, urgency, and tenesmus—usually disappear. Anesthesia is secured by depositing a 1 gm tablet of novocain in the posterior urethra. If this be inadequate, caudal or general anesthesia is required. Bleeding or varices in the posterior urethra can be controlled by coagulation.

#### POSTERIOR URETHRAL OBSTRUCTIONS

The care of enlargements of the prostate and median bar has been greatly influenced in recent years by the development of high frequency surgery. Initially, these measures were advised for the removal of median bar obstructions. Such tissue can also be removed by means of a tubular knife, as in the Young punch, and the bleeding produced controlled by fulguration. An improvement of this technique, designed to assure better hemostasis, is a tubular knife which cuts and cauterizes at the same time. The Caulk cautery punch is an instrument of this type. The high frequency cutting current applied with a wire loop permits effective cutting with good control of bleeding. An excellent instrument for this technique is the Stern McCarthy

creased slowly. Uthoff suggests that an average of about 0.3 milliamperé be employed for a 100 mm. square cross section area of the olivary tip. He states that the proper dosage ranges from 0.1 milliamperé for size No. 4 French to 1 milliamperé for No. 10 French in direct geometric progression. After the current has been on about five to ten minutes, the olive tip may slip through the stricture of its own weight.

Gonorrheal periurethritis may lead to the development of a persistent urethral fistula. This condition can be satisfactorily treated by the short wave technique described for the elevation of penile temperatures (page 552). Chronic inflammation of the corpora cavernosa is treated with conversive or conductive heat or with sitz baths.

### CYSTITIS

Medicaments are available for the treatment of inflammations of the urinary bladder. Heat-producing procedures may be employed as adjuncts. These include long and short wave diathermy applied by rectal or vaginal electrodes, hot sitz baths, and photothermic radiations to the suprapubic and perineal regions. Small ultraviolet lamps have been introduced into the bladder for the treatment of tuberculous cystitis.

### URINARY INCONTINENCE

Lack of urinary control in children is usually automatically corrected with the approach of puberty. When it exists before this period the possibility of the occurrence of bed-wetting will be minimized if fluids are restricted in the late afternoon and evening. Some device such as a knotted towel or a block of wood may be fastened to the lower back to discourage sleeping on the back. In cases with marked congestion and engorgement of the verumontanum, Harrison states that a single coagulation treatment to the region of the verumontanum may be highly effective.

In adults, postoperative bladder or sphincter atony may be treated with sinusoidal, surging faradic, or static wave currents, with the active electrode placed in the rectum.

### CHANCROID

Harrison found the direct application of argyrol crystals to be very effective in restricting extension of chancroid lesions. If in spite of this measure, the lesion spreads, the procedure suggested by Robbins and Seabury is recommended. The chancroid is cleansed and a 10 to 20 per cent solution of cocaine applied with a swab to secure anesthesia. The area is then cov-

be performed Local ultraviolet radiation helps to heal fistulae which develop in the surgical wounds

## REFERENCES

- BEER, E Quoted by Harrison Electrosurgery and other physical measures in urology In Principles and Practice of Physical Therapy Hagerstown, Maryland, Prior, 1932, Vol II, chap 21
- CORBUS, B C, and O'CONNOR, V J Diathermy in the Treatment of Genito-Urinary Diseases St Paul and Minneapolis, Bruce Pub Co, 1925
- CUMBERBATCH, E P Essentials of Medical Electricity London, Henry Kimpton, 1933
- DEROW, D Treatment of male genitals by short wave diathermy *Arch Phys Therapy*, 19 333-359, 1938
- HARRISON, F G Electrosurgery and other physical measures in urology In Principles and Practice of Physical Therapy Hagerstown, Maryland, Prior, 1932 Vol II, chap 21
- NEWMAN Genito-urinary and proctological conditions In Kovacs, R Electrotherapy and Light Therapy Philadelphia, Lea & Febiger, 1935
- UTHOFF, C J Galvanism in treatment of ureteral stricture *Urol & Cutan Rev*, 42 240-244, 1938



resectoscope. The combined use of the cutting and coagulating currents has permitted removal of lateral intrusions of prostatic tissue. Transurethral prostatic resection requires the same preoperative preparation and care as does prostatectomy. Hemorrhage is controlled by application of the coagulating current directly after a section of tissue has been cut away. The relative safety and simplicity of the transurethral approach for the removal of prostatic obstructions has caused it to become increasingly popular. Contraindications to its use include very large intravesicle and intra-urethral enlargements, the presence of prostatic calculi, local suppurative processes in the prostate, calculi, tumors, or diverticulae in the bladder. Transurethral resection is stated to be able to replace prostatectomy in at least 85 per cent of the cases of obstructive lesions. The lowering of mortality and morbidity rates as well as the diminution in the length of postoperative confinement are advantages of this method of treatment.

#### BLADDER GROWTHS

Beer introduced the technique of coagulating papillomata of the bladder with an electrode passed through the cystoscope. Several treatments may be necessary before the growth is completely destroyed. Papillomata destroyed in this manner may recur. When malignancy is diagnosed, coagulation through a suprapubic cystotomy wound and cystectomy are advised. X-ray and radium therapy are employed preceding and following surgical procedures.

#### URETER LESIONS

To cause relaxation of the ureter, when a calculus is present within it, local application of conductive and conversive heat may be made. When these are not effective morphine should be given to relieve the colicky pains.<sup>1</sup> When a stone lodges in the intravesicular portion of the ureter, ureteral dilatation may prove inadequate for its removal. In such cases, it is necessary to slit the ureter at its orifice.

#### KIDNEY INFLAMMATIONS

In the treatment of nephritis, heat has been recommended. This may be applied locally by means of diathermy or the short wave current or generally through the use of warm baths and cabinet baths. Bilateral tuberculosis of the kidney is treated with general hygienic care, systemic ultraviolet radiation, or heliotherapy. In unilateral involvement, nephrectomy may have to

## VAGINAL DOUCHES

The vaginal douche is employed not only for its thermal effect but also for its mechanical irrigating value and for the introduction of chemicals. Douches are administered once or twice daily by the patient or nurse. Ward has described a satisfactory technique. The apparatus consists of a long, curved, hard rubber nozzle with a two-way flow and a large flange near the distal end to separate the labia. This helps to protect the external parts from irritation by the hot solution. The patient should lie on her back with hips slightly elevated unless the acuteness of the condition requires the Fowler position. The sitting position is not satisfactory. The solutions used are 2 per cent boric acid, bichloride of mercury (1:8000), or potassium permanganate (1:4000). The solution should be instilled at a temperature of about 116° F., and at a low pressure. If the pressure is too high, the solution may be forced through the uterus and tubes into the abdominal cavity. Ordinarily, therefore, not more than two or three feet of water pressure is used for douche purposes. Anderson has indicated a modified douche technique which he has found satisfactory in the treatment of conditions such as chronic pelvic infections or salpingitis. A fountain syringe is filled with boiling water and suspended two or three feet above the body of the patient. The half gallon of solution which is contained within the bag is allowed to trickle through so that thirty or forty minutes are required to empty it. A Hoffman clamp placed on the outflow tube controls the flow and temperature of the solution. The clamp is closed until the water cools in the tube and escapes from the vaginal tip at the desired temperature. If the douche is too hot, the clamp is turned down, if too cool, it is released. The douche can be taken in the bathtub or while lying on the edge of a bed which is protected by oilcloth arranged to direct the water into a slop jar.

## URETHRAL IRRIGATIONS

The urethra can be irrigated by means of a suitable applicator connected to a tank containing sterile water heated to a temperature between 106° and 114° F. The irrigation is continued for about twenty minutes. Insertion of the urethral applicator is preceded by cleansing of the parts. A topical application of 1 per cent solution of silver nitrate may be used after it is withdrawn.

## HEATED INTRAVAGINAL RUBBER BAGS

In the acute stage of pelvic inflammatory diseases, Smith advises that the patient have absolute rest in bed with an ice bag on the lower abdomen for

## CHAPTER XXI

# GYNECOLOGICAL DISEASES

**W**HILE PHYSICAL MEASURES IN GYNECOLOGY ARE most often used in the treatment of inflammatory conditions and new growths, they are also employed as adjuncts to other methods of treatment in non-inflammatory conditions such as stenosis of the cervix, infantile uterus, and abnormalities of menstrual function. The procedures used are negative galvanism, the contractile currents such as the sinusoidal, surging galvanic, faradic, and static wave currents and heat-producing techniques.

### PELVIC INFLAMMATORY DISEASE

Elevation of local tissue temperatures by conductive and conversive heating is a form of treatment that is used extensively in the care of pelvic inflammatory diseases. The conductive methods include hot air, hot water, and heated solid substances such as metal and rubber. The conversive methods include photothermy, diathermy, and short wave currents. Conductive heating measures can cause an elevation of the temperature of the skin, and, when applied intravaginally, a slight elevation ( $2^{\circ}$  or  $3^{\circ}$  F.) in the structures immediately adjacent to the vaginal mucosa. This rise in temperature of the local tissues will occur when water is introduced directly as in a hot douche or when it is passed through an intravaginal applicator constructed of metal or rubber. The beneficial effect of conductive heating on diseased tissue lying deeply within the pelvis is due to reflex activity and increased blood flow, as the vessels dilate in the effort to maintain the normal vaginal temperature. The temperature changes produced within the pelvis following the introduction of cooling and heating measures has been discussed in the chapter on the physiological responses to these measures (page 8). The use of cold is indicated in the early stages of acute pelvic inflammation and when a diminution in pelvic blood flow is desired. The placing of an ice bag on the lower abdomen to relieve pain caused by acute inflammations of the pelvis is a common practice. Water applied directly to the perineum in the form of sitz baths helps to relieve pain (page 45).

produces elevation of the systemic temperature and additional higher temperatures in the pelvic tissues. Both long and short wave diathermy are introduced by means of a bare metal vaginal electrode. Insertion of the

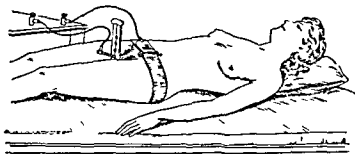

FIG 293 Long wave diathermy applied to the pelvis. Active electrode consisting of bare metal is inserted into the vagina. The holder serves to keep this electrode in place. The dispersive electrode is a broad metal belt.

vaginal electrode is facilitated if the electrode is not too large, and if it is warmed in hot water and lubricated with water-soluble jelly. On the other hand, the larger the size of the electrode the greater the current energy which can be introduced. After the treatment has been applied for a few minutes, it will frequently be found possible to reintroduce a larger-sized electrode. With diathermy the circuit is completed by a large dispersive belt electrode encircling the region below the crests of the ilium (Fig 293). If desired, additional dispersive electrodes may encircle the thighs. The three dispersive electrodes can be connected to one terminal, the vaginal electrode to the other. It is important to use the electrode length best suited to the patient, so that the urethra as well as the cervix is included in the field of local temperature elevation. If the perineum is lacerated, a support may be necessary to hold the electrode in contact with the urethra. We have experimented with a variety of techniques for local pelvic heating, and have found no appreciable difference between the heating efficiency of long and short wave diathermy. We sometimes employ one and follow it with the other in a single treatment, in order to change the distribution of the electric field and thus avoid overheating of the tissues outside of the pelvis. For instance, we may use three and one half hours of long wave diathermy followed by two and one half or three hours of the short wave. Or we may apply long wave diathermy for a total of six hours, in three two-hour periods with one hour intervals between. In a number of patients we tried shorter periods, but found it necessary to increase the number of treatments in order to accomplish the complete destruction of the bacteria (Fig 110).

from two to four days. At the end of this period 5 cc. mercurochrome solution is instilled into the vagina. After the acute inflammation has subsided and the systemic temperature has been normal for four or five days, Smith applies heat by means of the Elliot apparatus. This is a distensible rubber bag filled with circulating water, the temperature and pressure of which can be controlled. It is inserted into the vagina, and, at a rate of 0.5 to 1° F. a minute, the water temperature is gradually raised from 115° F. until 125° to 130° F. is reached. The first treatment usually lasts about fifteen minutes. The length of each subsequent treatment is progressively increased five to ten minutes until the duration is about one hour. The pressure in the vaginal applicator is usually between two and three pounds; the patient's tolerance is a good guide to the amount to be used. Treatments are preceded by emptying the bladder, vaginal douching with a 1 : 5000 potassium permanganate solution, and an enema of soapy water. The treatments are given every two or three days, or, in chronic cases, daily. After the treatment, the vagina should be examined for burns, and if one is observed, a vaseline or boro-glycerin tampon should be inserted and retained for four to six hours. The patient should rest for about an hour after each treatment.

The Elliot treatment is advocated in acute, subacute, and chronic salpingitis, acute and subacute pelvic cellulitis and postpartum and postabortal parametritis, pelvic abscesses, pelvic thrombophlebitis, acute gonorrheal vaginitis and endocervicitis, cystitis, and senile vaginitis. Contraindications are profuse menstruation, postabortal and postpartum tumors, early acute salpingitis and plastic operations of the cervix, bladder, and perineum with much scar tissue. Conversive heating methods (diathermy and short wave currents) are contraindicated in all of the conditions just listed, including some of those for which conductive heating is advised, since the effect of conversive heat may raise the temperature of the pelvic tissues to too high a degree and over too extensive an area.

A modification of the Elliot technique uses air to heat and distend a collapsible intravaginal applicator. Whether heated air or heated water is used, the influence exerted is essentially that produced by the heated rubber of the applicator. The rapidity and degree of heat transferred to the rubber differs, of course, with air and with water as the conducting media.

#### HIGH FREQUENCY CURRENTS

High frequency heating produces the greatest elevations of temperature in the tissues of the pelvis, a fact that is utilized in the killing of the gonococcus. The most effective heating procedure for this purpose is one which

disappearance of the vaginal discharge. The cervical secretion becomes mucoid and clear, with only scattered leucocytes instead of the pus clumps previously found. The urethral smear contains only scattered leucocytes,

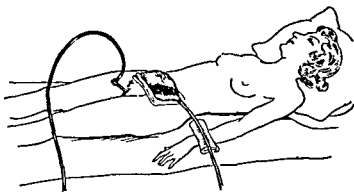

FIG 294 Short wave current applied to the pelvis. Intravaginal and suprapubic electrodes are employed.

epithelial cells, and Doderlein bacilli. In a few cases, superficial mucosal burns have caused a prolongation of the discharge, but after the mucosa heals (within two or three weeks), the discharge disappears. In a few cases, trichomonas vaginitis has caused a continuation of the discharge following the disappearance of gonococci.

About one third of these cases were complicated with salpingitis. In acute salpingitis, pain usually disappears during the first treatment. We have found that treatments may be instituted at any stage of the gonococcal infection, even in the presence of acute salpingitis associated with fever and pelvic peritonitis. Tubo ovarian inflammatory masses, including those which are probably suppurative and associated with a rapid sedimentation time, respond satisfactorily to this type of treatment. There is a diminution in pain, and a return of the temperature to normal the day following the treatment. The temperature remains normal, rapid sedimentation rates become slower. Pelvic examination a few days after treatment usually reveals marked diminution of pelvic tenderness, but only slight changes in the size of the adnexal masses. From seven to ten days after treatment there is usually an increased mobility of the uterus and some shrinkage of the inflammatory masses. Two weeks later the adnexal masses become much smaller.

The first menstrual period following treatment may appear before the expected date and be more profuse and of longer duration than usual. A number of patients with chronic salpingitis associated with painful or prolonged menstruation noticed that menstruation became more regular and less painful following treatment. Pregnancies and normal delivery occurred in a number of patients whom we had treated for gonorrhoea. In several

During the period of pelvic heating, the rectum is also heated, and therefore no longer indicates the true systemic temperature level. The temperature is determined at five minute intervals with thermometers placed under the tongue and in the axilla. These temperatures, as a rule, are not permitted to go above 105° F. We have found it of value to ascertain the relationship between the systemic temperature, as indicated by the rectal thermometer, and the mouth temperature, as soon as hyperpyrexia has been produced and before distortion due to pelvic heating occurs. The relationship between mouth and rectal temperatures has been discussed (page 186). Observations must also be made not only of the systemic and vaginal temperatures, but of the patient's general condition, her color, the character and frequency of respiration, and the pulse.

With the short wave current the dispersive electrode is a large condenser electrode placed either over the lower abdomen and pubic region or under the back. The vaginal electrode may be connected directly to the machine (a proper length of cord is necessary for maximum heating), or a variable condenser can be interpolated. This arrangement is explained in the chapter on short wave diathermy (page 160) (Fig. 294). A thermometer inserted into the vaginal electrode serves as a better index of the temperatures achieved in the tissues than does the milliammeter reading on the machine. A temperature of 109° to 110° F. can be maintained for periods of many hours without causing gross evidence of destruction of the vaginal mucosa. Where the maximum temperature is not the objective as in non-gonorrhoeal chronic pelvic inflammations, a temperature of 105° or 106° F. maintained for about thirty minutes may suffice. As in the treatment of other parts of the body, the heat dosage must be properly regulated. In acute inflammations even the minimum amount of converse heating may aggravate the condition, particularly in gonorrhoeal inflammation. However, the combination of systemic fever and additional local heating yields excellent results even in acute pelvic inflammation. The pelvic contents are not effectively heated by the use of metal plates disposed anteriorly and posteriorly when employing long wave diathermy, or by condenser electrodes similarly placed when using the short wave.

Ninety-three per cent of the cases of gonorrhoea in women which we treated became gonococcus-free. Smears are examined the day after treatment, and if still positive, treatment is repeated on the following day. Once the smears have become negative, examinations are made each day for several days, then at longer intervals. Treatment is repeated at once if gonococci are found again.

Within a few days following adequate treatment, there is subsidence or

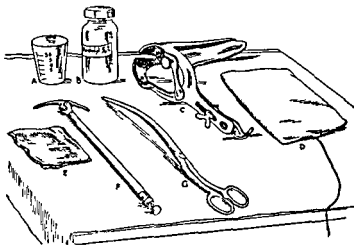

FIG 295 Vaginal iontophoresis of acetylbetamethyl choline chloride (After Jacoby and Der Brucke)

Materials *A* Small glass for holding solution, *B* bottle containing acetylbetamethyl choline chloride solution  $\frac{1}{4}$  of 1 per cent *C* vaginal speculum, *D* dispersive pad *E* small gauze pad *F* vaginal swivel electrode, *G* dressing forceps

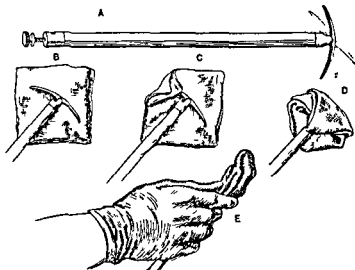

FIG 296 Technique for vaginal iontophoresis of acetylbetamethyl choline chloride *A* The electrode, showing its swivel joint *B* Gauze pad which has been soaked in the solution *C D* Method of folding pad around electrode *E* Method of holding electrode at time of its insertion (After Jacoby and Der Brucke)



patients who had acute salpingitis at the time of treatment, insufflation by the Rubin method subsequently demonstrated normal tubal patency.

The follow-up of most of the cases of gonorrheal infection has been sufficiently prolonged (in some cases extending for a period of seven years) to assure us that the disappearance of the gonococci has been permanent. We have relied on frequently repeated smears, especially those taken directly after cessation of the menstrual flow to determine whether or not the gonococci have disappeared.

High frequency current heating of the pelvis is of value in dysmenorrhea, amenorrhea, cystitis, and chronic inflammatory states such as adnexitis, parametritis, and pelvic cellulitis. In the presence of extensive cicatricial tissue, chronic induration, and adhesions which cause pain because of tubal distortions which they produce, surgical intervention may be necessary. Heating by diathermy or short wave current does not produce the dramatic results in non-specific infections that it does in gonococcal infections.

#### VAGINAL IONTOPHORESIS

Jacoby and Der Brucke report excellent results in the relief of symptoms due to pelvic inflammatory disease by means of vaginal iontophoresis with acetylbetamethyl choline chloride. Their method is applicable both in the acute stage (characterized by pain, elevation of temperature, and other symptoms of pelvic peritonitis) as well as in the late chronic phase. Both local and systemic changes occur with the iontophoresis. Systemic changes are evidenced within a few minutes after the start of treatment; the face and neck become flushed; beads of perspiration appear around the lips and on the forehead; salivation is increased; the pulse becomes rapid; the patient may complain of a choking sensation or of feeling faint. These latter complaints are only in occasional cases. When they do occur, treatment should be discontinued or the current reduced. Usually, the symptoms will then disappear; in rare cases it may be necessary to administer atropine sulphate (grain 1/150). Symptomatic improvement frequently occurs after the first treatment. This subjective change is out of proportion to the objective findings in the pelvis. Pelvic masses diminish in size. Bed patients speedily become ambulatory, and are able to pursue their daily duties without undue discomfort. Der Brucke states that a number of these patients have undoubtedly been saved from the necessity of a major operation (Figs. 295, 296, 297, 298).

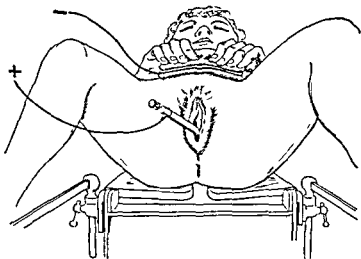

FIG 298 The protruding portion of the electrode points upward and outward indicating that the other end is in the posterior fornix. The electrode is connected to the positive pole of the galvanic machine. The dispersive electrode is approximately 4 by 6 inches in size.

The electrode illustrated consists of a sheet of Crook's metal placed on a piece of thick felt which is saturated with either tap water or salt solution. The metal can be covered with water proof material such as a rubber sheet, on top of which a sand bag is placed. Firm pressure against the sand bag exerted by the patient herself assures good contact between the moist felt and the abdominal wall. The pressure should be exerted downward and slightly forward toward the symphysis. If the contact is not a close one the patient will experience a sensation of tingling and burning. There is then the danger of producing an ulcer. The dispersive electrode is connected to the negative pole of the galvanic machine. A current flow of 15 ma is continued for about twenty minutes. The current should be turned on slowly and turned off slowly. In order to withdraw the vaginal electrode, its protruding portion should be pushed to one side. This causes the transverse arm of the electrode to become extended and so permits ready removal.

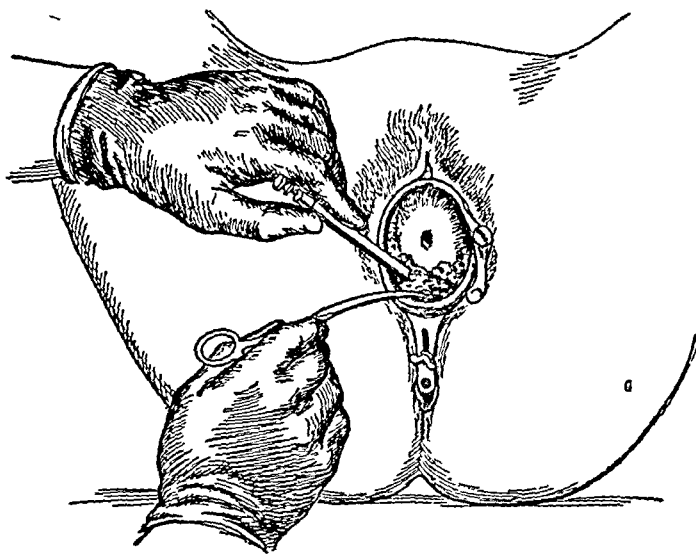

FIG. 297. Patient in lithotomy position. Speculum inserted into vagina and cervix exposed. All secretions have been cleaned away. The gauze-covered end of the electrode has been introduced with the swivel arm extended. Lateral pressure on the external portion of the electrode permits the swivel arm to remain extended until it comes in contact with the mucosa in the posterior fornix. With the aid of dressing forceps, the saturated gauze is packed into the area of the posterior fornix as well as into the right and left fornices. The vaginal speculum is then removed while pressure is made against the electrode, leaving it and the saturated gauze in place.

## COPPER IONTOPHORESIS

Simple chronic cervicitis can be successfully treated by means of copper iontophoresis. This causes comparatively superficial destruction. The dispersive electrode connected to the negative terminal of the galvanic machine is placed on the abdomen or under the back. The active electrode is a straight or slightly curved copper cylinder. These electrodes are made in several sizes to conform to the varying diameters and lengths of the cervical canal. The use of a vaginal speculum permits visualization of the cervix. After the canal has been dilated, the largest copper electrode that will enter the cervical canal is introduced as far as the internal os. This is attached to the positive terminal of the machine. The current is slowly turned on until the meter registers about 15 to 20 milliamperes. The current is permitted to flow for about twenty minutes and then is gradually turned off. During this time it will be observed that the tissue immediately in contact with the electrode becomes greenish in color and firmly adherent to the electrode. The polarity is then reversed in order to connect the active electrode to the negative terminal, and the current again is turned on. After about five minutes, with 10 milliamperes of current, the cervical electrode becomes free from the tissues and may be removed easily. Three to six treatments may be required at intervals of about ten days before the inflammation clears up.

For the treatment of erosion and endocervicitis, Derow combines coagulation with ionization of the cervical canal. The patient is placed on a table in the lithotomy position. A metal plate (6 by 8 inches) acts as the dispersive diathermy electrode and is placed on the lower abdomen. After the coagulation of the vaginal portion of the cervix, nabothian cysts, and the lower end of the cervical canal, the metal plate on the abdomen is replaced by a wet pad which is connected to the negative pole of a galvanic current source. An irrigating electrode of the proper size is dipped into an amalgam which consists of one part pure nitric acid, three parts of water, and some metallic mercury, and is then introduced into the cervical canal. The speculum is then removed. The rubber tube of the irrigating apparatus is attached to the stem of the cervical electrode. Then, the positive pole of a galvanic generator is connected to the stem. A steady flow of solution made with 2 ounces of powdered copper or zinc sulphate dissolved in 2 gallons of water is allowed to flow into the cervical canal. The current is gradually increased until the meter indicates 15 to 20 milliamperes. The treatment is continued for from fifteen to twenty minutes. It is repeated twice weekly for three or four weeks until the slough separates completely.

Contraindications to coagulation and ionization are acute pelvic inflamma-

## ENDOCERVICITIS

In chronic infections of the cervical canal, destruction of the diseased tissue frequently is necessary. This can be accomplished by means of surgical procedures, cauterization, electrocoagulation, the cutting current, or copper iontophoresis. According to Black, surgical intervention should be restricted to extensive and multiple lacerations in women past the childbearing age and to the elongated hypertrophied cervix with prolapse found in the aged.

Cauterization can be used when the disease is confined to the endocervix, the hypertrophy is of moderate degree, and cysts are few in number. Electrocoagulation produces more rapid and deeper destruction of tissues than does the cautery. However, it should be kept in mind that with too extensive destruction there is danger of secondary hemorrhage and stenosis. Both cauterization and electrocoagulation leave the cervix soft, pliable, and normal in appearance. Electrocoagulation and cauterization can be carried out in the office. Local anesthetization can be accomplished by placing a small crystal of cocaine in the cervical canal or by topical applications of cocaine solution. For electrocoagulation a needle-shaped active electrode is inserted into the canal as far as the internal os; the dispersive electrode is placed over the buttocks. Tissue is destroyed in linear fashion. Nabothian cysts are punctured and coagulated. Ward advises that in the after-treatment in order to diminish the number of bacteria in the coagulum, solutions such as Scott's mercurochrome or Bolman's gentian be applied two or three times a week together with alkaline or saline douches on alternate days. (Scott's mercurochrome: mercurochrome 2 gm., distilled water 35 cc., 95 per cent alcohol, 55 cc.; acetone 10 cc.) Bolman's gentian is the same except that an equal amount of gentian violet is substituted for the mercurochrome. Cicatricial adhesions of the cervix may be prevented by the early insertion of narrow dilators or cotton applicators.

Extensive involvement can be treated by conization of the cervix, carried out with the cutting current. After local anesthesia is established a special electrode, constructed of a fine tungsten wire stretched over a silicon tube  $1\frac{1}{2}$  inches in length, is inserted into the cervical canal. With the current turned on, this electrode is rotated through a complete circle. At the end of four or five days, a slough fills the cervical canal; healing is usually complete at the end of the fourth week. Hyams who is an advocate of this technique advises against the use of the vaginal douche in after-care. Conization is best performed shortly after the completion of a menstrual period so that the cervix has the longest time to heal before the onset of another menstruation.

knee-chest position is assumed for ten minutes twice daily. The patient should sleep on her abdomen. In dysmenorrhœa, exercises taken three times a day for ten minutes between periods are advised. These consist of the knee-chest position with variations: lying on the back with knees up, deep breathing with lifting and lowering of the abdomen followed by complete relaxation, contraction of the gluteal muscles with deep inhalations and exhalations accompanied by pulling up the abdomen sharply. Walking on all fours is also recommended.

#### POSTPARTUM EXERCISES

Stander comments on the use of exercises during the puerperium as follows:

"It is our custom to insist on all normal patients having one hour's rest in the midday. During this rest period they are instructed to lie on their abdomen. On the ninth or tenth day each patient is given individual instructions in the proper method of assuming the knee-chest position. Thereafter, it is repeated twice daily for ten minutes at a time. This position should be assumed by all puerperal women irrespective of the findings on discharge examination because of the high incidence of retroversion of the uterus in the puerperium. The length of time the treatments should be continued depends upon the findings and examination done two weeks postpartum.

"Because of the extensive changes in the abdominal wall, physical exercises directed towards strengthening the abdominal wall muscles may be desirable. The most important of these, such as deep breathing, head raising and leg raising exercises may be commenced between the fifth and seventh day. If these exercises are practiced they should be carried out twice daily with plenty of fresh air in the room and continued until the end of the fifth or sixth week.

"*Time for Getting Up* It is the time honored custom to allow the puerperal woman to sit up on the tenth day. This rule, however, should not be slavishly followed, and every patient should be kept in bed until the fundus of the uterus has disappeared behind the symphysis pubis. This frequently occurs by the tenth day, occasionally a day or so earlier, but very often not until some time later. Generally speaking, a two-week's rest in bed is not excessive.

"It is also advisable to give strict directions as to the length of time the patient should remain out of bed. We have found it a convenient rule to direct that she should sit up for one hour on the first day, two hours on the second and to increase the time by one hour each day until she is able to be up all the time."

tions, pregnancy, malignancy, diabetes, syphilis, and tuberculosis of the pelvic organs.

#### CERVICAL STENOSIS

Cervical stenosis is treated with the negative galvanic current applied through a metal electrode inserted into the canal. The current strength is gradually increased from 2 or 3 milliamperes to 10 milliamperes. When the electrode can be readily withdrawn it is replaced with one a little larger and this, in turn, with a still larger electrode during a total period of about twenty minutes. These treatments can be given at biweekly intervals. Dannreuther has employed such procedures in conjunction with endocrine therapy for the amenorrhea and dysmenorrhea of hypoplasia. In amenorrhea contractile currents and converse heating can also be applied through vaginal electrodes. Hirst has applied the static wave current through a vacuum glass electrode in the treatment of vaginismus with favorable effects.

#### GROWTHS OF THE CERVIX, VAGINA, URETHRA, AND VULVA

Electrosurgery is a valuable method for removing papillomata of the cervix and pedunculated fibroids. In the treatment of carcinoma it is used as an adjunct to irradiation with x-rays or radium. High frequency surgery is also of value for the destruction of small growths in the vagina and on the vulva. Urethral caruncles and polyps are readily destroyed by electrodesiccation.

#### INFECTIONS OF BARTHOLIN'S GLANDS AND SKENE'S DUCTS

When Bartholin's glands are infected, the cyst is first incised to permit evacuation of its contents, and the epithelial lining is then destroyed by desiccation or coagulation. Skene's ducts, which may be the seat of a chronic infection, can be destroyed by means of a needle electrode after the region has been anesthetized.

#### USE OF ULTRAVIOLET RADIATION

Systemic ultraviolet radiation is recommended during pregnancy to promote the storage of calcium and to increase the calcium content of the blood. It is stated that eclampsia is prevented by such irradiation. Ultraviolet has also been recommended as a galactagogue.

#### USE OF EXERCISE

Exercise is used in functional disturbances of the pelvic organs. For the relief of back pain caused by retrodisplacement or prolapse of the uterus the

## CHAPTER XXII

# DISEASES OF THE EYE, EAR, NOSE, AND THROAT

### DISEASES OF THE EYE

**S**PECIAL CONSIDERATION MUST BE GIVEN TO THE PHYSIOLOGICAL responses which follow the application of physical measures to the eye, because of the anatomical differences between it and the other organs of the body. The cornea, lens, and ocular media are transparent to radiation of wavelengths between 4000 and 7700 Å. These radiations reach the retina. They therefore form the "visible" portion of the spectrum. The cornea is increasingly opaque to longer wavelengths, absorbing about 50 per cent of the infra red radiation lying between 16,000 and 18,000 Å. Wavelengths shorter than 2950 Å are also taken up by the cornea. The lens absorbs most of the longer infra red rays which pass the cornea, the ultraviolet rays between 2950 and 3200 and some of those between 3200 and 4000 Å. The sensitiveness of the cornea in absorbing ultraviolet radiation is responsible for the production of photo ophthalmia, which occurs six to eight hours after exposure. Infra red radiation may cause injury to the retina and may also be responsible for lens opacities. Eyes differ in their response to radiation. Some persons, for example, are strongly photophobic to radiations which can be comfortably tolerated by others.

Conductive heat and cold as well as convective heat exerts a more profound influence on the structures of the eye than on other portions of the body because of the lack of blood vessels within the ocular media and the relative thinness of the structures of the eye. Cold compresses have been used for many years in the treatment of the initial stages of acute inflammatory and traumatic conditions of the eye. They are usually discontinued after the first twenty four to forty-eight hours, and replaced by heating procedures designed to increase the circulation. Hot compresses not only introduce heat but also interfere with its loss. They can be retained for about twenty minutes and applied three or four times a day. They must be replaced at frequent intervals by fresh ones from a basin of hot water, or hot water from an eye



## REFERENCES

- ANDERSON, C. A. Hot douche. *J.A.M.A.*, 114 : 2449-2450, 1940.
- BLACK, W. T. Treatment of chronic cervicitis. *Arch. Phys. Therapy*, 20 : 427-431, 1939.
- DANNREUTHER, W. T. The office treatment of gynecologic patients. *West Virginia Med. J.*, 24 : 58, 1928.
- DER BRUCKE, M. Personal communication. July 1, 1942.
- DEROW, D. Combined coagulation and ionization of cervical erosions and endocervicitis. *Arch. Phys. Therapy*, 21 : 154-163, 1940.
- HIRST, B. C. The development of infantile uteri. *Am. J. Electrotherapy*, 38 : 4, 1920.
- HYAMS, M. N. Clinical end-results following diathermy in gynecologic conditions. *Am. J. Obst. & Gynec.*, 15 : 224-227, 1928.
- SMITH, E. C. Elliot treatment of pelvic inflammatory diseases of ambulatory women. *New Orleans M. & S. J.*, 91 : 351-356, 1939.
- STANDER, H. J. In: J. W. Williams Obstetrics. New York, Appleton-Century, 1936.
- WARD, G. E. Physical agents in treatment of gynecologic conditions. In Principles and Practice of Physical Therapy. Hagerstown, Maryland, Prior, 1932, Vol. II, Chap. 22.

*Sarcoma* Electrocoagulation for evisceration of the orbit

*Lymphoma* Radium in plaques over the lids X ray may also be used but is not so effective

## DISEASES OF THE CONJUNCTIVA

*Acute conjunctivitis* First twenty four hours, cold packs, after this, moist or dry heat

*Chronic meibomitis* Massage of the lids

*Vernal conjunctivitis* Adrenalin locally and calcium systematically should be tried first Where symptoms are not relieved, radium

*Neoplasms of the bulbar conjunctiva* Surgery Electrocoagulation may be useful if a weak current and a needle electrode are used Radium is dangerous here

*Serpent ulcer* Local applications, atropine, keratotomy In early ulcer, phototherapy may be tried, using the carbon arc with uvioI filter

*Herpetic keratitis* (dendritic ulcer) Phototherapy using carbon arc with uvioI filter eight to ten minutes once a day X-ray—30 per cent erythema dose (one to two treatments)

*Epithelial dystrophy* Phototherapy may be tried

*Degenerated corneal scar with ulceration* Phototherapy as for herpetic keratitis

*Sclerosing keratitis* Phototherapy using carbon arc with uvioI filter for ten minutes every two days X ray—15 to 20 per cent erythema dose, repeated after seven weeks, no more than three or four treatments being given

*Carcinoma* Beta irradiation may be of value Surgery is usually best, followed by careful use of electrocautery where the sclera or interior of the eye is involved If this is refused, radium may be tried

*Phlyctenular keratitis and keratoconjunctivitis* General treatment and atropine The use of sun bath or general irradiation with the carbon arc or mercury vapor arc is of definite value in addition to other treatments

*Corneal scars* Massage of the cornea and the use of dionin are probably of as much value as anything in helping to clear scars The use of iontophoresis has been advised, but its value is questionable

## DISEASES OF THE IRIS AND CILIARY BODY

*Tuberculous iritis* General treatment and atropine are most important X ray as described for sclerosing keratitis may be tried, but is not without danger of causing cataract Hence it is contraindicated in the ordinary forms

dropper may be added with the compress in place. Infra-red radiation and phototherapy are convenient and effective methods for applying dry heat. Infra-red radiation and diathermy should be employed with a knowledge of their dangers. It is possible to heat the contents of the orbit by long wave diathermy. Monbrun and Casteran cautioned against the danger of generating too much heat in the eye by this method. They state that intra-ocular tension is increased by such conversive heating energies, and that they should not be applied in the presence of glaucoma.

Special lamps have been designed for the local application of ultraviolet radiation. A popular one is the Birch-Hirschfeld. This consists of a carbon arc lamp with a uviol glass filter and a quartz lens system to permit focusing of the radiation on the cornea. The infra-red rays are absorbed by a cell filled with distilled water. The uviol filter removes some of the infra-red, much of the visible, and some of the shorter ultraviolet radiations. In treatments, the lamp is applied for about three and one-half to six minutes.

The following summary of the diseases of the eye and the physical methods employed in their treatment is given by Gifford.

*Hordeolum*: Moist heat, incision.

*Chalazion*: Incision and curettage. Electrocoagulation; if on the lid border, 200 to 300 milliamperes for one second.

*Xanthelasma*: Surgery is simplest in most cases. Thermophore may be effective. Radium is effective but requires care.

*Blepharitis*: A trial of ointments and moist heat should be made. In resistant cases, x-ray is most effective.

*Trichiasis*: Electrocoagulation: 150 milliamperes for one second. If more than five or six lashes are affected, surgery is simpler.

*Dermatitis*: X-ray is effective in small dosage.

*Carcinoma*: Surgery for small growth not adherent to the bone. X-ray where large areas of skin are involved. Radium for growth at lid border or in the inner or outer angle, with adhesions to bone.

*Naevus flammeus, Hemangioma*: Radium, especially for capillary hemangioma. Surgery for hemangioma supplied with large vessels.

#### DISEASES OF THE ORBIT

*Cellulitis*: First twenty-four hours, cold packs. After this, moist heat and incision. Medical diathermy, 200 to 400 milliamperes for five to ten minutes may be tried.

*Carcinoma*: Radium needles or tubes of radon embedded in growth. Where orbit is to be eviscerated, electrocoagulation (surgical diathermy).

sympathetic ophthalmia, inflammatory foci in retina, and choroid and retinal hemorrhages In the treatment of inflammatory conditions of the eye, I use air spaced electrodes—one placed anteriorly to cover the region of the eye and surrounding portions of the face, and the other placed posteriorly over the region of the occiput and upper neck. Conversive heat can also be applied to the eye by diathermy, as described in the chapter on this subject (page 125)

Systemic elevation of temperature by physical heating has been reported as successful in corneal ulcers, acute iritis, exudative iritis, neuro-retinitis, choroiditis, iridocyclitis, gonorrheal conjunctivitis, and syphilitic interstitial keratitis (in combination with chemotherapy) In some cases it has checked the progress of syphilitic optic nerve atrophy

Local destructive heating is used for surgical removal of small growths such as papillomas, angiomas, and cysts, electrodesiccation, for small tumors Electrocoagulation with a special puncture technique is also employed in detachment of the retina, to secure adhesion between the choroid and retina

The galvanic current has been applied by a special electrode for stenosis of the lacrimal duct This electrode is attached to the negative pole of the machine Friel advocated the use of zinc iontophoresis for corneal ulcers—about 1 milliampere of current for five minutes Some European physicians recommend calcium iontophoresis through the eye for the treatment of diseases of the eye, and also for hemiplegia

Gifford recommends massage for corneal ulcers, chronic infections of the meibomian glands, and glaucoma In corneal ulcers, massage hastens absorption of scar tissue After a 2 per cent solution of yellow oxide of mercury ointment has been applied to the conjunctiva, the eyeball is massaged through the closed lids for five minutes three times a day The purpose of massage in glaucoma is to diminish, if possible, the tension when a filtering operation has not produced satisfactory results The eyes are compressed alternately by two fingers about thirty times, two or three times a day In infections of the meibomian glands, massage is accomplished by holding the lids away from the eye, and pressing them between the thumb nails of both hands, or by holding a glass rod on the conjunctival side of the lid while finger pressure is made on the outside

Exercise is used in the non paralytic variety of squint and muscle imbalance to stimulate the fusion sense in order that the eyes may be moved together

#### DISEASES OF THE NOSE

Infections and diseases of the nose can be benefited by physical therapeutic measures New growths can be electrodesiccated and electrocoagulated Erysipelas responds to irradiation with ultraviolet and phototherapy

of iritis and other diseases of the iris and ciliary body. Beta irradiation may be of value.

#### DISEASES OF THE CHOROID

No form of local physical therapy is effective, probably. In tuberculous choroiditis the use of sun baths or generalized light baths with the carbon or mercury vapor arc may be of value.

#### DISEASES OF THE RETINA

*Glioma retinae* (retinocystoma): Enucleation of the first eye, followed by radium in the orbit if there is recurrence. If the second eye is involved, a choice may be offered between enucleation and x-ray or radium.

#### DISEASES OF THE OPTIC NERVE

Not amenable to physical therapy.

#### INTRACRANIAL DISEASES

*Pituitary tumor*: If it is probable that the tumor is an adenoma, roentgenotherapy may be tried, large doses being directed to the sellar region through the two temporal regions.

If vision continues to fail after one or more treatments, no time should be lost in advising surgical intervention.

Radium is used only where the tumor has eroded the floor of the sella, or after sellar decompression has been done.

*Cerebral tumors*: When the tumor is inoperable or has been only partially removed, decompression should be performed if the vision is being damaged. Deep roentgenotherapy may then be tried.

*Glaucoma*: Glaucoma is not amenable to physical therapy, except for the relief of pain by heat or cold and the use of massage for promoting filtration. X-ray and radium are contraindicated in the presence of glaucoma.

*Cataract*: No form of physical therapy is indicated for cataract. The danger of producing cataract is one of the chief reasons for avoiding the use of radium and x-ray except for those cases in which it is essential. When it must be used the globe should be carefully protected when this is possible.

Successful results with short wave diathermy have been reported in infections following perforating wounds, acute dacrocystitis, phlegmonous diseases of the lacrimal sac, iritis, retrobulbar neuritis, corneal ulcer, syphilitic keratitis, herpes of the cornea and chronic iridocyclitis, acute orbital abscess,

purchase and which may give him relief if he permits it to shine at comfortable tolerance for an hour or so, two or three times during the day. Following such heating measures, the patient should not go out directly into a colder atmosphere. The "*Kopflicht bad*" is a small cabinet containing four small lamps, which is placed directly over the patient's head so as to enclose it (Fig 51). A sitting rather than a lying position encourages drainage. This treatment may be applied once or twice daily for thirty minutes. Its beneficial effect is attributed to the reflex influence of heat applied to the skin, the penetration of some of the radiation to the tissues involved, and the dehydration caused by the heated and dry air inhaled through the nose.

It is still a matter of discussion as to whether it is possible to prevent the development of common colds by periodic exposures of the entire body to ultraviolet radiation. Maughan found a definite reduction in the incidence of colds among students at Cornell University who were exposed to minimal erythema doses of ultraviolet once a week during the winter. Exposure to a carbon arc lamp often appears to abort a cold if made immediately after the appearance of the premonitory symptoms. This form of radiation is also of value in the early, acute stages. Directly following its use, the patient may be able to breathe more freely through his nose.

#### VASOMOTOR RHINITIS

*Hay Fever* If the allergens responsible for hay fever can be determined in a given case, the patient's environment should be changed to avoid contact with them, or he should be desensitized against them, when possible. Zinc iontophoresis is an auxiliary measure which seems to be of value in many instances. Several techniques for this procedure have been described: (1) Direct application to the nose of a 2 per cent solution of zinc sulphate by means of a U shaped glass applicator into one arm of which is placed a wire connected to the positive pole of the galvanic machine, (2) intranasal tampons made of strips of gauze soaked in zinc sulphate solution, and (3) instillation of a 2 per cent zinc sulphate tragacanth jelly. We have found this last procedure a most convenient one. Four to 6 cc of this jelly are inserted into one side of the nose. Electrical contact is made with a wire running through a button moulded of plastic material into a self retaining shape. The circuit is completed by placing a moist pad electrode (which is connected to the negative pole) under the forearm as the patient sits beside a table. (This electrode can be put on any other part of the body.) A current of about 5 milliamperes for five minutes is usually employed. The current strength is gradually increased and adjusted in accordance with the patient's tolerance.

## NASAL FURUNCULOSIS

Physical measures which are effective in local infections are particularly indicated in furunculosis of the nose because of the special danger involved in surgical manipulations. Hot compresses with or without the addition of magnesium sulphate or boric acid are of value. Phototherapy affords a convenient and effective form of heat. Applications for twenty to thirty minute periods, at intervals of two to three hours, will relieve pain and encourage localization of the infection. Brief and mild exposures in the field of the short wave current may help.

## EPISTAXIS

Inasmuch as bleeding from the nose may have a systemic as well as local cause, both etiological factors should be investigated, and treated if possible. Hypertension, avitaminosis, blood dyscrasias, and other conditions may be the underlying cause of epistaxis. The site of the bleeding is usually in the anterior lower portion of the nasal septum known as Kiesselbach's area. Inspection may reveal telangiectasis, ulceration, or a malignant growth. Ice applied to this area may stop the bleeding. For more permanent and effective hemostasis, the bleeding point should be cauterized with trichloroacetic or chromic acid or by the galvanic current. As these lesions are relatively superficial, they can usually be treated successfully by fulguration or electrodesiccation. When using electrocoagulation the danger of too extensive destruction and possible perforation of the septum should be kept in mind.

## ACUTE RHINOSINUSITIS

In the usual "cold in the head" the sinuses are involved. It is difficult to believe that the extensive local and systemic symptoms are due to an inflammation restricted to the tissues within the nose itself. Lacking a specific remedy for the common cold, reliance is placed on the time-honored measures of rest, copious imbibition of fluids, hot foot baths or general baths, hot drinks, whiskey, salicylates, and copaverine.

In addition, astringent solutions may be applied by means of an atomizer or dropper to shrink the mucous membrane of the nose, and so encourage drainage. Suction serves the same purpose. For topical medication, solutions containing silver salts or sulfonamides are deposited in the nose. Heat applied to the nose and the surrounding area by hot compresses, steam inhalations, infra-red and photothermal radiations usually gives relief. The 260 watt carbon filament lamp is an inexpensive apparatus which the patient can



FIG 299 Nasal iontophoresis with zinc Step 1 Instilling zinc sulphate jelly into nose



FIG 300 Nasal iontophoresis with zinc Step 2 The nasal electrode is connected to the positive terminal The dispersive electrode is under the arm and connected to the negative terminal



For some patients, 3 or 4 milliamperes may be all that can be administered without causing discomfort; for others, 6 or 7 milliamperes may produce no discomfort. The smaller amperage should be applied for a correspondingly longer time period. A local anesthetic is not usually required when employing these relatively low amperages. To minimize the possibility of an uncomfortable reaction it is advisable to treat the two sides of the nose separately. However, disagreeable reactions have appeared so infrequently that it is permissible to treat both sides at one time. Treatments can be repeated at intervals of about one week. Three or four treatments may be sufficient. For hay fever, zinc iontophoresis is started about a month in advance of the expected onset of the symptoms (Figs. 299, 300). Dr. A. W. Schenker has helped to develop this technique.

#### ATROPHIC RHINITIS

There seems to be no satisfactory treatment for atrophic rhinitis. The nose can be packed with gauze strips soaked in normal salt solution and attached to the positive pole of the galvanic machine. Five to ten milliamperes of current are applied for about fifteen minutes. Intranasal ultraviolet radiation by means of quartz rods and radium emanations are advocated. Russell found that even in bad cases of ozena, ultraviolet radiation will relieve the pain and destroy the odor, except in cases of syphilitic origin.

#### HYPERTROPHIED TURBINATES

The application of heat sufficient to cause tissue destruction is advised for the care of hypertrophied turbinates. This heat may be in the form of galvanocauterization, electrodesiccation, or electrocoagulation. One or two small punctures destroying intermittent areas of mucous membrane may be all that is needed. Extensive galvanocauterization or electrocoagulation should be avoided as it may produce excessive scar tissue and adhesions. To avoid destruction of a considerable portion of the mucous membrane, submucous electrocoagulation can be used. This offers several advantages: absence of primary or secondary bleeding; absence of pain under adequate topical analgesia; mild local reaction of the mucosa; absence of synechiae formation; and preservation of mucous membrane. To carry out the procedure, a long surgical needle, insulated except for 1 mm. at its point, is connected to the diathermy machine by a suitable handle. This needle is inserted into the head of the inferior turbinate and pushed toward the posterior end; it is then slowly withdrawn while the current remains on. The same procedure is repeated along the inferior aspect of the turbinates. Hypertrophic posterior ends of the turbinate can be destroyed by coagulation or with the current

"colds," gaseous fumes, dust, changes in temperature and humidity of the air as the individual goes from a dry, heated indoor atmosphere to the cool, moist outdoors of northern winters, may be responsible for the reappearance of sinus symptoms

In carrying out converse heating for sinusitis, we employ flexible electrodes with spacing material interposed, or air spaced rigid plate electrodes. The flexible electrodes are oblong in shape one is placed under the region of the neck and upper back as the patient lies on the table, the other is applied to cover the area of the sinuses (lower portion of the forehead, nose, eyes, and cheeks). This all inclusive technique is used even when the symptoms indicate involvement of only one sinus. The anterior electrode is held in place by an elastic bandage placed around the head or by a light sandbag. If a sandbag is used, its weight should be disposed over the region of the forehead, as it may cause an unpleasant pressure on the bridge of the nose if placed further down on the face. In some instances we have used a butterfly-shaped electrode instead of the rectangular anterior electrode in order to permit the eyes to remain uncovered. The current adjusted to the point of comfortable heat tolerance is permitted to flow for twenty to thirty minutes. When employing rigid electrodes with air spacing, the patient is usually seated, and the electrodes are applied anteroposteriorly. It is also possible to arrange the electrodes laterally on either side of the face or to use the coil technique with the coil or drum held in front of the face (Figs 301, 302, 303).

Sinus drainage may be encouraged prior to application of short wave current by intranasal zinc iontophoresis carried out as in vasomotor rhinitis and hay fever, or by other measures such as suction and irrigations. In acute exacerbations the interference with drainage caused by congestion of the mucous membranes may make it advisable to employ less thorough methods of heating such as infra red radiation and photothermy. Rubenstein applies conductive heat to the nasal mucosa by means of a modified "Elliot" technique. Long, narrow, rubber tubes are inserted into the nose and water at a temperature of  $130^{\circ} F$  is circulated through these tubes at a pressure of from 1 to 5 pounds.

#### DISEASES OF THE PHARYNX

Both conductive and converse heating are used in the treatment of acute pharyngitis. Conductive heating can be carried out with hot compresses, or by infra red or photothermal radiation to the region of the neck for a period of twenty to thirty minutes, every two or three hours. Converse heat by

applied through a snare. Zinc iontophoresis, employing about 10 milliamperes for from ten to fifteen minutes, has been used to cause a diminution in the size of enlarged turbinates.

#### SINUSITIS

Thermocouple determinations in living human subjects have demonstrated the possibility of raising the local temperature of the paranasal sinuses by conversive heating. The physiological response to local temperature elevation may explain the efficacy of this measure in paranasal sinusitis. As in the treatment of other inflammatory conditions, the value of the active hyperemia induced depends on the presence of adequate drainage. The degree of improvement obtained may be influenced by local and general factors such as the presence of polypi, enlarged turbinates, deflection of the nasal septum, and exposure to irritating atmospheric conditions. Displacement irrigations and similar local measures may be used in conjunction with the short wave current, although this current alone is frequently adequate to effect improvement.

About two thirds of the patients in a large series of cases of sinusitis derived benefit from conversive heating with the short wave current. In spite of the fact that these patients had been subjected by able specialists to the usual nose and throat procedures, straightening of septa, removal of turbinates, puncturing of antra, irrigations, tampons, and other surgical measures designed to afford drainage to the affected sinuses, their symptoms persisted. The patients who complained of headaches and pain associated with their nasal or postnasal discharge secured the greatest relief from the treatment. Frequently, the amount of nasal discharge was augmented after the first few treatments. When an increase in headache or pain occurred, drainage was inadequate or treatment too severe. No other untoward results occurred. A diminished postnasal drip may persist although all other symptoms disappear.

In the cases which responded favorably to conversive heating, improvement was noticeable after a few applications. In many instances ten or twelve treatments sufficed to bring about subjective improvement, which appeared to be relatively permanent. This improvement was not always paralleled by objective changes such as the disappearance of cloudiness in the roentgenograms and alterations in the appearance of the mucous membrane. The relief of symptoms in these patients has persisted for periods of from several months to several years, and it is not necessarily a reflection on the efficacy of the method that recurrences do take place. Even if it were possible to restore the sinuses to their original healthy state, the factors which caused the sinusitis may continue to be operative. Thus, contact with people suffering from

side of the neck can be administered once a day to the point of comfortable means of diathermy and short wave current with electrodes placed on each tolerance

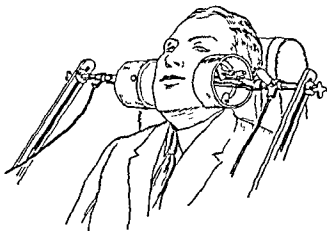

FIG 304 Short wave current applied to both sides of neck in the treatment of tonsillitis (After Liebesny)

In chronic pharyngitis, conductive heating by compresses and convective heat by the short wave current or diathermy are used. Ultraviolet radiation may be applied to the region of the inflamed pharynx, with the official quartz applicator attached to a "cold quartz" lamp or to the liquid-cooled "hot quartz" lamp. Laryngeal tuberculosis is treated by radiation with ultraviolet and by electrothermal destruction. Localized regions of hypertrophic lymphoid tissue can be destroyed by electrodesiccation or electrocoagulation. Electrocoagulation can also be used to remove lingual varices and tonsils, adenoid tissue, and malignant growths such as carcinoma of the tongue.

#### TONSILS

*Tonsillitis* Physical measures that have proved good adjuvants in infection of the tonsils are hot compresses, phototherapy to the neck, high frequency currents with electrodes placed on either side of the neck, and direct ultraviolet radiation by means of quartz rods. These methods are not sufficiently efficacious to warrant their use to the exclusion of the customary medical treatment with rest, salicylates, topical chemical applications, and so forth (Fig 304)

Chronic infections of the tonsils indicate the need for removal of these organs. This is best accomplished by the usual surgical technique, but when the patient's condition contraindicates a surgical approach the tonsillar tissue can be destroyed by either electrodesiccation or electrocoagulation with the



FIG. 301. Short wave current applied for paranasal sinusitis. Flexible electrodes disposed anteroposteriorly. A towel is interposed between head and electrode, and a rubber bandage applied to hold both in position.

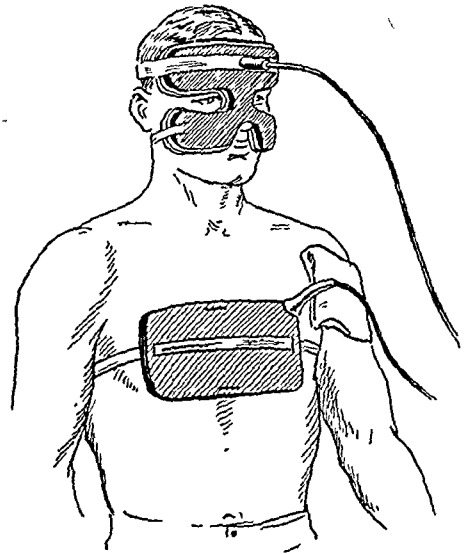

FIG. 302. Short wave current applied for paranasal sinusitis. A butterfly electrode is placed on the face; the other electrode on the chest.

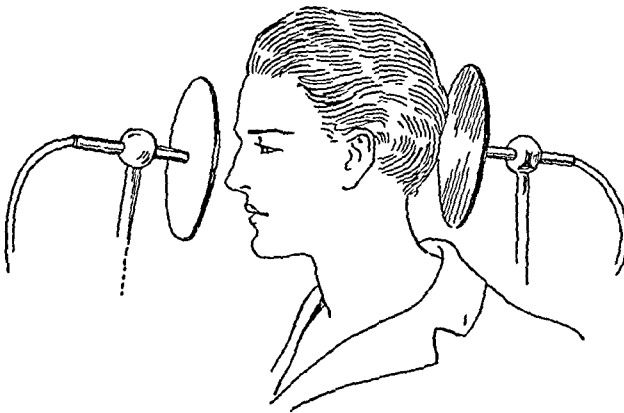

FIG. 303. Short wave current applied for paranasal sinusitis. Rigid electrodes are held in the anteroposterior position.

adjacent tissue at a sufficient distance from the point of insertion to prevent complete coalescence of the coagulated surfaces. About seven or eight such punctures can be made at one treatment, with care to avoid injury to the

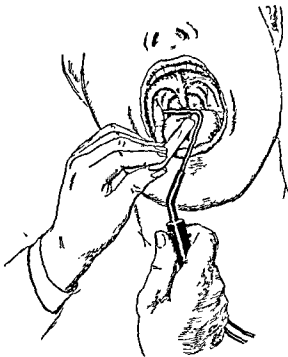

FIG 305 Coagulation of tonsil with suction electrode

tonsillar pillars. Following the coagulation, the patient is instructed to use a mild antiseptic mouth wash or Thantus lozenge if he experiences any discomfort. The second tonsil is treated in similar fashion after an interval of about a week. The initial tonsil is then retreated at the end of the second week. Alternate weekly coagulations are continued until the desired amount of tonsillar tissue has been destroyed. This may require from six to twelve or more treatments.

Instead of employing one active and one dispersive electrode it is possible to use an apparatus consisting of two active electrodes. The pronglike instrument formed by the two electrodes is inserted into the tonsillar tissue. Coagulation takes place for the most part, though not exclusively, in the tissue lying between the two needle like electrodes. Another electrode which I also devised utilizes suction in addition to coagulation. Suction facilitates the operation by removing fluids and smoke (Fig 305). A hollow tube made of insulating material contains one or two electrodes. When two are used, one is pointed, and surrounded by the other which consists of a small, metal ring. The tube is connected to a suction apparatus and to the diathermy ma-

high frequency currents. With electrodesiccation, the area that can be destroyed is very limited; therefore when there is more than a small amount of tissue to be destroyed, electrocoagulation is the better procedure.

The removal of tonsillar tissue by electrocoagulation offers several advantages: It does not require hospitalization; the patient can go about his regular activities without loss of time other than that which he spends at the doctor's office. When properly performed, the local reaction is not great enough to interfere with swallowing. Portions of the tonsil may be destroyed if it is not desired to remove all the tissue. There is practically no hemorrhage nor evidence of shock. The disadvantages of electrocoagulation are the necessity for repeated treatments over a period of weeks; the danger of secondary hemorrhage if a large amount of tissue is destroyed at one treatment; the special skill required to remove properly the tonsillar tissue and at the same time avoid injury to the pillars and underlying structures including the carotid artery; and the difficulties encountered with nervous patients and children.

The indications for high frequency technique for the removal of tonsils include organic diseases such as hemophilia, hypertension, cardiac diseases, diabetes; the presence of only small amounts of tonsillar tissue; and a patient's aversion to surgery.

*Technique.* Electrocoagulation of tonsils should be preceded by local anesthetization of the area surrounding the tonsils, the palate, pharynx and base of the tongue. This can be accomplished by spraying or swabbing with a local anesthetic such as 10 per cent solution of cocaine. The patient is seated on a chair and proper arrangements made for illumination of the interior of the mouth. An insulated tongue depressor and pillar refractor will help to bring the tonsillar tissue into view. Previous to actual coagulation of the tonsil, the settings on the machine should be adjusted by experience and by experimentation on a piece of meat. It will be found that the milliammeter will register about 300 to 400 milliamperes when the circuit is closed. During the actual performance of the operation the meter should be shunted out of the circuit. When the single needle electrode technique is employed, one terminal is connected to the patient by means of a large metal plate applied to the back or by a metal rod which the patient holds in his hand, and the other to the needle. A foot switch leaves both of the operator's hands free. The electrode is pointed and insulated except for the region near its tip. It is inserted into the tonsillar tissue, and the current is turned on, blanching the tissue surrounding the electrode for a distance of a few millimeters. After the current is discontinued, the electrode is removed and reinserted into the

exposure for one minute a day for a week, to be followed by gradually increasing periods until ten minutes of exposure are given at the end of several weeks. Increased rawness and local irritability indicate that radiation should be discontinued or diminished. In the direct technique, a special carbon arc lamp designed by Wessely or a quartz rod connected to a fluid-cooled mercury lamp or to a cold quartz lamp is used. The diseased area may also be destroyed by electrodesiccation or cauterization.

Growths in the larynx can be destroyed by electrocoagulation. In carcinoma, this technique can be employed in conjunction with laryngofissure or hemilaryngectomy or extirpation of the larynx.

#### PARALYSIS OF THE LARYNX

Physical measures sometimes afford relief in the paralysis resulting from peripheral neuritis. Measures which are applicable are heat by means of converse current with electrodes placed on either side of the neck, and stimulation with the galvanic or faradic currents. In hysterical paralysis, the laryngeal area can be treated with painful faradic stimuli, with diathermy or short wave currents or with the vacuum or non vacuum electrodes attached to the diathermy machine. Laryngeal paralysees caused by diseases such as aneurysm and mediastinal growths do not respond to physical therapy.

### DISEASES OF THE EAR

#### OTTIS EXTERNA

Inflammation occurring in the external auditory canal may be either diffuse or localized (as in furunculosis). In the treatment of this condition heat is applied in the form of hot compresses of magnesium sulphate, aluminum acetate, or boric acid, or by radiation from photothermal or infra red sources. The inflammation may resolve or progress to suppuration. After drainage is established, heating measures should be reapplied. Tin iontophoresis of the external canal has been advised. This procedure is carried out by placing a solution of stannoxyl held within an insulated ear speculum which is connected to the positive pole of the machine. The negative electrode is a pad which may be placed anywhere on the body. Three to five milliamperes of current for a ten minute period are administered daily. Local irradiation with ultraviolet rays through a quartz rod is of value in the acute stage of otitis externa, and after the inflammation subsides it helps to prevent recurrences. The patient should be careful not to traumatize the canal.



chine. The tonsillar tissue which is to be destroyed is drawn up into the mouth of the hollow tube, and held there by suction while the coagulating current is applied. This arrangement avoids the possibility of breaking the contact between the tissue to be destroyed and the coagulating electrode. If the patient moves or gags, the danger of destroying adjacent tissue such as the tonsillar pillars and uvula is avoided. This suction-surgical electrode may also be used for the destruction of tissue in the pharynx, larynx, and other portions of the respiratory tract as well as in other regions of the body. The certainty of destroying only the desired area is assured by the suction which maintains a constant relationship between the tissue and electrode; by the relative avascularization of the tissue resulting from the pull upon it; and by the two active electrodes.

The thoroughness with which the tissue is destroyed will depend on the persistence and skill of the operator. It is possible to destroy all tonsillar tissue with electrocoagulation. Some clinicians believe that not all of the tonsillar tissue should be destroyed, but that the destructive action should be limited to the infected tonsillar crypts. The technique just described permits such partial destruction.

## DISEASES OF THE LARYNX

### LARYNGITIS

In the acute stage of laryngitis application of heat may be of value. Heating can be secured from compresses, a photothermal or infra-red source, or from diathermy or short wave apparatus with electrodes placed on either side of the neck. Inhalation of steam, either plain or medicated, is a more direct method of applying heat. In the chronic stage, in addition to heating measures, direct ultraviolet radiation is valuable. These radiations can be administered every other day with increasing dosages.

### TUBERCULOSIS OF THE LARYNX

Tuberculosis of the larynx requires systemic as well as local treatment. Systemic care includes rest in bed, fresh air, artificial pneumothorax, and so forth. Local therapy embraces complete avoidance of talking, local anesthetics (orthoform or anesthesin lozenges), and topical applications of lactic acid. Radiation of the larynx with ultraviolet light is an additional therapeutic agent that has proved of value. This radiation may be applied directly through quartz rods or indirectly by reflection from mirrors. With the latter technique the patient can treat himself with sunlight. A recommended procedure is

auditory canal When the drum opening is too small, sensitizing substances such as eosin or mercurochrome have been instilled into the ear and then radiated

The short wave current affords the most convenient method for the application of heating The condenser electrodes are put on the sides of the head or a coil is placed on the involved side Long wave diathermy may also be employed with the large electrode placed on the cheek opposite to the involved side and the small electrode on the area back of the diseased ear However, the short wave technique is preferred I have observed improvement in some cases of chronic otitis media in response to this form of heating The number of applications necessary to relieve pain and discharge varies from two to thirteen The current is given at comfortable heat tolerance from twenty to thirty minutes every other day (Figs 306, 307)

Friel has described the technique of iontophoresis in the treatment of chronic otorrhea He explains the basis for the application by quoting Leduc who wrote that "the zinc ion is an antiseptic of the first rank and there is no wound or ulcer which cannot be disinfected by its employment provided its surface can be reached by the electrodes One of its peculiarities is that it provokes but little inflammatory reaction"

Cases of chronic inflammations of the middle ear in which suppuration is due to an area of sepsis that is accessible in its entirety, are considered suitable for zinc iontophoresis The surface of the tissue to be treated is first cleansed of debris by means of cotton pledgets soaked in ether After the ear has been cleansed it is irrigated with a solution of zinc sulphate Friel used the following formula

Zinc sulphate	5 gm
Glycerin	60 cc
Water q s ad	1000 cc

This solution is diluted with an equal amount of warm water For cleansing the tympanum and for filling it with solution, an intratympanic syringe is used if the perforation is small The patient should lie on his side with the involved ear exposed An insulated speculum is then inserted into the canal and the ear filled with zinc solution This solution is connected with the positive terminal of the galvanic battery by means of a zinc wire The dispersive electrode is fastened to any other part of the body The current is gradually raised from zero to 5 milliamperes, permitted to flow for ten minutes, and then slowly reduced to zero When the electrodes are removed, a white coagulum can be seen in the depths of the meatus This should not be disturbed If the tissue becomes swollen, Friel blows some boracic acid

## ECZEMA OF THE AURICLE

In general, treatment of eczema of the auricle is like that of eczema in other parts of the body, involving considerations of diet and allergy in addition to topical applications of medicaments. The affected part should be kept dry by the removal of any discharge and by the use of dusting powder and calamine lotion. Ointments made with crude coal tar and zinc oxide are useful. Ultraviolet radiation of the lesion may improve the condition. After the surface has been cleaned thoroughly, the ultraviolet rays are applied, the intensity of the radiations being increased gradually in successive treatments. The uninvolved regions should be protected from the rays. In resistant cases, it may be necessary to use x-rays.

## DISEASES OF THE AURICLE

Erysipelas of the auricle responds dramatically to ultraviolet radiation as it does in other portions of the body. The sulfonamide drugs are now given in conjunction with the ultraviolet radiation. Conductive and conversive heating such as that obtained from compresses and from phototherapy and infra-red lamps have a field of usefulness in the treatment of inflammatory conditions of the auricle such as chondritis, perichondritis, and suppuration. Ultraviolet radiation has also been applied for the treatment of pruritus of the external auditory canal.

## OTITIS MEDIA

Heat in the form of phototherapy or infra-red radiation can be applied in addition to other measures for increasing drainage and sulfonamide medication. If myringotomy is performed, the photothermal applications can be continued. If the acute inflammatory process extends to the mastoid, similar forms of heating are helpful. Indolent mastoid wounds can be stimulated by ultraviolet radiation.

## CHRONIC OTITIS MEDIA

In the treatment of chronic otitis media, systemic causes such as syphilis, tuberculosis, and diabetes, and local factors such as polypi, caries, granulations, and cholesteotoma must be considered. Physical measures offer a number of therapeutic aids: ultraviolet radiation, conversive heating, and iontophoresis. Ultraviolet radiation can be applied systemically, particularly in the treatment of children, and locally. Local application is said to be of value in selected cases of otorrhea, when the perforation in the drum is sufficiently large to admit the rays as they come from the applicator inserted into the

powder into the meatus in order to keep the ear as dry and clean as possible

Beck believes that zinc iontophoresis is indicated in simple types of uncomplicated otorrhea with relatively large central perforations. Cases of otorrhea due to chronic mastoiditis and cholesteotoma and cases of tiny central or peripheral perforations have been benefited in only a very small percentage of cases. From one to five treatments administered at intervals of about a week may be necessary.

#### DEAFNESS

In some cases of deafness converse heating may be applied. Beck describes a technique for medical diathermy with one electrode over the mastoid region of the infected ear and the dispersive electrode placed over the region of the opposite cheek. Three or four treatments a week are administered for from twenty to thirty minutes. If labyrinthian irritation appears, the current strength should be reduced. Beck believes that the treatment is of considerable value in such conditions as chronic adhesive otitis media, but not of value in otosclerosis and labyrinthian deafness following inflammation or fracture.

#### REFERENCES

- BECK, J. C., and GUTTMAN, M. R. Physical therapy in otolaryngology. In Principles and Practice of Physical Therapy. Hagerstown, Maryland, Prior, 1932, Vol II, chap 24.
- BIERMAN, W. Medical Applications of the Short Wave Current. Baltimore, William Wood, 1938, 1942.
- FRIEL, A. R. Electric Ionization. New York, William Wood, 1922.
- FRIEL, A. R. Notes on Chronic Otorrhea with Special Reference to the Use of Zinc Iontophoresis in the Treatment of Selected Cases. New York, William Wood, 1929.
- GIFFORD, S. R. The use of physical therapy in ophthalmology. In Principles and Practice of Physical Therapy. Hagerstown, Maryland, Prior, 1932, Vol II, chap 23.
- HOLLENDER, A. R. Physical Therapeutic Methods in Otolaryngology. St. Louis, Mosby, 1937.
- MAUGHAN, G. H. Ultraviolet radiation as an aid in the prevention of common colds. *Arch Phys Therapy*, 14: 335, 1933.
- MONBRUN, A., and CASTÉRAN, M. La haute fréquence en ophtalmologie. Diathermie médicale. Diathermie chirurgicale. Étincelage. Paris, Masson, 1929.
- RUBENSTEIN, H. J. Personal Communication. March 21, 1942.
- RUSSELL, W. K. Physiotherapy in the common cold and sinusitis. *Brit J Phys Med* 2: 92, 1939.



FIG. 306. Short wave current applied to region of ear. Rigid air-spaced electrodes are disposed laterally.

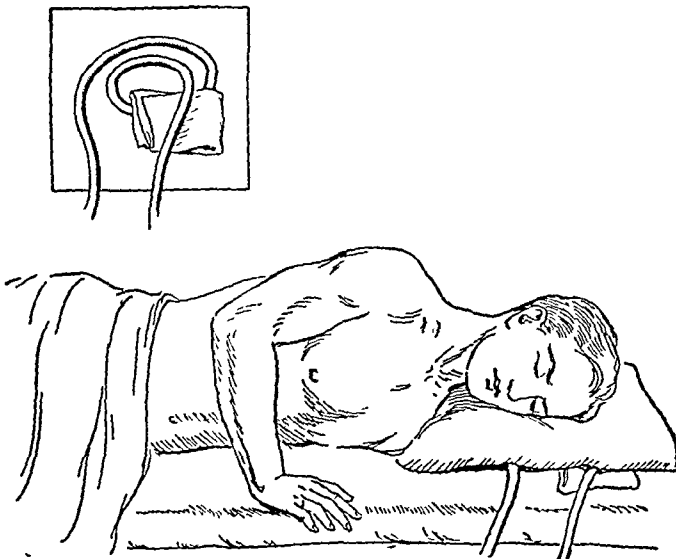

FIG. 307. Short wave current to ear. Coil applied to ear and side of face.

logical findings such as leucocytosis, marked shift to the left, or a very high monocyte lymphocyte ratio

Residence at a sanatorium may be of value not only for the climatic advantages but also for the regime instituted in such establishments. Pulmonary rest produced by artificial pneumothorax commonly forms a part of the present day therapy in tuberculosis. The tuberculous patient who requires rest in bed can be benefited by massage, of both the sedative and stimulative varieties, and also by exercise comprising passive and active motions. Graded active exercise should follow, care being taken to avoid fatigue.

#### EXERCISE IN PULMONARY TUBERCULOSIS

Progressive exercises should be permitted only after the physical signs and symptoms of the disease have become stabilized. Following thoracoplasty, passive exercise may be begun on the fourth or fifth postoperative day and active exercise shortly thereafter. At the beginning, the periods of exercise should last for only a few minutes, and they should not be carried to the point of sweating or dyspnea. It is advised that group exercise not be begun until the third or fourth week after the operation. The character and the severity of the exercise prescribed for a tuberculous patient should be governed by the pulmonary pathological condition. It is just as important for the patient to remain in the hospital for completion of supervised graduated exercise following rest in bed, as it is for surgical patients to remain for surgical dressings and convalescence following operative procedures.

Tuberculosis patients may be classified in three groups

- (1) Those in whom the disease has been arrested and who will be able to pursue gainful occupations
- (2) Those in whom the disease has attained a sluggish quiescence, and who may, to a limited extent, pursue a gainful occupation
- (3) Those in whom the disease is progressive, and who are therefore unable to pursue gainful occupations

#### EXERCISE PROGRAM

Conditioning programs must be adapted to each group. Each patient must be made aware of his condition and understand that he is receiving a course of instruction which is to guide him in his mode of living after leaving the hospital.

During his treatment in the sanatorium, the patient is at first allowed to go to the toilet in a wheel chair. Subsequently, he is permitted to walk one way, and, later, both ways. When first permitted out of bed, he reclines in an

## CHAPTER XXIII

# RESPIRATORY DISEASES

### TUBERCULOSIS

**T**ODAY, CLIMATIC CONDITIONS ARE NOT CONSIDERED as important as they formerly were for the treatment of tuberculosis. Mollard believes that climatic factors have little influence on tuberculosis, and that the beneficial effects which the tuberculous patient derives from a change in environment are attributable to factors other than the climate. For instance, the vagotonic individual with tuberculosis benefits by the stimulation of a high altitude and his condition is aggravated by residence at the sea level. On the other hand, the sympatheticotonic individual may develop attacks of insomnia, palpitation, and nervous excitability while residing in high altitudes but do well at sea level. Audo-Gianotti is of the opinion that patients who have a tendency toward hemorrhage or who are febrile should stay in the relatively non-stimulating climate of low altitudes. Moderate mountain altitudes are suitable for patients with normal temperatures who are able to take walks; and high mountain altitudes, for patients who present *no catarrhal sounds on auscultation and only a minimal tendency toward hemoptysis*. Mayer states: "The lack of accurately controlled observations among certain workers makes it necessary to accept their favorable reports most cautiously. Until contrary evidence is at hand, uncomplicated exudative pulmonary tuberculosis is a contraindication to light therapy. With proliferative or fibrotic pulmonary tuberculosis which may be accompanied by elevation of temperature, sunlight or artificial light if employed at all should be used cautiously." Banyai applied carbon arc radiation to a selected group of sanatorium patients, with general exposure not exceeding thirty minutes a day. He felt that the therapeutic results justified the further application of this treatment in pulmonary tuberculosis and tuberculous pleurisy. He noted that carbon arc irradiation is contraindicated in patients who have a fever, a rapidly advancing type of tuberculosis, multiple or large-sized cavities (more than 3 cm. in diameter), any degree of heart failure, marked general debility, amyloidosis, very rapid sedimentation rate, and unfavorable hemato-

the hospital (2) The classification of the patient should serve as a guide to the program to be followed (3) Since the exercise program of the hospital includes activities designed to maintain physiological health, the same general program should be followed by the patient after he has been discharged

*Walking* Walking is the first real exercise recommended because it can be measured in distance traveled and in the speed attained In view of the necessity for maintaining weight, and the fact that metabolism is increased as a result of exercise, "the T B tread" is advocated in walking This is a slow motion form of walking Fast walking, which increases the frequency and the depth of respiration, may affect the pulmonary pathological condition adversely It is commonly believed that air entering the lungs hastens the cure Pure air is essential for tuberculous patients, but its invigorating effects are due not only to its direct action on the lungs but also to its indirect action through the skin Walking should be done on level terrain as inclines increase the work and cause deep breathing Recreational activities may be added to interest the patient If other forms of exercises are prescribed, the rules to be remembered, according to Brown, are "None if feverish None if blood in sputum None if loss of weight, none if fast pulse Never get out of breath Never get tired Never run Never throw Never hang by the arms Never lift heavy weights No mountain climbing Go slow Exercise regularly and systematically whether rain or shine Walk uphill at start so as to come downhill on return Remember always that you will have to return Rest one hour before and after meals Remember that at the end of every twenty four hours, the body must strike a balance between expenditure and repair which cannot safely be deferred to another day"

*Symptoms and Signs of Over exercise* The symptoms of over exercise or over work are a slight feeling of lassitude, a slight loss of strength, a sense of fatigue, loss of "pep," loss of keenness of appetite, a disinclination to arise after ten hours in bed, and a slight headache The presence of one or more of these signs indicates that the patient has passed the physiological limits of his strength The objective sign is a rise of temperature, which does not usually occur until the following day It is important, therefore, in beginning any form of exercise, to administer it at first on alternate days

#### LUNG ABSCESS, BRONCHIECTASIS, EMPHYSEMA

There are many advocates for the use of short wave diathermy in the treatment of lung abscesses Numerous successes have been reported, particularly by workers abroad For the care of bronchiectasis, postural drainage facilitates evacuation of the purulent secretion Heliotherapy or ultraviolet



easy chair for a period of ten minutes morning and afternoon; this time is gradually increased to an hour. If his general condition shows improvement, he may be considered as a semi-infirm case.

*Semi-infirm Care.* Patients coming from infirmary wards, states Breslin, should continue their general activities. They should be allowed to make beds and take fifteen minute exercises on level ground morning and afternoon. The time of walking is gradually increased to a half-hour every morning and afternoon with recreational and rest periods. The recreational activities which are suggested are reading, writing, occupational therapy in the shop for one hour daily, card-playing, checkers, chess, and the like. Mimeographed exercise charts are provided on which the patient keeps a record of his activities. These are inspected daily by the ward surgeons. They show the month, date, time consumed in exercise, the kind of exercise, pulse, and respiration before and after exercise, and one hour after rest following the exercise. The type of exercise is marked by symbols: for example, 0, no exercise; 1, occupational therapy; 2, going to mess hall; 3, preliminary three minute walk; 4, hiking up to one-half mile; 5, hiking up to one mile; and 6, hiking for two miles or over.

*Final Stage.* In the last stage of the conditioning program the patient is allowed to participate more frequently in the recreational activities, in addition to the exercise program. Occupational therapy is prescribed for one hour in the morning and afternoon. The morning walk on level ground is gradually increased until the distance reached is two miles. When this program of activities can be performed without untoward symptoms, the patient is given a degree of freedom which simulates the mode of life and routine which he is expected to follow when he is discharged from the hospital. He is excused from routine activities and allowed to go to town occasionally. The exercise periods are increased and the rest periods decreased. If there is failure to progress favorably or evidence of retrogression, including reactivation, the progressive exercises should be suspended or, if necessary, discontinued. If the patient responds favorably to the exercise program, he is given a course of instruction, including the regimen to be followed in order to avert relapse, and the precautions necessary to prevent the spread of the disease to others.

Advice given to a tuberculous patient concerning exercise to be performed at home should be governed by the program he has pursued while in the hospital. The following facts should also be kept in mind: (1) No patient can be discharged as cured; the condition is only arrested. A relapse may occur if the patient does not follow the instructions given him when he leaves

apparatus for inhalations are used, in addition to baths and a proper hygienic regimen. At home, the air of the patient's room can be conditioned. Confinement for several days in such air-conditioned rooms has given some measure of relief in a number of patients suffering from bronchial asthma and chronic bronchitis. Some asthmatic patients have secured temporary relief following fever treatments. Abramson has administered epinephrine to asthmatic patients by electrophoresis. When the drug is deposited in the skin in this manner, it is absorbed gradually and therefore the supply is available for a period of time. For the purpose, a solution of 1 per cent epinephrine dihydrogen phosphate buffered with phosphoric acid was employed. The pH of this solution was between 3 and 4. The electrode with a surface area of about 30 sq cm was covered with cotton. Two or three applications were made at each treatment with the current maintained for from ten to fifteen minutes each time.

#### EXERCISES IN ASTHMA

Exercises should take place in front of an open window and at the following time: (a) in the morning before breakfast when the patient is feeling fresh and is least likely to be asthmatic, (b) at night before getting into bed, and (c) at the first sign of an impending attack. Many patients are able to abort their attacks entirely by doing simple exercises gently.

*Essential Considerations* (1) Before commencing the exercise, the patient should blow his nose into a handkerchief.

(2) Each exercise should begin with a short sniff through the nose, followed by a long expiration through the mouth, making a whistling sound by pursing the lips.

(3) When inhaling the patient should learn to hold the upper part of the chest quiescent, so that breathing is performed mainly by the abdominal muscles and the diaphragm. When exhaling, the abdominal wall should contract, sinking in toward the spine. The next breath is drawn into the lungs automatically. All exercises should be finished by breathing out with the abdomen contracted.

(4) The patient should breathe out sufficiently to hear the wheezing noise in the bases of the lungs. This may cause increased wheezing and coughing, but should be persevered with gently. The patient should rest for a minute or two before each exercise.

(5) To begin with, the exercises should be done very gently with plenty of rest. When the patient states that he feels "tight on the chest" he should do them in the reclining position, lying back on the pillows with the knees

radiation may be of value. In empyema, surgical incision is followed by irrigation or continuous suction. A special exercise consisting in blowing water from one bottle to another helps to restore function of the partially collapsed lung (Fig. 308).

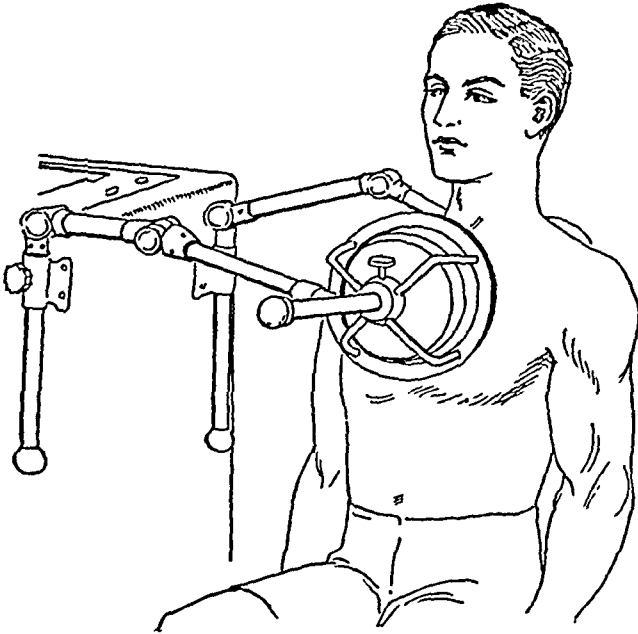

FIG. 308. Short wave current applied to the thorax by means of rigid electrodes surrounded by guards.

#### LOBAR PNEUMONIA

Diathermy applied by means of electrodes to the chest has been shown to be of value in lobar pneumonia. Stewart reported a large series of cases in which the temperature dropped by lysis following diathermy treatment, and we have observed similar results in patients under our care. Pleural pains were eased and the respiratory effort diminished. Treatments are administered for periods of one-half to one hour and repeated three times during the twenty-four hours. The newer methods of treating pneumonia, such as the sulfonamides, specific sera, and oxygen, have rendered converse heating measures less necessary, but they are still useful adjuvants, particularly where resolution is delayed.

#### ASTHMA

A change to a favorable climate may bring relief to patients with asthma. A suitable health resort will provide not only good climatic conditions, but also physical measures adapted to these patients. In European spas, special

The back should be rounded. Then, raise the body, gradually breathing in until the body is erect, with the shoulders lowered, the arms slightly drawn back and the back straight. When beginning to breathe out, the head relaxes forward first, then the shoulders and arms. With small children small bits of paper can be placed on the floor to be blown upon to encourage breathing out.

*Shoulder Loosening Exercises for Children* ("Windmills for Children") Standing with the feet apart, both arms are circled so that they cross each other coming upward in front of the face. The circles thus intersect each other.

*Relaxing Exercises* Sitting with feet apart, at first shrug shoulders slightly. Relax shoulders and let arms hang heavily. Later, shrug shoulders and tighten arm muscles while pressing head back. Then completely relax all muscles that are tense, allowing head and shoulders to sag. The shrugging and tightening should be done quickly (count 2). The relaxing should be maintained twice as long (count 4).

*Advanced Exercises* Abdominal trunk exercises with breathing. Lying on back, knees bent up, arms at sides, breathe out while rising and bending forward to place the head between the knees. Breathe in while sinking back. Rest for a moment while breathing out quickly and contracting abdominal muscles. Then breathe in before repeating the exercise. While resting back, the breathing is of normal rate, but only the upper part of the abdomen and lower ribs move. In bending forward, the back is rounded and the head is just above or between the knees, so that the abdominal muscles can be fully contracted.

*Loosening Exercises (Head and Shoulder Side Bending)* Standing with feet apart, fists clenched and resting at either side of head on top, elbows well back, bend head and shoulder over, carrying the arm down to the side. Straighten and carry the arm back to the starting position. Repeat with a quick swing down of the arm three times to one side, then three times to the other side with the other arm moving. While bending to the right, use the left fist well over to the right. Note that it is only the head and shoulders that move.

*Advanced Trunk Side Bending with Breathing* Sitting with the feet well apart, right hand at ribs at side of chest, begin to breathe out, at the same time bending to the right side. Then bend over to the other side while breathing in. Bend slowly over again to the right side, breathing out. After six bends to the right, breathing out, change hands and bend to the left side, while breathing out, so that the base of the left lung is fully used. The

drawn up comfortably. He may also lie on the side with the knees bent comfortably.

(6) The preliminary exercises should be practiced until they are done perfectly before going on with the advanced exercises.

(7) It is well to time the interval during which the patient can maintain the exhalation. On no account must he take a deep breath first. At the beginning, he will be able to sustain the exhalation for but a few seconds; later, he may be able to sustain the whistle for from forty to sixty seconds.

*Abdominal Breathing.* (1) Lying with knees drawn up, with hand on upper abdomen, feel fingers sinking in on breathing out (contracting abdominal muscles). Then, relax abdominal muscles while taking a short breath, taking care not to let the upper part of the chest move on breathing in.

(2) Sitting with back supported, with hands over lower ribs, wrists well back and fingers pointed forward, begin to breathe out while contracting the abdominal muscles. Squeeze the ribs at the end of the expiration to force out the last possible bit of air. Then, relax the abdominal muscles and expand the lower ribs while taking a short breath. The shoulders must be lowered and the arms kept relaxed until the final squeeze. The aim of this exercise is to expand and contract the thorax in the region of the lower ribs as well as to extend and contract the upper abdominal muscles, so as to use to the fullest power the region of the bases of the lungs.

(3) Abdominal breathing for small children. Lying with knees drawn up, hands loosely at sides, slowly breathe out while making a small object (such as a paper boat or celluloid fish) sink down "between waves." Then relax abdominal wall while taking a short breath so that the toy comes up on "crest of wave." The upper chest must not move in either position.

*Loosening Exercises for Shoulders (Elbow Circling).* Sitting with feet apart, hands to shoulders, and elbows held out from the sides level with the shoulders, carry the elbows slightly forward, then upward, then backward and downward. Repeat quickly six to eight times. Then, rest, dropping arms to sides to relax shoulders. Note that the back should be held straight, the lower part being pressed back (against a doorway edge if necessary) and with a pad in the lower part of the back to maintain opposition.

*Blowing Exercises for Children.* While standing, blow bits of paper or small balls across the table, first through the mouth, later through the nose. There must be one long blow, not many short ones.

*Forward Bending.* Sitting with feet apart and arms hanging loosely at sides, bend the body forward until the head is between the knees (or above them) while breathing out and fully contracting the abdominal muscles.

artificial respiration has been combined with the inhalation of mixtures of carbon dioxide and oxygen

## REFERENCES

- ABRAMSON, H A Comparisons of treatment of severe asthma by electrophoresis of epinephrine with other methods *Arch Phys Therapy*, 21 261-266, 1940
- AUDO-GIANOTTI, G B Climatotherapeutics in pulmonary tuberculosis *Med contemp (Torino)*, 4 176, 1938
- DELTHIL, P, and PEUTEUIL, J Treatment of whooping cough with ultraviolet rays *J de radiol et d'electrol*, 23 385-389, 1939
- KERNAN, J D Electrocoagulation in bronchogenic conditions *Arch Phys Therapy*, 19 38-43, 1938
- KERNAN, J D Galvanism in treatment of bronchial strictures *Arch Phys Therapy* 20 739-744, 1939
- MOLLARD, H Principles of climatology in pulmonary tuberculosis *Ann Inst d'actinol*, 12 73-80, 1938
- STEWART, H E *Physiotherapy, Theory and Clinical Applications* Ed 2 New York, Hoeber, 1929

bending is high up and only over the waist. The hand presses firmly toward the end of breathing out, so that the air is squeezed out of the lung. On breathing in, the side of the chest is pressed out against the hand.

*Posture Correcting and Breathing Exercises (Advanced Trunk Forward-Bending).* Standing with whole of back, shoulders, and head against corner of wardrobe or doorway edge, feet six inches away from the wall, bend down slowly, head, then shoulders, then back, while breathing out. The arms hang limply. Raise the body while breathing in, pushing the lower part of the back first against the door edge, then middle part, then shoulders, then head. Holding head, shoulders and upper part of back and hips firmly against the edge, breathe out quickly, contracting abdominal muscles so that the lower part of the back is flattened against the edge too. Take a small breath before repeating.

#### WHOOPING COUGH

Delthil reports that general body irradiation with ultraviolet during attacks of coughing usually rapidly produces a favorable effect in the treatment of whooping cough. He has found that clinical improvement runs parallel with the intensity of the erythema and actinic pigmentation produced. He states that actinotherapy should not be used in the beginning of the disease, but during the period in which there are attacks of coughing and vomiting. Treatments are started with the production of only a slight erythema; and gradually increased in strength during the administration of from four to twelve treatments.

New growths in the bronchi can be destroyed by coagulation. Kernan reports cures of adenomata after three or four treatments given at fortnightly intervals. Tuberculous tumors are also amenable to coagulation. Kernan calls attention to the danger of damaging the bronchial wall by too extensive coagulation, with consequent damage to the blood vessels and to the structures of the mediastinum. He dilates bronchial strictures with negative galvanism, using current of about 3 milliamperes, applied through a copper-tipped electrode.

#### ARTIFICIAL RESPIRATION

Artificial respiration is a physical measure which has an important place in resuscitation from gas poisoning, morphine poisoning, drowning, electric shock, and in poliomyelitis. Manual measures for artificial respiration have been widely described. Automatic apparatus has been constructed for the treatment of conditions like poliomyelitis. Under special circumstances,

mercury vapor lamps as well as carbon arc lamps are used for general body radiation. For radiation of a localized area, ultraviolet generators, cooled by running water or by air under pressure, and low pressure quartz mercury vapor lamps are more efficient. In recent years the so-called "cold quartz lamp" has come into wide use among dermatologists. Time required for treatment is diminished because of the rapid stabilization of this apparatus and because its relative lack of heat permits it to be applied close to the skin surface. Its radiation is largely monochromatic, about 95 per cent at 2537 Angstrom units. This wavelength causes desquamation with relatively little erythema and tanning. This lamp is not, however, as suitable for the stimulation of vitamin D production as are the types of apparatus which also emit radiation in other sections of the ultraviolet spectrum.

Most of the lamps which are sold directly to the public do not produce radiation containing the shorter ultraviolet wavelengths. Because of their limited spectrum and limited energy, they are not suitable for office or hospital use, but for additional treatment at home under the direction of the physician they are useful. The intensity of the radiation to be applied is governed by the apparatus, the individual, and the disease to be treated. While radiation measuring devices are available, the simplest procedure is to determine the erythema time of each patient. Determination of the erythema dose is particularly important when there is danger of causing exacerbation of inflammation, as in eczema and psoriasis. Many persons are peculiarly sensitive to ultraviolet radiation. Such persons must avoid direct exposure to the sun, if symptoms of discomfort or such skin manifestations as herpes simplex or sailor's or farmer's skin with its possible progress to keratoses, and later to malignant growths, are to be prevented. Susceptibility to ultraviolet radiation is increased by ingestion of substances such as the sulfonamides and barbiturates, and also by substances sprayed on the skin, such as perfumes and oil of bergamot.

In describing the indications for the use of ultraviolet radiation in dermatology, MacKee and Cipollaro state that "it appears to be the general impression in the medical profession and among lay persons that ultraviolet radiation is of great value in dermatology. There is sufficient evidence to justify the belief that ultraviolet radiation is a valuable remedy for erysipelas and for certain types of cutaneous and subcutaneous tuberculosis. It is reasonably well established that ultraviolet radiation is at times useful either alone or as an adjuvant in the treatment of acne vulgaris, adenoma sebaceum, pityriasis rosea, parapsoriasis, psoriasis, telangiectasia, indolent ulcers and wounds, and port wine stains."



## CHAPTER XXIV

# DERMATOLOGICAL DISEASES

**I**N RECENT YEARS PHYSICAL THERAPEUTIC PROCEDURES have made possible great advances in the treatment of diseases of the skin. A good review of the subject is to be found in "The Principles and Practice of Physical Therapy," by MacKee and Cipollaro.

### PHYSICAL MEASURES EMPLOYED IN DERMATOLOGY

The physical measures that have been found useful in dermatological conditions are: the high frequency currents employed for destructive purposes (surgical diathermy), the galvanic current for its iontophoretic and electrolytic effects, ultraviolet radiation, hydrotherapy, massage, and solid carbon dioxide.

#### HIGH FREQUENCY CURRENTS

Fulguration, electrodesiccation, electrocoagulation, and the cutting currents applied with the techniques described in preceding chapters, all have their place in the treatment of dermatological conditions. The pathological character and the extent of the lesions determine which of these techniques should be employed in a given case.

#### GALVANIC CURRENT

The destructive action of the galvanic current is utilized particularly for the permanent removal of superfluous hair. The ability of the current to convey ions provides a means of transferring chemicals into the superficial layers of the skin; for example, for the introduction of copper in the treatment of fungus diseases.

#### ULTRAVIOLET RADIATION

Ultraviolet radiation was first used by Finsen to cure lupus vulgaris. The source of the radiation he used was the carbon arc lamp, and this type of lamp, somewhat modified, is still in use in Europe. In this country, air-cooled

rucae This method is advocated in the treatment of children Some filiform warts can be readily removed by electrolysis This is accomplished by transfixing the base of the growth with a needle and permitting the current to flow until the growth changes its color There is no resultant scarring

#### KERATOSES

Keratoses may be destroyed by electrodesiccation, electrolysis, solid carbon dioxide, or the actual cautery When the possibility exists that such growths may serve as a starting point for skin cancer, the adjacent healthy tissue should be included in the region destroyed This is done by "circumvallating" the lesion with multiple punctures of the needle, through which the coagulating current is sent The growth within the coagulated area is excised by the cutting current Such lesions can also be excised with a scalpel, and the area subsequently exposed to radium When keratotic lesions may develop following the application of x ray and radium, they should be treated as potentially malignant Telangiectasia occurring secondarily to radiodermatitis can be destroyed by electrolysis, electrodesiccation, or the Kromayer lamp applied with or without compression The latter method is not considered so effective as the first two

#### LEUCOPLAKIA

Leucoplakic lesions can be removed by electrodesiccation or coagulation

#### NEVI

For the destruction of nevi, the procedure to be used depends on the type of nevus in a given case Spider nevi are most effectively destroyed by electrolysis of the central region Nevus flammeus or port wine stain frequently cannot be satisfactorily removed by any of the methods now available Repeated applications of solid carbon dioxide are thought to offer the best possibility of success, but the mottled effect that sometimes results from the blanching of these lesions may look worse than the original blemish The Kromayer lamp applied with compression at repeated intervals for a long period of time may cause the disappearance of pink nevi and a diminution in the color of the redder ones Angiomas are best treated with radium Radium packs are particularly suited for removal of cavernous angiomas occurring in children These applications are painless and require no anesthesia It is also possible to destroy angiomas by electrodesiccation and electrocoagulation

## HYDROTHERAPY

Baths and compresses are media used for the transfer of heat, cold, and medicaments such as boric acid, aluminum acetate, and lead acetate. Moist applications are helpful in the treatment of infections, cellulitis, folliculitis, boils, carbuncles, and acute eczema. Bran, oatmeal, and starch are added to baths for the treatment of such conditions as pruritus, urticaria, and chronic eczema. The addition of sodium bicarbonate or magnesium sulphate to the bath may increase its antipruritic value. Sulphur, sea salt, and pine extracts are other preparations frequently added to baths. Severe cases of pemphigus can be treated with the continuous bath in which potassium permanganate is dissolved (about 10 gm. to the usual 40-gallon bath).

## MASSAGE

Massage is employed to reduce scars and keloids, and to stimulate the circulation of the scalp and of the face. It can also be applied in those cases in which inadequate circulation is responsible for the persistence of the pathological condition of the skin; for instance, in chronic eczema of the extremities.

## COLD

Cold, so intense that it causes local destruction of tissue, is readily produced by the application of solid carbon dioxide. This "dry ice" can be held in a special applicator such as that of Lortat-Jacob, or in some simple cold-insulating substance, or it may be mixed with acetone and sulphur and applied as a slush.

## VERRUCAE

Most varieties of warts can be readily destroyed by electrodesiccation. Local anesthesia makes it possible to perform the operation thoroughly. The desiccated tissue should be removed with a curette as the electrical destruction proceeds, in order to make certain that all abnormal tissue is removed. Certain warts, particularly the hard, flat variety, cannot be satisfactorily removed by electrodesiccation; some of these can be destroyed with electrocoagulation, but the possibility of a resulting scar is definitely greater than with electrodesiccation. After desiccation, the destroyed tissue separates away within a period of two or three weeks and usually there is little, if any, scarring. Solid carbon dioxide applied with pressure until the lesion turns white (in about twenty seconds) affords another good technique for the removal of ver-

## ROSACEA AND RHINOPHYMA

In rhinophyma, portions of the tissue can be removed by the cutting current and the region then desiccated. Small involved areas can be desiccated directly. Small blood vessels may be destroyed by electrolysis.



FIG 309 Epilation by means of diathermy

## HYPERTRICHOSIS

Electrolysis is the procedure most commonly used for removal of superfluous hair. However, the high frequency current has its advocates, who believe that this method is more rapid than electrolysis.

The technique for epilation by electrolysis is described on page 442. The technique for epilation by means of diathermy is shown in Figure 309. Patient and operator assume positions permitting maximum relaxation. The active electrode is a fine, platinum needle. The dispersive electrode is a metal plate which partially encircles the forearm. A finger switch on the active electrode permits control of the current. A diathermy machine made for the purpose is adjusted so that about 20 to 30 milliamperes of current are employed, the actual quantity of current used should be governed by the clinical results. The needle is inserted into the region of the follicle before the current is turned on, and should not be removed until the current has been discontinued. The duration of current flow is but a fraction of a second. The patient's discomfort may be minimized by pinching the skin before the

## MOLES

The common mole which usually contains a few thick hairs or the mouse-skin mole which holds a large number of fine hairs can be destroyed by electrodesiccation or solid carbon dioxide. Coarse hairs, when they exist, are first removed by electrolysis. This may cause sufficient fading of the lesion to make it unnecessary to use any further measure. A word of caution is necessary regarding the blue-black smooth moles without hair: sarcomata have developed in such lesions when insufficient treatment has resulted in stimulating them rather than in destroying them. They should be left alone, or widely excised with the scalpel or thoroughly destroyed by surgical diathermy.

## VARIOUS BENIGN GROWTHS AND HYPERTROPHIES

The possibility that a keloid may recur after it is removed by a scalpel or electric surgery, makes it advisable to remove these growths with x-ray or radium. Small keloids can be treated by galvanism, carried out by connecting the active electrode, soaked in saline solution, to the negative pole. Iontophoresis with a 1 per cent solution of potassium iodide (on the negative electrode) has also been recommended for the destruction of keloids. Small keloids are also said to be diminished by massage applied over a long period of time.

Callosities can be excised with a scalpel or with the cutting current; or they can be destroyed by electrodesiccation, solid carbon dioxide, and roentgen rays or radium. Electrodesiccation is a good method for the removal of fibromas, granuloma pyogenicum (with curettage), and of xanthelasma palpebrarum. For the latter condition, applications of trichloroacetic acid are considered simpler and equally effective. I prefer to use electrodesiccation because the involved tissues can be destroyed with greater exactness. Xanthoma can be destroyed with solid carbon dioxide. Adenoma sebaceum can be removed by electrodesiccation, solid carbon dioxide, electrolysis, or blistering doses of ultraviolet radiation. For scleroderma, massage and iontophoresis with mecholyl and galvanic baths have been advised.

## CYSTS

Cysts are best removed by dissection with scalpel and scissors. An infected sebaceous cyst may be difficult to enucleate surgically. Such cysts may be incised, the contents evacuated, and the lining destroyed by electrodesiccation. (The needle electrode is inserted through the opening into the cyst.) Thorough desiccation is necessary for permanent eradication. Small, non-infected cysts may be treated in a similar manner.

## ROSACEA AND RHINOPHYMA

In rhinophyma, portions of the tissue can be removed by the cutting current and the region then desiccated. Small involved areas can be desiccated directly. Small blood vessels may be destroyed by electrolysis.



FIG. 309 Epilation by means of diathermy

## HYPERTRICHOSIS

Electrolysis is the procedure most commonly used for removal of superfluous hair. However, the high frequency current has its advocates, who believe that this method is more rapid than electrolysis.

The technique for epilation by electrolysis is described on page 442. The technique for epilation by means of diathermy is shown in Figure 309. Patient and operator assume positions permitting maximum relaxation. The active electrode is a fine, platinum needle. The dispersive electrode is a metal plate which partially encircles the forearm. A finger switch on the active electrode permits control of the current. A diathermy machine made for the purpose is adjusted so that about 20 to 30 milliamperes of current are employed, the actual quantity of current used should be governed by the clinical results. The needle is inserted into the region of the follicle before the current is turned on, and should not be removed until the current has been discontinued. The duration of current flow is but a fraction of a second. The patient's discomfort may be minimized by pinching the skin before the

needle is inserted. Each hair should be removed by a forceps directly after it has been treated. If the hairs do not come out easily, the application of current has been inadequate and should be repeated. This diathermy technique permits more rapid removal of hair than does the galvanic current technique. No visible scarring occurs if the current is adjusted to the proper amount.

#### EPITHELIOMA

Basal cell epitheliomas are relatively benign tumors, which may be satisfactorily destroyed by electrocoagulation. Squamous cell epitheliomas being malignant in character, should be widely destroyed by means of electrocoagulation or excision with a cutting current performed early, and the site subsequently treated with x-rays or radium.

#### FURUNCLES AND CARBUNCLES

Furuncles and carbuncles can be satisfactorily treated with electrodesiccation accomplished by inserting a needle into the central region of the infection. Both x-ray and short wave current also appear able to abort these infections if applied sufficiently early. The short wave current if used too energetically may cause the infection to spread. Where drainage exists, heating measures such as radiant energy and mild applications of the short wave current facilitate healing. The local use of ultraviolet radiation does seem to be of value.

#### SKIN TUBERCULOSIS

The therapeutic value of ultraviolet radiation in tuberculous diseases of the skin was first established by Finsen in the treatment of lupus vulgaris. He employed the light from a carbon arc source concentrated by means of quartz lenses. Applications were made with pressure to dehematize the area. Circulating water served to cool the applicator. A less cumbersome and less expensive apparatus which can be applied in a similar fashion is the fluid-cooled Kromayer lamp. With this lamp several times the erythema dose is given at each treatment. After the reaction has disappeared the treatment is repeated. General body radiation with ultraviolet rays enhance the effectiveness of local applications. Treatments must be administered over a period covering many months before the lesions heal. A more rapid response may be secured by use of destructive agencies such as electrodesiccation, electrocoagulation, or cauterization.

In lupus erythematosus, ultraviolet radiation is contraindicated, as it may

cause rapid spread of the lesion. Patients suffering from this disease are placed in rooms where only red light is permitted to enter, in order to avoid exposure to the photo-active portions of the spectrum.

In official tuberculosis, exposure to ultraviolet radiation may result in marked improvement. Localized lesions can be destroyed by electrodesiccation, electrocoagulation, or cauterization. Local ultraviolet radiation is not considered of value in tuberculosis verrucosa cutis, erythema induratum (Bazin's disease), sarcoid, granuloma annulare, and tuberculids. These lesions can be destroyed by surgical diathermy. The hygienic care should include general body exposure to small doses of ultraviolet radiation.

#### ACNE VULGARIS

Dermatologists differ in their estimation of the value of ultraviolet light in the treatment of acne vulgaris. While not as effective as x ray radiation, it possesses certain advantages. These are enumerated by Zeisler, who says "When used over a prolonged period it is far safer than x ray and can be administered without fear of relapsing cases. It can be combined with topical stimulating and antiseptic treatment. In large doses it is of definite value in the residual scarring and pitting. The absence of possible late sequelae and freedom from late complications are important advantages over x ray therapy."

Zeisler has observed that his results with ultraviolet light are better if preceded by a short series of x ray treatments, of four to six doses of one-eighth to one-quarter skin unit. In most cases of acne of the face he favors irradiation in suberythema doses with the water-cooled Kromayer lamp. He found that the effect of ultraviolet is increased by preliminary topical application of a 2 per cent solution of iodine in chemically pure benzol. In more deeply seated nodular and pustular lesions he advises painting the involved area with Cutler's solution (equal parts of tincture of iodine, phenol, and chloral hydrate). The technique which I have used is to cause a marked erythema with peeling. After this reaction has faded, I repeat the radiation in the same manner.

#### ECZEMA

The value of ultraviolet radiation in eczema has been summarized by MacKee and Cipollaro. "Many dermatologists claim that ultraviolet rays are useful for many varieties of eczema and in selected cases this is possibly true, but, in general, American dermatologists agree that ultraviolet radiation is not of much value in this disease. It is not indicated in acute eczema. Gen-



eral body irradiation may be of some value in selected cases of chronic eczema. At times, any agent that will evoke hyperemia in a patch of chronic squamous eczema will hasten recovery, and ultraviolet radiation may be used for this purpose."

Ultraviolet radiation is said to be of occasional value in eczema seborrheicum, eczema hemostaticum, and in neurodermatitis. Starting with a suberythematous dose, the strength of the doses is gradually increased. Better results are seen following the application of x-rays in the forms of eczema just mentioned and also in eczema venenatum, dermatophytosis, and infectious eczematoid dermatitis.

In generalized neurodermatitis, mild fever treatments may cause a temporary regression of the lesion. Vacationing in some place removed from home, with its concomitant relaxation, exposure to the sun's rays, and so forth, may help patients with neurodermatitis.

#### PSORIASIS

The fact that many patients suffering from psoriasis reported the temporary disappearance of their lesions after they had exposed the involved parts to the summer sun, naturally led to the use of ultraviolet radiation in the treatment of this disease. In many instances these applications have been followed by temporary improvement; in others, they have not been of any value. In some types of psoriasis, especially the acute forms, vigorous ultraviolet radiation is cautioned against because of the danger that it may be followed by the development of dermatitis exfoliativa. The radiation is administered in gradually increasing doses. Local lesions can be sensitized by means of coal tar in the manner recommended by Goeckerman. He applies an ointment of 1 to 5 per cent crude coal tar to the psoriatic patches. The proper percentage of coal tar is incorporated in about the equivalent amount of Lassar's paste. This ointment is applied on the night preceding the treatment and is permitted to remain in contact with the skin until the next day. The excess of ointment is then removed with olive oil. A thin film, enough to look like a brown stain, is allowed to remain. The patches are then exposed to the radiation, beginning with a small dose to avoid any uncomfortable reaction. This procedure is repeated daily. The intensity of the radiation is gradually increased to develop a tan. This technique has been followed by remissions for periods of several months to several years. Some types of parapsoriasis have been said to be improved by ultraviolet rays.

## ERYSIPELAS

Erysipelas responds dramatically to massive doses of ultraviolet radiation. The technique is to apply at least ten times the erythema dose to the lesion as well as to about an inch of the surrounding normal appearing skin. The usual response is marked lowering of the systemic temperature and regression of the inflammation within twenty four hours. If such rapid progress does not ensue, another similar radiation is administered the next day. I follow the ultraviolet radiation with a continuous heat application from a small photothermal lamp held at a distance to give a comfortable sensation of warmth. I believe that this technique is particularly indicated in the treatment of regions such as the scalp where a thick covering of hair may interfere with the ultraviolet administration. With the advent of sulfanilamide and similar compounds, the clinician is more likely to try chemotherapy first. Where failure follows the use of such medication, as it occasionally does, I have not hesitated to apply ultraviolet radiation even though the drug is still present in the blood. The photosensitizing influence of these compounds may enhance the effect of local radiation.

## ALOPECIA

Ultraviolet radiation is considered an adjuvant in the treatment of alopecia areata and alopecia praematura. It is used to cause active hyperemia. This response is said to be secured equally well by other methods of irritation such as the application of phenol.

## PITYRIASIS ROSEA

As pityriasis rosea is self limited, it is difficult to evaluate remedies applied for it. A mild erythema dose of ultraviolet radiation hastens the disappearance of the lesion.

## FUNGUS INFECTIONS

Iontophoresis with copper sulphate solution may yield good results in fungus infections. When the feet are to be treated, they should be immersed in basins containing 0.2 per cent solution of copper sulphate, and the hands inserted into the saline solution basins, which are connected to the negative terminal. Copper electrodes are immersed in the copper solutions and connected to the positive terminal. Three to ten milliamperes of current are applied once or twice during the week. Harpuder employs iontophoresis with silver nitrate solution (1 per cent) in fungus infections of the skin. The

treatment is carried out for from fifteen to twenty minutes with a current concentration of 0.25 to 0.5 milliampere per square centimeter. The limited value of ultraviolet radiation in the treatment of fungus infections may be explained by its slight penetrative effect. Scholtz has shown that the bactericidal power of ultraviolet radiation cannot influence those diseases which extend beyond the epidermis or corium.

Dermatological conditions in which ultraviolet radiation is considered to be of doubtful value include sycosis vulgaris, leucoderma, pemphigus, and dermatitis herpetiformis.

#### REFERENCES

- FINSEN, N. R. In E. Mayer: *The Curative Value of Light*. New York, Appleton, 1932.
- GORCKEPMAN, W. H. The treatment of psoriasis. *Northwest Med.*, 24 : 229-231.
- HARPUDE, K. Electrophoretic therapy. *New York State J. Med.* 38 : 176-179, 1938.
- MACKEE, G., and CIPOLLARO, A. Treatment of skin diseases with radiation. In *Principles and Practice of Physical Therapy*, Hagerstown, Maryland, Prior, 1932, Vol. II, chap. 4.
- MACKEE, G., and CIPOLLARO, A. Physical therapy in dermatology. In *Principles and Practice of Physical Therapy*. Hagerstown, Maryland, Prior, 1932, Vol. I, chap. 18.
- MACKEE, G., and CIPOLLARO, A. Treatment of skin diseases by physical methods other than radiation. In *Handbook of Physical Therapy*. Chicago, American Medical Association, 1939.
- MACKEE, G., and CIPOLLARO, A. Ultraviolet therapy in dermatology. In *Handbook of Physical Therapy*. Chicago, American Medical Association, 1939.
- SCHOLTZ, J. R. Ultraviolet in skin infections. *Arch. Phys. Therapy*, 19 : 419-426, 1938.

# APPENDIX

## APPARATUS

IT IS DIFFICULT TO ANSWER THE QUESTION WHICH naturally arises in the mind of the prospective purchaser of physical therapy apparatus, "What machine shall I buy?" The various makes of each type of apparatus are so numerous as to make it impossible for any one individual or group of individuals to give advice based on personal experience. The Council on Physical Therapy of the American Medical Association accepts or rejects physical therapy apparatus in accordance with standards which it has set up. Apparatus should be purchased which has received the acceptance of the Council. Information on this point can be secured by writing to the Council on Physical Therapy, American Medical Association, 535 North Dearborn Street, Chicago, Illinois.

The following specifications for physical therapy equipment, issued by the Department of Hospitals of the City of New York, may serve as a guide in the purchase of apparatus. These specifications were adopted on the recommendation of a committee consisting of physicists and specialists in physical therapy. It should be distinctly understood that apparatus which does not meet these specifications may nonetheless be good. Machines now constructed by reputable companies are usually well made. As a rule, the physician may purchase them with reasonable certainty that they will serve him efficiently for many years.

### SPECIFICATIONS FOR PHYSICAL THERAPY EQUIPMENT

#### THE CITY OF NEW YORK DEPARTMENT OF HOSPITALS

##### GENERAL

##### *Intent and Scope*

These specifications describe physical therapy apparatus and accessories for use in the City Hospitals and other institutions.

No bid will be considered unless the firm submitting the bid can qualify to the following conditions, and it shall certify to its ability to meet them upon request within five (5) days.

treatment is carried out for from fifteen to twenty minutes with a current concentration of 0.25 to 0.5 milliampere per square centimeter. The limited value of ultraviolet radiation in the treatment of fungus infections may be explained by its slight penetrative effect. Scholtz has shown that the bactericidal power of ultraviolet radiation cannot influence those diseases which extend beyond the epidermis or corium.

Dermatological conditions in which ultraviolet radiation is considered to be of doubtful value include sycosis vulgaris, leucoderma, pemphigus, and dermatitis herpetiformis.

#### REFERENCES

- FINSEN, N. R. In E. Mayer: *The Curative Value of Light*. New York, Appleton, 1932.
- GOECKERMAN, W. H. The treatment of psoriasis. *Northwest Med.*, 24 : 229-231.
- HARPUDEK, K. Electrophoretic therapy. *New York State J. Med.* 38 : 176-179, 1938.
- MACKEE, G., and CIPOLLARO, A. Treatment of skin diseases with radiation. In *Principles and Practice of Physical Therapy*, Hagerstown, Maryland, Prior, 1932, Vol. II, chap. 4.
- MACKEE, G., and CIPOLLARO, A. Physical therapy in dermatology. In *Principles and Practice of Physical Therapy*. Hagerstown, Maryland, Prior, 1932, Vol. I, chap. 18.
- MACKEE, G., and CIPOLLARO, A. Treatment of skin diseases by physical methods other than radiation. In *Handbook of Physical Therapy*. Chicago, American Medical Association, 1939.
- MACKEE, G., and CIPOLLARO, A. Ultraviolet therapy in dermatology. In *Handbook of Physical Therapy*. Chicago, American Medical Association, 1939.
- SCHOLTZ, J. R. Ultraviolet in skin infections. *Arch. Phys. Therapy*, 19 : 419-426, 1938.

# APPENDIX

## APPARATUS

IT IS DIFFICULT TO ANSWER THE QUESTION WHICH naturally arises in the mind of the prospective purchaser of physical therapy apparatus, "What machine shall I buy?" The various makes of each type of apparatus are so numerous as to make it impossible for any one individual or group of individuals to give advice based on personal experience. The Council on Physical Therapy of the American Medical Association accepts or rejects physical therapy apparatus in accordance with standards which it has set up. Apparatus should be purchased which has received the acceptance of the Council. Information on this point can be secured by writing to the Council on Physical Therapy, American Medical Association, 535 North Dearborn Street, Chicago, Illinois

The following specifications for physical therapy equipment, issued by the Department of Hospitals of the City of New York, may serve as a guide in the purchase of apparatus. These specifications were adopted on the recommendation of a committee consisting of physicists and specialists in physical therapy. It should be distinctly understood that apparatus which does not meet these specifications may nonetheless be good. Machines now constructed by reputable companies are usually well made. As a rule, the physician may purchase them with reasonable certainty that they will serve him efficiently for many years.

### SPECIFICATIONS FOR PHYSICAL THERAPY EQUIPMENT

THE CITY OF NEW YORK  
DEPARTMENT OF HOSPITALS

#### GENERAL

##### *Intent and Scope*

These specifications describe physical therapy apparatus and accessories for use in the City Hospitals and other institutions.

No bid will be considered unless the firm submitting the bid can qualify to the following conditions, and it shall certify to its ability to meet them upon request within five (5) days.

That it has in operation, or is a dealer for, a factory engaged in the manufacture of physical therapy apparatus or accessories which it proposes to furnish and that it is suitably equipped with facilities for making all the tests required by the City. That it has been engaged in the manufacture of physical therapy apparatus or accessories of the type or similar type or improvements thereof that is bid upon, for at least three years preceding date of advertisement of bid.

That it has in operation and has had at least twelve months prior to the time of bidding, a service department. This is to be within a radius of fifty miles of the Municipal Building, Borough of Manhattan. It shall be suitably equipped to render prompt service and shall have a supply of spare parts for replacement.

### *Contractor's Obligation*

Physical therapy apparatus and accessories delivered shall be demonstrated by the contractor under actual working conditions.

The contractor shall replace, without cost to the City, any physical therapy apparatus or accessories, or parts that develop defects due to faulty material or workmanship (electronic tubes and glassware excepted) within twelve months after acceptance of the installation of the items supplied.

In case of failure of the contractor to make good any defects of the equipment within the guarantee period fifteen days time to be specified in a written notice from the City to the contractor, the City may have the equipment placed in satisfactory condition charging the cost thereof to the contractor, who agrees to repay such cost to the City.

The work shall include furnishing, erecting, installing, and testing of all equipment, apparatus and accessories supplied. Damages caused by the contractor to existing work shall be repaired and replaced by him at no expense to the City.

Unless otherwise indicated in the schedules, it is presumed that the City of New York has provided adequate supply outlets, plumbing and carpenter work to properly install, operate and satisfactorily test the equipment and accessories bid upon. The successful bidder shall install and connect the fixed equipment furnished by him at the locations indicated on the drawing or blue print submitted with request for bid by the City of New York. Should the apparatus or equipment of a particular manufacturer necessitate special wiring, plumbing or other work for its proper installation, the manufacturer should so state in his bid and consider this work as part of the installation.

These changes shall be indicated on revised drawing or blue prints made to a scale of  $\frac{1}{2}$ " to the foot covering all such changes required. All installations are to be made in accordance with the specifications.

### *Tests*

The necessary physical therapy equipment required by the contractor to prove conformance to specifications, shall be furnished by the contractor.

*Approval*

The contractor shall furnish a certificate of approval from the chief engineer of the Department of Water Supply, Gas and Electricity for each item of electrical equipment delivered and installed under these specifications

*Current Supply*

The physical therapy apparatus herein specified must be so designed that it will operate efficiently at 110 to 120 volts, 60 cycles alternating current, unless otherwise specified

*Requirements*

Castings shall be of fine texture with fine lines, sharp, accurate and true profiles of sufficient thickness of metal throughout to withstand the stress imposed on the various parts of the apparatus They shall be free from blow holes, cold shuts or other defects which would impair the apparatus Castings shall have all the necessary ribs, lugs, rabbets, shoulders and brackets Base castings shall be flat on the bottom

Moving Parts Moving parts shall operate smoothly and easily without undue noise and friction Parts required to be counterbalanced shall be coupled to their counterweight with multiple link chain or approved air craft steel cable

Lubrication of moving parts Where moving parts are required to be lubricated, the points of lubrication shall be located at convenient and accessible locations

Safety Devices Whether specifically called for herein or not, all apparatus and equipment shall be designed to minimize the possibility of injury to the operator, patient and attendant

Finish All exposed parts shall be suitably painted, stained, varnished, or lacquered in the bidder's standard color All rails, movable parts, parkerized controls and decorative parts, may be chrome plated or made of stainless steel or smoothed and polished to present a neat appearance and to prevent corrosion All wooden material shall be stained, varnished and otherwise treated to produce a smooth fine finish All non-corrodible alloys shall be free from irregularities and polished to a smooth surface

Except where otherwise indicated, all electrical apparatus shall be housed in a metal or metal lined cabinet, and suitably grounded

Non-combustible materials must be employed throughout for mounting electrical fittings, etc Machine to be provided with automatic over current protection on each leg of circuit Three wire cable to have heavy duty rubber jacket and equipped with a three prong plug, one for grounding, cable should be at least 8 feet long



*Acceptance Test*

Unless otherwise specified, the City reserves the right to test before award at a location mutually agreeable or as called for in schedule, all equipment as to performance and agreement with specifications; similar agreement with regard to the accessory equipment may be enjoyed. These tests may be engaged in before issuance of contract to successful bidder. Certified test data sheets or any part must be furnished when requested.

## SPECIFICATIONS FOR RADIANT HEAT GENERATOR, LARGE SIZE

The Generator shall be complete with 1,000 watt bulb.

The Generator shall be provided with reflecting hood not less than 17 inches in diameter, constructed in a manner to provide adequate ventilation with a maximum temperature rise of all exposed external parts of 80° C. The hood shall be provided with a suitable, wire-mesh protective screen or Pyrex Shield to prevent injury to patient from broken radiant heat bulbs, the screen shall be easily removed for replacement of bulbs.

The reflector shall be so constructed that the rays are practically parallel. It shall be mounted on a suitable, counterbalanced stand with swivel horizontal arm, the vertical range of travel shall be from at least thirty-six (36) inches above the floor to sixty-five (65) inches above the floor, and the horizontal travel shall be not less than ten (10) inches. This stand shall be mounted on a cast iron base provided with at least three ball bearings, swivel, rubber-tired casters not less than 3" in diameter. The size and construction of the base shall be such that there will be no tendency to upset the reflecting hood in any position within the specified range of travel. All points of adjustment shall be self-retaining or provided with suitable locking devices to maintain any desired position within range of adjustment, including rotation of reflecting hood. It shall be possible to place the bulb at least 16 inches from the upright.

The Generator shall have a suitable control switch mounted on the Generator for control of the service current.

## SPECIFICATION FOR GENERATOR FOR RADIANT HEAT, SMALL SIZE

This shall be a lamp having a one piece aluminum, parabolic reflector, not less than 9 inches in diameter, so mounted in an outside hood as to provide an air space between them to secure adequate ventilation with the maximum temperature rise of all exposed, external parts of 80° C. The hood shall be flexibly attached to a telescoping stand having a maximum extension of at least 62 inches and a weighted base not less than 9 inches in diameter. The reflecting surfaces and the location of the bulb are to be so arranged that they will produce practically parallel rays. Stand and reflector to be furnished in a durable manner with at least 8 feet

of rubber covered cord and a durable switch mounted on the lamp. Lamp shall be furnished with a 120 volt, 260 watt carbon filament bulb.

**SPECIFICATION FOR HIGH FREQUENCY (DIATHERMY) GENERATOR, LARGE CABINET TYPE**

The apparatus shall be capable of delivering a smooth, resonant high frequency current, devoid of all faradic and other irritating properties, suitable for therapeutic applications. The apparatus shall be capable of delivering at least 1 ampere with 2 inch auto-condensation pads and at least 2 amperes on short circuit.

This apparatus shall operate on 60 cycle A C 110 or 120 volts, and shall not require more than 12 amperes of current for operation.

The apparatus shall have the following range of service: diathermy, auto-condensation, electrocoagulation, fulguration and desiccation, excitation of vacuum and non vacuum electrodes.

The transformer shall be oil insulated and shall be capable of continuous operation with the temperature rise of any part not exceeding forty (40) degrees Centigrade above room temperature.

The control of the primary current into the transformer shall be the impedance type with not less than five steps, controlled through a variable switch mounted on the control panel and properly identified.

The main oscillating inductances shall be a D Arsonval type and with Oudin resonator, with windings sufficiently heavy to carry the maximum load during continuous operation without breakdown of insulation, it shall be rigidly supported and insulated with suitable material in a manner to reduce high frequency current losses to a minimum.

The spark gap shall have not less than sixteen (16) tungsten points, each point shall be at least one quarter ( $\frac{1}{4}$ ) inch in diameter, the points shall be arranged in pairs with each point in perfect alignment with its mate. The spark gap shall be rigidly supported by insulating material capable of withstanding the high heat generated in the gap during continuous operation, suitable heat dissipating radiators shall be provided for each point and shall be so designed and constructed that heat dissipation will be ample to prevent spark gap points fusing and pitting excessively and insure smooth, uniform sparking between each set of points.

The spark gap shall be provided with means of varying the distance between each pair of points within a useful range and means for cutting in and out any number of points as desired. The control of the spark gap shall be such as to provide fine, even and uniform spacing between each set of points in unison, within a useful range, under all operating conditions, the control should be positive and smooth in operation with no tendency for any part to bind under any operating condition. The spark gap shall be completely protected against accidental contact, all metal parts shall be completely covered with insulating material and a viewing window of heavy plate glass of suitable size shall be provided for observation of

the gap during operation. The manner of protecting the gap shall be such as to provide adequate ventilation and easy access and removal for cleaning and adjustments.

The condensers shall be the Leyden Jar type; no fewer than two (2) shall be provided, or suitable size and type mica condensers immersed in oil; either type shall be designed and constructed for maximum efficiency with the apparatus offered. Each Leyden Jar condenser shall be mounted in a suitable holder made of high grade insulating material and so shaped as to prevent the individual jars from shifting position when apparatus is moved from place to place; each Leyden Jar condenser shall be provided with suitable cover; either type condenser shall be located in relation to other parts of the apparatus in a manner to insure and maintain a resonant patient's circuit under all operating conditions.

Two (2) milliammeters, or one (1) double scale meter, of the thermocouple type shall be provided and mounted on the control panel in a manner to be plainly visible to the operator; one meter shall be scaled from zero (0) to one thousand (1,000) milliamperes and the other meter shall be scaled from zero (0) to three thousand (3,000) milliamperes; if double range meter is provided, it shall have the same scale range; meter scales shall have useful divisions as required in high frequency therapy, with proper numerals; the scales shall be of a length and the numerals and divisions so drawn as to permit easy reading; slight variations in scale range are permissible. A suitable meter changing device shall be provided on the control panel if two separate meters are provided. Each meter shall be provided with zero adjuster. The milliammeter shall be so incorporated in the circuits of the machine, that it may be used to read output for any application except Oudin.

A main control switch for the service current shall be provided; it shall be the quick-breaking type with control handle on the control panel or otherwise conveniently located and arranged with means for the patient to break the circuit.

A footswitch connection shall be provided in the cabinet and so designed and installed as to entirely eliminate all possibility of accidental contact with live terminals or the insertion of treatment cord.

The entire apparatus shall be mounted in a high grade cabinet of suitable size and design, veneered panels being permissible; the cabinet shall be provided with ball-bearing, rubber-tired casters, at least 3" in diameter, and shall have doors for easy access to interior for cleaning and inspection of transformer and other parts; the cabinet shall be constructed and finished in a manner equal to the best practice for high grade furniture. The manner of mounting the apparatus in the cabinet shall be such as to leave no metal of any kind exposed on the outer surface of the control panel, this to include spark, gap control apparatus; the entire apparatus when mounted in the cabinet shall be entirely shockproof, except the Oudin terminal; the patient's terminals shall be recessed and insulated in a manner to prevent accidental contact, except the Oudin terminal, which may be

finished as a metal sphere, all controls, meters and connecting points shall be properly identified

Inside the cabinet door shall be mounted a blue print giving a complete wiring diagram of the apparatus

The apparatus as a whole shall be capable of continuous operation

The apparatus shall be provided with the following accessories

Four (4) high frequency connecting cords, approximately six (6) feet long, with terminal to connect to apparatus on one end and spring clip terminals on other end

One (1) high frequency connecting cord, bifurcated, approximately six (6) feet long, with terminal to attach to apparatus on one end and spring clip connectors on the double ends, the bifurcation to be two (2) feet from ends with spring clip connectors

One (1) high frequency connecting cord, approximately six (6) feet long, with terminal to connect to apparatus on one end and with terminal to connect to fulguration handle on the other end

One (1) high frequency connecting cord, approximately six (6) feet long, with terminal to connect to apparatus on one end and with terminal to connect to auto-condensation handle on the other end

Five pounds diathermy metal

Must conform with general specifications for physical therapy equipment

#### SPECIFICATION FOR HIGH FREQUENCY (DIATHERMY) GENERATOR PORTABLE TYPE

The apparatus shall be for operation on 110-120 volts, 60 cycles, alternating current, and shall require not more than nine amperes for operation

The apparatus described herein shall be designed to deliver a smooth resonant high frequency current absolutely devoid of any faradic or other irritating properties. It must be capable of delivering sufficient current for the proper administration of diathermy

It shall have the following range of service: diathermy, auto-condensation, electrocoagulation (surgical diathermy), fulguration, desiccation, excitation of vacuum and non vacuum electrodes

#### *Transformer*

It shall be capable of delivering a peak voltage of 3,000 volts. The primary and secondary windings shall be insulated from each other, and the secondary windings shall not be grounded in any way. Maximum permissible temperature rise—40° C. after one hour of operation

#### *Current Control*

The regulation of the current into the transformer shall be made through the use of a closed core impedance coil and shall operate through a regulator switch

permitting of five steps of variation. The regulator switch shall be mounted on the inside of the apparatus with no exposed contacts and shall be actuated by a hard rubber knob.

#### *Oscillating Circuits: Inductance*

The main inductance consisting of D'Arsonval windings and the Oudin winding shall be so wound that there is no possibility of slipping or short circuiting between turns, causing a variation in inductance.

The terminals shall be accessible and so marked that the operator may know with which terminals to give diathermy, auto-condensation and electrocoagulation.

An arrangement for delivering the Oudin current shall be provided.

#### *Oscillating Circuits: Condensers*

The condensers used in this machine shall be of the heavy mica and copper plate type. The oscillating circuits shall be equipped with at least two such condensers, assuring constant high frequency characteristics of the current.

#### *Spark Gap*

This apparatus shall be equipped with an extra heavy tungsten gap with a minimum of six points. Tungsten points of not less than  $\frac{1}{4}$  inch in diameter shall be provided on the spark gap. The spark gap shall be equipped with heavy metal radiators and tightly clamped together to permit efficient and rapid cooling of the points in order that the gaps may become quickly deionized after each train of condenser discharges. The gap, itself, shall be built as an independent unit and shall be completely shielded except for ventilation.

#### *Meter*

The meter supplied with this apparatus shall be a milliammeter of the thermocouple type with a scale reading from zero to four thousand milliamperes. It shall be equipped with zero adjustment screw. The milliammeter shall be so incorporated in the circuits of the machine that it may be used to read output for any application except Oudin.

#### *Operating Panel*

The operating panel shall be made of a suitable insulating material and be at least one-quarter of an inch thick. It may be less than one-quarter inch in thickness if reinforced with a sub-panel, in which case the composite thickness of the panel and sub-panel shall be three-eighths of an inch.

#### *Foot Switch*

A foot switch connection shall be provided in the cabinet and so designed and installed as to entirely eliminate all possibility of accidental contact with live terminals, or the insertion of treatment cord.

*Output*

This apparatus shall be capable of delivering at least three thousand eight hundred milliamperes through an impedance equivalent to the chest of an average sized individual with plates measuring one hundred forty four square inches placed anteriorly and posteriorly

*General*

The apparatus shall be provided with an enclosed Mobile Chart equipped with 3" rubber tired ball bearing, swivel casters and fitted with a drawer and shelf for accommodating any accessory equipment

The apparatus shall be provided with the following accessories foot switch, two high frequency connecting cords, approximately six feet long with terminal to connect to apparatus on one end and positive-contact clip terminals on other end, one high frequency connecting cord, approximately six feet long, with terminal to connect to apparatus on one end and with terminal to connect to fulguration handle on the other end, 5 lbs diathermy metal, surgical handle and six needles

Must conform with general specifications for Physical Therapy equipment

## SPECIFICATION FOR ELECTRODE METAL

This metal shall be made in sheets 12 inches wide and .018 inch thick It shall have a center of lead and be coated on each side with pure tin

## SPECIFICATION FOR NON VACUUM SURFACE, ELECTRODE, INSULATED, SMALL

These electrodes shall be made of the best grade of resistance glass carefully annealed The active surface shall be lined within with silver and shall be fitted with a ring terminal They shall be fitted with an unsilvered glass insulated handle

## SPECIFICATION FOR FOOT SWITCH

The switch shall be properly wired, so that when it is stepped upon, it will allow the passage of an electric current from the main service line to a high frequency generator It shall be supplied with Type "S" rubber covered cord No 14, wires at least 8 feet long, with a 2 prong plug to fit receptacle on apparatus for which it is ordered It shall have a current and voltage rating equal to that of the apparatus for which it is ordered

This entire switch shall be shock proof

## SPECIFICATION FOR 2 K V A ROTARY CONVERTER FOR USE WITH HIGH FREQUENCY GENERATOR

Rotary Converter specification, designed for the operation of high frequency apparatus for electromedical use

The converter shall deliver alternating current at 110 volts, 60 cycles, single phase, to operate on 110 volts or 220 volts direct current as specified. The output shall be 2 K.V.A.

The converter shall be rated for constant duty; temperature rise not to exceed 40° C. above room temperature. The converter shall be of ball-bearing construction, dynamically balanced; the commutator to be undercut and hard drawn copper, insulated with high grade mica.

The field frame shall be of steel and the pole pieces of laminated soft annealed steel. The converter shall be of the double wound construction. The A.C. and D.C. ends shall be suitably protected by grid enclosures.

To be supplied with starting box and surge condensers.

#### SPECIFICATION FOR $\frac{3}{4}$ K.V.A. ROTARY CONVERTER FOR USE WITH HIGH FREQUENCY GENERATOR

Rotary Converter specification designed for the operation of high frequency apparatus for electro medical use.

The converter shall deliver alternating current at 110 volts, 60 cycles, single phase, to operate on 110 volts or 220 volts direct current as specified. The output shall be  $\frac{3}{4}$  K.V.A.

The converter shall be rated for constant duty; the temperature rise not to exceed 40° C. above room temperature. The converter shall be of ball-bearing construction, dynamically balanced; the commutator to be undercut and of hard drawn copper insulated with high grade mica.

The field frame shall be of steel and the pole pieces of laminated soft annealed steel. The converter shall be of the double wound construction. The A.C. and D.C. ends shall be suitably protected by grid enclosures.

To be supplied with starting box and surge condensers.

This converter to be of a proper size to fit the carrying table of the high-frequency generator with which it is to be used.

#### SPECIFICATION FOR ULTRA SHORT WAVE GENERATOR 6 TO 7 $\frac{1}{2}$ METERS

This apparatus shall consist of an oscillator, necessary controls and meters, metal cabinet and complete set of accessories.

##### *Oscillator*

This unit shall be capable of generating an oscillating current between 40 and 50 megacycles per second with an output of not less than 175 watts as measured by a phantom in accordance with the method described under *Tests*. The exact frequency selected must be such as not to cause interference with television reception and comply with the regulations of the Federal Communication Commission in force at the time of purchase.

The oscillations of the output circuit shall continue under any condition of

connection or disconnection of external leads, the frequency being constant to within 5%

Under any condition of connection or disconnection of the external leads, the voltage and current limits, given by the manufacturer of any tube used, shall not be exceeded. Such tubes shall be guaranteed for a minimum of 1000 hours or of one year, whichever comes first.

The conductors constituting the output circuit shall at no point in the machine approach closer than 1 cm to any conductor metallically connected or connected through condensers or tubes with the low frequency circuit. This spacing shall rigidly be maintained. In addition, condensers of at least 3000 volts' (peak) rating shall be connected between each patient's terminal and the oscillating circuit. Tuning arrangements shall be sufficiently flexible to permit the following applications: use with pad, 150 square cm to 300 square cm in area at a distance from the subject of from 1 cm to 5 cm, use with a continuous coil, use with orificial electrodes.

All precautions shall be taken to reduce radio interference to a minimum. All electrical parts, except meters, control handles and terminals, shall be enclosed in a grounded metal shield which may be the cabinet. The input power line shall be filtered in such a way that radiation back into the power line is reduced to a minimum.

#### *Controls and Meters*

Means shall be provided either automatically or by suitable manual control to maintain the input voltage to the machine to within 3% of a specified operating value within any variation in line voltage between 105 and 125 volts. Means shall be provided to vary the power output in at least four steps over a range from a minimum of one fourth of specified maximum output, to the specified maximum, the output always being tuned to resonance. The regulation shall be done by means of an auto-transformer or transformer provided with taps varying the ratio of transformation.

Provisions shall be made to protect tubes automatically against operation with plate voltage application without the previous elevation of filament temperatures.

A meter shall be provided to indicate the resonant condition. This meter shall preferably be of the plate milliammeter type. Circuits are to be so arranged that this meter is not overloaded under any condition of connection or disconnection of the external leads.

All switches, plugs, etc., shall be capable of withstanding an overload of 50%.

A pilot light or similar device shall be provided to indicate when machine is operating.

A voltmeter shall be provided to indicate that the filaments are operating at proper voltage. The apparatus shall be provided with a cumulative time indicator,



range 0-10,000 hours. It shall be so connected that it records the total number of operating hours of the equipment.

### *Cabinet*

This apparatus shall be mounted in a cabinet so as to be readily accessible for inspection and repair. The cabinet shall be of sufficiently rugged construction to adequately support the weight of such apparatus and shall be mounted on rubber or rubber-tired, ball-bearing, swivel casters of not less than 3" in diameter. No burns or shocks shall be possible through contact with any exposed part. The cabinet shall have at least one removable panel or hinged door on the inside of which shall be permanently installed a complete diagram of all circuits and connections.

At the option of the City, the following tests may be called for:

### *Tests*

The apparatus shall generate a current of a frequency between 40 and 50 megacycles per second with an output of not less than 175 watts as measured by a phantom constructed and used as follows:

The phantom shall consist of a glass container of the shape of a right rectangular prism, the inside dimensions of the base being  $13.0 \pm 1$  cm. x  $23.0 \pm 2$  cm. Four liters of 0.25% solution of sodium chloride (2.5 grams per liter) placed within this container shall constitute the material to be heated by the short wave current for this test. The minimum output of 175 watts shall be demonstrated through condenser electrodes of area not greater than 200 sq. cm. placed outside the phantom not nearer the solution than 2 cm. at any point. The duration of the test shall be five minutes. Condenser electrodes and leads shall be those supplied with the machine. The power delivery to the phantom shall be calculated from the formula  $P = 56(T - T_0)$  where "P" is the power in watts; "T" average temperature (deg. C.) of the solution immediately after the test, "T<sub>0</sub>" the average temperature of the solution immediately before the test. The temperature shall be measured after thorough stirring of the solution. Conditions are to be so arranged that the temperatures all lie between 20 deg. C. and 40 deg. C. Similar tests made with an orificial electrode suspended in the solution or with a continuous cable wrapped around the container at a minimum spacing of 1 cm. from the solution surface shall demonstrate at least 100 watts in each.

This apparatus shall be so constructed that it will draw not more than 15 amperes from the line at any time during its use and that it can be operated at line voltage of from 110 to 130 inclusive (60 cycles).

The machine shall be capable of a sustained output, without the use of accessory tuning devices, of at least 250 watts. The output shall be measured by means of a photo-electric cell, galvanometer and a 32 volt, 250 watt incandescent bulb equal to General Electric catalogue No. P-25 Locomotive Headlight Bulb,

previously calibrated to record in watts, connection to be made through an air space of at least 2.0 cm. After the operation for 2 hours with 250 watts obtainable power as indicated with the lamp load, the temperature of the core or copper of the transformer shall not be higher than 50 deg C above the temperature of the room.

### *Accessories*

The apparatus shall be provided with the following accessories:

- 1 pair insulated pad electrodes, rectangular, size about 150 sq cm
- 1 pair insulated pad electrodes, rectangular, size about 300 sq cm
- 1 pair rubber insulated pad electrodes, circular, size about 12½ cm in diameter
- 1 pair insulated pad electrodes, circular, size about 15 cm in diameter
- 1 pair electrode cuffs
- 1 induction coil (continuous)
- 1 set of arms or stands for air space electrodes. No hand locking devices shall be necessary.

A suitable space shall be provided in the cabinet for the proper storage of all accessories.

### SPECIFICATION FOR SHORT WAVE GENERATOR

#### 18 TO 25 METERS

The apparatus shall consist of an oscillator, necessary controls, meters or indicators and metal housing and a complete set of accessories. The apparatus shall be mounted on a suitable stand or cabinet with ball bearing, rubber tired swivel casters at least 3 inches in diameter.

### *Oscillator*

This unit shall be capable of generating an oscillating current of a frequency between 12 and 16.6 megacycles per second.

Under any condition of connection or disconnection of the external leads the voltage and current limits given by the manufacturers of any tube shall not be exceeded. Such tubes shall be guaranteed for a minimum of 1000 hours or of one year, whichever comes first.

The main oscillator condensers shall consist of metallic plates using air as dielectric. Condensers of at least 3000 volts (peak) between each patient's terminal and the oscillating circuit shall be provided.

### *Controls, etc*

An intensity regulator of suitable type shall be provided to vary the high frequency output of the apparatus. The regulator knob shall be provided with an indicator and dial permitting duplications of settings.

A suitable means shall be provided for indicating that the circuit is oscillating.

### *Tests*

An output of at least 110 watts shall be obtained using the phantom arrangement as described under the 6 to 7½ meter generator.

### *Accessories*

The apparatus shall be equipped with a flexible cable, 10 to 14 feet long, complete with terminals for attachment to apparatus, also a set of separators and cable insulator.

#### SPECIFICATION FOR ULTRAVIOLET GENERATOR A. C. MOBILE UNIT (High Pressure Quartz Mercury Arc Type)

The ultraviolet generator is to consist of a quartz burner, hood with reflector, supporting stand and control unit.

### *Burner*

The burner is to be of tubular transparent fused quartz with the mercury arc discharge between solid, activated, incandescent electrodes. The arc shall start automatically upon closing of control switch.

### *Hood*

The burner shall be mounted in a suitable hood with inner reflecting surfaces and be provided with doors or shutters so arranged that they will remain fixed in any desired position. The hood shall be provided with ample means of ventilation. The hood shall be so mounted that it turns not less than 90° around an axis parallel to the burner axis.

### *Supporting Stand*

The hood shall be mounted on a horizontal arm of the supporting stand. In addition to the angulations described for the hood, the supporting stand shall provide the following motions of the burner:

Vertical—from a minimum floor distance of not more than 4' 10" to a maximum of not less than 6' 0". Overall height of entire unit not to exceed 6' 10".

It shall be possible to place the burner at least 18 inches from the column of the supporting stand.

The stand shall be mounted on a cast iron base provided with four ball-bearing, swivel, rubber-tired casters not less than 3 inches in diameter.

The stand and arm shall be provided with suitable locking devices or friction joints, so that the horizontal arm and hood will remain in any position in which they are placed.

Base is to be equipped with a suitable handle to wheel the entire apparatus about

### *Control and Meters*

A control unit is to be mounted on the same base as that of the stand. The control unit is to be of all metal construction except where insulation is required. The unit shall include the electrical controls and be provided with an "on and off" switch, a double male receptacle for the line cable. The generator shall be provided with a meter or indicator to indicate when in proper operating condition.

### *Radiation Output*

The burner shall be so designed that the intensity of ultraviolet radiation of wave length of 3130A and shorter shall not be less than 1000 micro watts per square centimeter at a burner distance of 30". The measurements shall be made to include the radiation from the reflectors of the hood.

#### SPECIFICATION FOR A C ULTRAVIOLET GENERATOR, GFILING MODEL

This generator shall be same as mobile type excepting that lamp shall be suspended from ceiling and should be adjustable to similar distances from the floor and shall have a control unit mounted on the wall.

#### SPECIFICATION FOR GAS TUBE QUARTZ ULTRAVIOLET GENERATOR FOR WHOLE BODY AND ORIFICIAL IRRADIATION FOR A C

This generator shall not require more than 3 0 amperes

### *Burners*

This generator shall be provided with

- 1 A transparent fused quartz burner of a spiral type which shall be mounted in a removable head to be used for whole body irradiation
- 2 An orificial burner capable of generating ultraviolet rays within itself, in contact with the tissues, and within a cavity. The emission must be at the end of the generator or applicator, as well as from the side, for its full length

### *Starting*

These burners shall be so constructed that starting manipulation is unnecessary. A switch shall be provided so that upon operating this switch, the burner will light.

### *Cooling*

The cooling shall be by air and devoid of all hose, water and water connections.

### *Efficiency Time*

The generator shall reach its full efficiency in not more than 1½ minutes' time.

### *Burner Life*

The generator must not register a loss of over 5% in one year's continuous operation.

*Transformer*

This generator shall be provided with a transformer which will enable it to operate continuously with a maximum temperature rise of 40° C.

*Base*

This generator shall have a metal base, provided with at least 3 inch ball-bearing rubber-tired, swivel casters.

*Carrying Case*

A carrying case shall be mounted upon a stand and shall be capable of supporting in a rigid position the orificial unit and quartz speculum.

*General*

All metal parts shall be so finished that they will not corrode in any ordinary atmosphere.

This generator shall be able to produce an erythema visible in six hours upon a blonde subject in not more than 45 seconds, the whole-body lamp-head to be not less than five inches from subject.

## SPECIFICATION FOR HIGH FREQUENCY ORIFICAL QUARTZ ULTRAVIOLET GENERATOR

This generator shall be designed to operate from any high frequency machine.

This generator shall consist of a handle and the necessary wiring and attachment mechanism plus a transparent quartz burner.

The handle shall be arranged to accommodate burners of various forms and shall be of suitable insulating material.

There shall be no metal seals or metal electrodes leading into the mercury chambers. The burners shall be arranged to slide into the handle. The exposed part of the burner shall be at least 6" long, tapering from  $\frac{3}{8}$ " to  $\frac{1}{4}$ " in diameter with a slight curvature at the end. The end over a distance of approximately 3" shall be flattened.

The ultra violet generator shall be capable of producing an erythema visible after five hours on a blonde, blue-eyed subject after a compression exposure of 45 seconds.

## SPECIFICATION FOR PROTECTIVE GOGGLES FOR ULTRAVIOLET

These goggles shall consist of two lenses made of glass which is impervious to ultraviolet rays, set in metal frames. These frames shall be set in a piece of pliable leather or cloth so cut that no ultraviolet rays can reach the eyes of a patient. The edges of this fabric shall have a binding stitched on it to prevent fraying, and there shall be an adjustable elastic band attached to the fabric to hold the goggles in place when in use.

## SPECIFICATION FOR LOW VOLTAGE GENERATOR

The apparatus shall consist of a generator, necessary controls and meter, cabinet and complete set of accessories

*Generator*

This unit shall be capable of delivering currents of the wave forms specified below for stimulating muscle and nerve with minimum discomfort to patient. The wave forms available shall be at least the following: Constant direct current, slow surging direct current, and either slow alternating current, or slow surging alternating current.

The patient's circuit shall be adequately insulated from the input power circuits, and from ground to provide maximum safety to the patient.

*Controls and Meter*

The unit shall be provided with a line switch and suitable controls for selecting the wave form and for varying the output current. The latter shall be measured on a DC milliammeter with 0 center and a range of at least 25 m.a. either side of zero. The scale length shall be made so as to provide at least 1 mm deflection per milliampere. There shall also be provided a reversing switch with clear indication of polarity.

The output control shall be so arranged that the output current shall be smoothly adjustable from zero to at least 25 m.a. for any value of output resistance between 0 and 3000 ohms.

*Cabinet*

The apparatus shall be built into a suitable cabinet and so arranged as to be readily accessible. The cabinet shall be equipped with rubber tured ball bearing swivel casters of at least 3 inches in diameter. Complete wiring diagram of apparatus shall be mounted on removable panel of cabinet.

*Tests*

At the option of the City, the following tests may be called for.

The unit shall draw not more than two amperes at 120 V and shall be capable of operation from 110 to 130 volts (60 cycles).

Constant direct current. A uniform current containing no 'ripple' in excess of 3%. This "ripple" shall be determined as follows. The output terminal shall be connected through a resistance of R ohms. Across the terminals there shall also be connected an AC voltmeter of at least 2000 ohms resistance in series with a condenser of at least 10 microfarads. If the reading of the milliammeter

is denoted by  $i$  (milliamperes) and the reading of the voltmeter by  $v$  (volts), the per cent ripple shall be defined for this purpose as equal to  $\frac{v}{i \times R} \times 100,000$ .

Determinations shall be made under the following conditions:

- |              |               |
|--------------|---------------|
| 1) $R = 100$ | 2) $R = 2000$ |
| $i = 25$     | $i = 25$      |

**Slow surging direct current:** A pulsating direct current, with a slow building up for each pulsation, and a slow decay. The frequency of pulsations shall be within 40% to 60% of the length of a period. The ripple requirements for this current shall be the same as for the constant direct current, using maximum values for  $i$  and  $v$ , and shall be determined at about 20 periods a minute. The speed of building up and decay of the pulsations shall be estimated as follows: The same basic circuit as for the "ripple" determination is used, except that an oscillograph is to be substituted in place of the voltmeter and condenser. The resistance of the oscillograph circuit shall be above 5000 ohms. The voltage as determined by the oscillograph circuit shall attain for each pulsation within 10% of its final value in not less than  $\frac{1}{4}$  second. The decay shall be approximately symmetrical with the building up. The oscillograph must be operated with infinite time constant. The voltage during the "off" periods shall not exceed 20% of that during the "on" periods.

**Slow alternating current:** An alternating current of frequency in the range of at least from 10 to 40 cycles per minute. The high frequency "ripple" shall be subject to the same requirements, determined in the same way, as for the constant direct current. The wave-form is to be such that each half-cycle is an approximate mirror image of the preceding half cycle as determined by the oscillograph used as indicated under slow surging direct current. The wave front of each half-cycle shall be subject to the same requirements as to the pulsations in the slow surging direct current. The voltage in succeeding half cycles shall be identical to within 10%.

**Slow surging alternating current:** An alternating current of frequency 60 cycles per second modulated by a wave form corresponding to either the slow surging direct current or the slow alternating current. The building up and decay shall be determined by the oscillograph from the envelope curve. When the current is used the milliammeter shall show no deflection (although remaining in the circuit).

There shall be no time delay beyond 15 seconds between connecting this apparatus and its proper operation.

#### *Accessories*

As part of the generator, a complete set of accessories shall be provided as follows:

- 1 pair treatment pads about 3" x 3"
- 1 pair treatment pads about 4" x 5"
- 1 pair treatment pads about 6" x 8"
- 1 diagnostic handle, equipped with a foot switch connected in series with it

#### SPECIFICATIONS FOR BATTERY OPERATED GALVANIC GENERATOR

This apparatus shall consist of a carrying case with handle and containing a 45 volt "Heavy Duty" battery (equal to Burgess No 21308) connected through a switch to an adjustable voltage-divider. The output side of voltage divider shall be connected through a milliamperemeter (scale 0-50) to patient terminal, marked for polarity. The voltage divider shall have a resistance of 500 to 1000 ohms. Provision shall be made for easy replacement of batteries.

Two cords suitably identified and each 4 feet long shall be furnished.

#### SPECIFICATION FOR FARADIC STIMULATION

This Generator shall be able to produce a current similar to that of the Bristow Faradic Coil. It shall be mounted in a carrying case with a handle. This Generator shall be supplied with necessary dry cells, two treatment cords, one indifferent electrode and one diagnostic electrode with interrupter handle, or other apparatus producing similar currents.

#### SPECIFICATION FOR INTERVAL TIMER

This timer shall consist of a clock with an indicator which may be accurately set to cause an alarm to ring at any desired number of minutes from one half to sixty. Variation of not more than 5% is allowed when tested by a stop watch.

This clock shall run at least thirty hours upon one complete winding.

#### SPECIFICATION FOR MESSAGE OR TREATMENT TABLE (wood)

##### *Type*

Table shall be of the rectangular flat top design.

##### *Size*

Over all length 74 inches

Over all width 26 inches

Over all height, including 2" thick cushion, 33 inches

##### *Material*

Table shall be constructed entirely of wood and carry a slatted wood undershelf. Wood shall be of solid beech or birch, thoroughly seasoned and kiln dried, with all exposed surfaces smoothly dressed.



*Top*

Top shall be level, 74" long  $\times$  26" wide  $\times$  at least  $\frac{7}{8}$ " thick and carry on its longitudinal edges a raised square edge moulding or strip 1" wide  $\times$   $\frac{3}{4}$ " high securely attached with countersunk screws, to retain the top cushion in position.

*Legs*

Legs shall be of solid stock  $2\frac{1}{2}$ " square  $\times$  30" high, located beneath the four corners of the top to which they shall be securely attached with countersunk screws.

Securely mortised into and centrally located between the top of these legs, there shall be an apron 5" high  $\times$   $\frac{7}{8}$ " thick also securely attached to the top by means of countersunk screws.

The legs shall be braced at both ends of the table by a wood stretcher set on edge,  $2\frac{1}{2}$ " wide  $\times$   $\frac{7}{8}$ " thick, centrally mortised into the legs and carrying a slatted longitudinal undershelf which shall finish approximately 13 inches above the floor.

*Shelf*

Shelf shall consist of three (3) longitudinal slats centrally located on the top of the stretchers and secured to same by countersunk screws. Each slat shall measure 3" wide  $\times$   $\frac{7}{8}$ " thick  $\times$  74" long with rounded top edges and spaced  $1\frac{1}{2}$ " apart.

*Finish*

All exposed surfaces of wood shall be finished in walnut and varnished or as called for in the invitation to bid.

*Cushion*

Cushion for top shall be 24" wide  $\times$  74" long and carry a one-piece 2" thick sponge rubber pad encased in a one-piece, single-coated maroon, rubberized sheeting. This casing and also the pad which slips into it shall be removable and reversible and shall be constructed with a square or box edge. The completed cushion shall fit neatly between the longitudinal edging of the table top.

## TEMPERATURE CONVERSION

( $^{\circ}\text{F}$  to  $^{\circ}\text{C}$ )

$^{\circ}\text{F}$	$^{\circ}\text{C}$	$^{\circ}\text{F}$	$^{\circ}\text{C}$	$^{\circ}\text{F}$	$^{\circ}\text{C}$	$^{\circ}\text{F}$	$^{\circ}\text{C}$
31	-0.6	61	16.1	91	32.8	121	49.4
32	0.0	62	16.7	92	33.3	122	50.0
33	0.6	63	17.2	93	33.9	123	50.6
34	1.1	64	17.8	94	34.4	124	51.1
35	1.7	65	18.3	95	35.0	125	51.7
36	2.2	66	18.9	96	35.6	126	52.2
37	2.8	67	19.4	97	36.1	127	52.8
38	3.3	68	20.0	98	36.7	128	53.3
39	3.9	69	20.6	99	37.2	129	53.9
40	4.4	70	21.1	100	37.8	130	54.4
41	5.0	71	21.7	101	38.3	131	55.0
42	5.6	72	22.2	102	38.9	132	55.6
43	6.1	73	22.8	103	39.4	133	56.1
44	6.7	74	23.3	104	40.0	134	56.7
45	7.2	75	23.9	105	40.6	135	57.2
46	7.8	76	24.4	106	41.1	136	57.8
47	8.3	77	25.0	107	41.7	137	58.3
48	8.9	78	25.6	108	42.2	138	58.9
49	9.4	79	26.1	109	42.8	139	59.4
50	10.0	80	26.7	110	43.3	140	60.0
51	10.6	81	27.2	111	43.9	141	60.6
52	11.1	82	27.8	112	44.4	142	61.1
53	11.7	83	28.3	113	45.0	143	61.7
54	12.2	84	28.9	114	45.6	144	62.2
55	12.8	85	29.4	115	46.1	145	62.8
56	13.3	86	30.0	116	46.7	146	63.3
57	13.9	87	30.6	117	47.2	147	63.9
58	14.4	88	31.1	118	47.8	148	64.4
59	15.0	89	31.7	119	48.3	149	65.0
60	15.6	90	32.2	120	48.9	150	65.6



# INDEX

- Abdomen, cold applications to effect of  
on peristalsis, 12, on stomach, 11 on  
visceral pain, 11, on visceral tempera-  
ture, 7-8  
cold heating compresses on, effect of, 53  
distention of, in fever therapy, 192  
effect of, on good posture 362  
hot abdominal pack on effect of, 56  
turpentine stupes for 57-60
- Abdominal adhesions 546
- Abdominal breathing exercises, for asthma,  
602-3  
supine posture for, 354-6
- Abdominal exercises, for hernia 372-3  
for posture 346, 362, 364
- Abdominal massage, 329  
contraindicated 330
- Abdominal packs 56
- Abdominal rigidity and tenderness, effect  
of ultraviolet rays on 546
- Abdominal weakness, effect of, on posture,  
362  
sinusoidal and surging faradic currents  
for, 545
- Ablutions, *see* Baths, ablutions
- Abortion, septic ultraviolet irradiation in,  
315
- Abramson, H., 238, 601
- Abscess, circumscribed, short wave con-  
traindicated, 170  
ischio-rectal electro-surgery for, 217  
of central nervous system electro-surgery  
for, 217  
of lung diathermy for, 599 ultraviolet  
radiation for 311  
prostatic, thermo-therapy for, 553
- Abscesses multiple, 443
- Absorption of light rays by deeper tissues  
98, 288  
by eye media 575  
by skin, 97, from tungsten arcs, 20
- Accidents, during treatment, 435 burns,  
41, 112, 114, 163, 192, 225 437-8,  
440-2 electric shock, 437 443, eye  
injuries, 305 from explosion of an  
esthetics 439, from radiation 437,  
from therapeutic lamps 438 responsi-  
bility for, 430  
from household appliances, 444
- Acetylbetamethyl choline chloride ionto-  
phoresis, 237  
asbestos paper pads for, 233, 532  
indications for, 237, 452, 532-3, 566 610  
solution for, 532  
systemic effects of, 231  
vasodilating effect of 532
- Achilles tendon, stretching exercises for,  
368
- Achyilia gastrica, spa therapy for, 539
- Acid base balance, effect, of high altitude  
on, 70-1, of temperature rise on, 16  
in fever therapy, 181  
massage with, 321
- Acne rosacea, cutting current for, 611  
electrodesiccation for, 611  
galvanic surgery for, 240
- Acne vulgaris, Cutler's solution for 613  
freezing for, 26  
ultraviolet and x rays for 613  
zinc ions for, 238
- Aconite by iontophoresis for trigeminal  
neuralgia, 237 504-5
- Acrocyanosis carbon dioxide baths for, 523
- Actinomyces four meter short wave for,  
150
- Adam's position for diagnosis of scoliosis,  
353
- Addison's disease, climate for, 73  
ultraviolet radiation contraindicated 316
- Adenoid tissue, electro-surgery for 587
- Adenoma sebaceum, 610
- Adhesions, abdominal, diathermy for, 546

- Adhesions—(*Continued*)  
 chronic, oven bath for, 21  
 massage for, 324  
 pleural, altitude for, 75; electrosurgery for, 216  
 prevention of, by faradic current, 261  
 short wave for, 546  
 static wave for, 270  
 surging contractile current for, 546  
 tendonous, treatment, 474
- Adhesive strapping, for Bell's palsy, 503  
 for low back pain, 470  
 for sprained ankle, 465
- Adipose tissue, *see* Fat
- Adrenalin, by iontophoresis, 236  
 effect of, on thermal sensibility, 433
- Affusions, *see* Baths, affusions
- Aged, the, artificial hot water baths contra-indicated, 30  
 cold baths contra-indicated, 34
- Air, circulation of, in fever cabinets, 177;  
 to prevent dehydration, 186  
 cold, analgesic effects of, 26  
 critical temperature of, 10  
 effect, of drafts of, 6; on blood flow, 6, 26; on blood potassium, 70; on blood pressure, 69; on bodily vigor, 69; on disease incidence, 69; on metabolism, 69; on nasal mucous membrane, 67; on skin capillaries, 67  
*See also* Baths, cold air  
 components of, 67  
 compressed or rarefied, treatment by, 73-4  
 cooling by, in cabinets, 21, 495  
 following fever therapy, 188-9  
 for peripheral vascular disease, 525  
 with refrigeration, 22  
 to retard gangrene, 526  
 heated, 19-20  
 dry, 19-20; contra-indications for, 19; indications for, 20, 525-6; temperature, 20, 526  
 humid contra-indications for, 21; duration of, 21; humidity of, 20; indications for, 21, 177-8; temperature, 21  
 local effects, 13, 16-7  
 systemic effects, 16, 18; *see also* Fever therapy  
 treatment by, in cabinets, duration of,
- Air—(*Continued*)  
 heated—(*Continued*)  
 20-1; for elimination, 21; heating mechanism, 20-1; humidity, 20-1, 177-8; indications for, 20; technique for, 20-1; temperature of, 20-1; types of, 20-1, 177-8  
 humidity of, 67  
 ionized, 77  
 motion of, a component of climate, 67  
 reaction to, 2, 11  
 sterilization of, by ultraviolet radiation, 297-8  
 temperature of, artificial control of, 75-6, 102-3, 495  
 critical, for metabolic rise, 4, 10, 14  
 effects of, 15, 66, 68  
 for refrigeration therapy, 22  
 in cabinet baths, 20  
 in cooling boxes, 22  
 in heating hoods, 21, 525-6  
 in Russian baths, 21  
 in Turkish baths, 19  
 physical factors controlling, 67-8  
 toleration limits, 4, 10-2, 15  
 warm, for peripheral vascular disease, 525
- Air-conditioning, artificial, humidity with, 75-6, methods of, 68, 75-6; pneumatic chambers for, 76; temperature control in, 102-3  
 disadvantages of, 75-6  
 indications for, 76  
 natural, by change of climate, 72, by upper respiratory tract, 69  
 with refrigeration therapy, 22
- Air pressure, alternating, 529  
 barometric, *see* Atmosphere  
 for vascular disease, 530-1
- Aix douche, 64
- Albinos, pigmentation of, 294
- Albuminuria, alkaline mineral water for, 82
- Alcoholism, chronic, electric cabinet contra-indicated, 515  
 Scotch douche for, 64  
 sulfur alkaline mineral water for, 86
- Alkalosis, from dehydration, 185
- Allen, C. E., 480-2, 537
- Allergy, air-conditioning as preventive, 76, 691

- Allergy—(Continued)  
 desensitization by cold water, 17  
 epinephrine ions, treatment by, 238  
 tests for, by iontophoresis, 238  
*See also* Photo-allergy
- Alopecia areata, iontophoresis for, 238  
 photodynamic therapy for, 297  
 ultraviolet radiation for, 615
- Alpine sunshine, 275
- Alternating currents, 220  
 commercial 221, rectification of, 221, 223  
 faradic, 260-2, surging 261  
 high frequency, 109 111  
 sinusoidal, 262  
 static, induced, 270  
 surging, 263  
 uses of, 269-70
- Altitude, high, and solar energy, 281, blood changes in, 70-1, for pulmonary tuberculosis, 596 for sympatheticotonic individuals 596 for vagotonic individuals, 596, heliotherapy in, 75 humidity at, 67-8, indications for 74-5 oxygen at, 70 pressure at, 70, symptoms caused by, 70, 73 temperature at, 70 rapid change of, symptoms caused by, 70 tuberculosis and, 596
- Altro Work Shops, New York City, 429
- Alum photosensitivity nullified by, 294
- Ambulation, 419-20  
 in paraplegia, 415-7
- Amenorrhoea, treatment for, 572
- American spas, 86-9
- Ampere, 220
- Amputation stump, preparation of, 418-9
- Amputations 417-20  
 double arm, 418  
 double leg, 418  
 Kessler kineplastic arm, 418  
 massage for, 329, 482  
 postoperative treatment, 482-3  
 prosthesis for, 418  
 refrigeration anesthesia for 480-2  
 scoliosis in, danger of 420  
 unilateral exercises for, 419  
 whirlpool baths after 45 329 483
- Amputations bilateral, exercises for, 419
- Amytal, with fever therapy, 184
- Analgesia, by galvanic current, 222  
 by phototherapy, 104-5
- Analgesia—(Continued)  
 by short wave current, 164  
 cold for, 22, 25-6
- Anderson, W T, Jr, 97
- Anelectrotonus effect, 224
- Anemia, pernicious, climate for, 73  
 secondary, massage for, 329 spa treatment for, 85, ultraviolet radiation for, 290, 312
- Anesthesia, choice of, for electrosurgery, 203  
 general, danger with electrosurgery, 209  
 local by chilling 26, 433, 461, 480-3, by drugs, 209, 461, in electrosurgery, 209, 582, thermal sensitivity affected, 433
- Anesthesia, in paraplegia, 413-4
- Aneurysm aortic, carbon dioxide baths contraindicated, 523
- Angina pectoris, and carbon dioxide baths, 523  
 and diathermy, 134-5  
 arm and hand baths for, 41, 44  
 bed rest in, 374  
 conductive heating for, 524  
 massage for, 329  
 short wave technique for, 525, precautions, 525
- Angioma, destruction of, by radium, 609  
 electrosurgery for, 238, 609
- Angstrom unit, 92
- Animals treated by spa therapy, 78
- Anions in mineral waters, 79
- Ankle joint, exercises for, 341  
 sprained, treatment of, 327, 465
- Ankylosis, prevention of, 328
- Anode, bubble test for, 222  
 cations migration to, 232  
 chemical reactions at 222  
 dehydrating effect at, 222  
 for iontophoresis of anions 231  
 hydrogen ions migration from, 231  
 litmus test for, 223  
 physiological effects at, 224 231  
 positive pole of galvanic current 222
- Anorexia, *see* Vomiting
- Anosmia, hysterical, 512
- Anoxemia, from altitude, 70  
 from fever therapy, 180, 182
- Antepartum irradiation, 309-10
- Anthracene, 297
- Anthraquinone, 296-7

- Anxiety, neutral baths for, 30
- Aphasia, coordination and, 420  
 exercise in, 420  
 rhythm, use of, 421  
 types of, 420
- Aphasics, training for, 421
- Aphonia, hysterical, 512
- Apical infection, test for, 536-7
- Apnea during fever therapy, 182
- Apparatus, 617 ff.  
 care of, 435-6  
 specifications for, 435, 617 ff.
- Appetite, loss of, from bed rest, 373
- Arano kineplastic arm, 418
- Arc, carbon, *see* Carbon arc lamps  
 electric, 282  
 iron, 282  
 mercury, *see* Mercury arc lamps  
 tungsten, *see* Tungsten filament lamps
- Arcing, a cause of burns, 114, 437
- Arrhythmias, cardiac, cold compress for, 53; ice bag for, 524  
 functional, carbon dioxide baths for, 523; cold compress for, 53
- Arrowhead Hot Springs, 87
- Arsenicals, as photosensitizers, 296
- Arterioles, injuries to, from cold, 10
- Arteriosclerosis, and cold douche, 63  
 and massage, 330  
 and Russian baths, 21  
 and saline baths, 38  
 and Turkish baths, 19-20
- Arthritis, ablutions for, 46  
 acute, and diathermy, 136, and massage, 328; ice bags for, 446  
 atrophic, 453  
 psychic factors in, 456  
 symptoms of, 446  
 treatment of, baths, 42, 446, 454; colonic irrigation, 455; diathermy, 447-50, 451, 452; exercise, 453-4; faradic current, 453; fever therapy, 196, 454-5, galvanic current, 450, 453, heat, 41, 446-51, 455; histamine ions, 452; immobilization, 453; iontophoresis, 452; massage, 455; mobilization, 453-4, of acute stage, 446, 453; radiant heat, 105; spa therapy, 455-6; swimming, 453; symptomatic, 445-6; to alter systemic back-
- Arthritis—(*Continued*)  
 treatment of—(*Continued*)  
 ground, 445; underwater exercise, 454  
 baths for, 20, 21, 33, 35, 38, 42, 446  
 brucellar, 168-9, 196  
 cervical, 454  
 chronic, 35, 328  
 hot water baths for, 34, mud baths for, 447; static wave for, 271  
 cold for, 46  
 diathermy for, 168  
 etiology of, 445  
 exercises for, 33, 395, 453  
 faradic current for, 261  
 gonococcal, exercise for, 457; fever therapy for, 454, 534; heating for, 169, 457, 551-6; massage for, 455; sulphonamides for, 551  
 gouty, 457  
 heliotherapy for, 280  
 iodine ions for, 237  
 iontophoresis for, 237, 452  
 irradiated blood, reinjection of, 316  
 lithium ions for, 237  
 massage and, 328  
 medicinal ions for, 237  
 menopausal, 457  
 occupational therapy for, 446  
 osteo-, 456  
 paraffin baths for, 23  
 phototherapy for, 105  
 postural training for, 454  
 radiant heat baths for, 20, 446  
 rheumatoid, ultraviolet in, 315  
 salicylic ions for, 237  
 Scotch douche for, 64  
 spinal, 155  
 syphilitic, fever therapy for, 457  
 traumatic, 457  
 treatment, principles of, 453-4  
 types of, 196, 328, 445, 456-7  
 ultraviolet radiation for, 308, 455  
 wet packs for, 48
- Arthrometer, 381
- Artificial eye, 422-3
- Artificial fever, as therapeutic measure, 173-4  
 bactericidal effect of, 457  
 control of, 174

- Artificial fever—(Continued)**  
 death from, 182  
 methods of inducing, compared, 174, 179-488, diathermy, 176, electric light bulbs, 177 hot water baths, 15, 33, 173, 174, 175, 454, hot drinks 174 humid ity, 177-8, infrared heating units, 177, inoculation, 174 sleeping bags, 176, short wave diathermy, 457 treat ment cabinets, 177-8  
 pathological changes with 182, 191  
 physiological changes during, in blood, 180-2 187, in gastric secretion, 182 in heart action 180 in respiration, 181, 192 in skin, 179 185 in water loss 180-1 in weight, 180  
*See also* Fever therapy
- Artificial respiration apparatus for** 604  
 carbon dioxide and oxygen with, 605  
 indications for, 604  
 methods, 604
- Asbestos paper for iontophoresis**, 233-4
- Asthenic states, continuous baths contra** indicated 32  
 towel rub for 47
- Asthma, blowing exercise for**, 602  
 breathing exercises for, 601-4  
 bronchial, abdominal breathing exercises for, 601-3 air-conditioning for, 75 601 climate for, 72 600 epinephrine ions for, 601 exercises for, 601-4 fever treatment for, 195, 601, inhalations for 77, 601-4, ionized air for, 77 short wave current for, 169 spa therapy for 600-1  
 ultraviolet in 315
- Atmosphere climate and**, 67  
 components of and health, 67-8  
 humidity of 67-8  
 ions in, 71-2 77  
 solar rays limited by 275  
 temperature of 67  
 ultraviolet radiation modified by, 275
- Atmospheric pressure**, 70  
 artificially controlled alternating nega tive positive 529-30, for inhalation therapy 76, for pneumatic chambers, 76
- Atrophy conceptions of** 491  
 muscular, faradic and galvanic stimula tion for, 264-5, from disuse, 491, from nerve injury, 491, massage for, 322, passive movement for, 334 whirlpool bath for, 43
- Attitude, mental, in blindness**, 423
- Audiometer, in aural disability**, 423
- Audo-Gianotti G B**, 596
- Aural disability**, 423
- Autocondensation, indications for**, 132, 135, 476  
 technique, direct 132-3 indirect, 476  
 thermal effects of, 132-3
- Automatic time switch**, 300
- Automatic timer for treatments**, 167, 300, 435
- Autonomic system**, 16
- Bachem A**, 96
- Back low pain, novocaine iontophoresis** for, 237
- Backache** *see* Low back pain
- Bacterial endocarditis, fever therapy for**, 524  
 temperature response to invasion of, 4
- Bactericidal action of artificial fever** 457  
 of fluorescent drugs, 298  
 of irradiated lipids, 300  
 of mercury vapor lamp 284  
 of various wave lengths 289
- Bags, for conductive cold**, 26  
 for conductive heat air, 25 by circulat ing water 25 chemically heated, 25, hot salt, 25, hot sand 25 hot water, 25 170, 562  
 sand 121, 434  
 sleeping, 176
- Balkan frame in exercise for paraplegia**, 415
- Bandage, for amputation stump**, 419
- Banyai P L**, 311, 596
- Barbiturates as photosensitizers**, 296  
 dangers from, 185
- Barker, N W** 532-3
- Barnacle C H** 515
- Barometric pressure, see** Atmospheric pres sure
- Baruch S** 30, 45 61
- Bastedo technique for colonic irrigation** 543-4



- Baths, ablutions, described, 46; indications for, 46; technique, 46; temperature of, 46
- affusions, described, 46; indications for, 46; materials for, 46; technique, 46; temperature of, 46
- arm and hand, described, 41; indications for, 41, 44; materials for, 41; technique, 41; temperature of, 41-2
- bland, described, 38, 608; indications for, 38, 608
- blanket, *see* Packs
- brine, artificial, 38; at spas, 78; buoyancy of, 38; effects of, 80-2; indications for, 38, 84, ocean, 73
- carbon dioxide, artificial, 35-8; contraindications for, 38, 492; douches with, 523; effects of, 3, 37, 81, 523, 532-3; exercise with, 523; frequency of, 523; indications for, 38, 85, 523, 532, massage with, 523; natural, 88; partial, 523; precautions with, 523; temperature of, 35-6, 80, 524, types of, 523
- classified, 456
- cold, contraindications for, 34; duration, 34; effect of, 15; indications for, 34; massage following, 33; reaction to, 30, 34; temperature of, 29
- cold air, contraindications for, 69; effects of, 2, 3, 11-3, 14-5, 21-2, 26, 29; hypersensitivity to, 16; precautions for, 26
- continuous, contraindications for, 31-2; duration, 31; indications for, 32, 515, 608; inunctions for, 32, technique, 31-2
- contrast, duration, 41; indications for, 42; materials for, 41; technique, 41, 446; temperature, 41-2
- cool, 34
- dosage, 29
- drip sheet, 46-7
- foam, 39
- foot, 438; hot, for sprains, 465
- galvanic, 226-7, 269-70, indications for, 452
- half, 39, 45, 523
- hot air, *see* Air, dry; Air, humid
- hot water, contraindications for, 30, 34; duration, 33; effects, 30, 34, 174, 524; heat loss in, 33; indications for, 15, 33-4, 175, 424; massage with, 34; materials, 33-4; preliminary to cold bath, 30; technique, 33-4; temperature, 29, 30, 33-4; thermal springs, 86-9, 173
- immersion, 31; and cardiac cases, 31
- increasing temperature, 524
- leg and foot, cold, 41; duration, 41; hot, 41; indications for, 41; technique, 41; temperature, 41; with mustard, 41
- medicinal, artificial, 35-7, 81, 608; "cure crisis" with, 81; natural, 79, 80
- mud, contraindications for, 23, "cure crisis" with, 81; duration, 23, 447; indications for, 23, 447; mechanical pressure of, 23; reaction to, 23, 81; specific heat of, 23; technique, 23, temperature of, 23, 447
- neutral, 31
- oxygen, 38
- paraffin, 22-4
- peat, *see* Baths, mud
- radiant heat, cabinets for, 104; contraindications for, 515; duration, 20-1; effects of, 100, 515; electric bulbs for, 20, 104, 177; in cabinets, 20, 104, 177-8; in hoods, 102-3; indications for, 20, 104-6, 446, 459, 614; pigmentation from, 99; preliminary to Scotch douche, 104; radiant intensity in, 101; technique, 99-104; temperature in, 19
- Russian, *see* Air, heated
- seawater, *see* Baths, brine
- sheet, 46
- shower, 61
- sitz, 45, indications for, 553, 560
- sponge, 39-40
- static, *see* Static bath
- steam, 84
- sun, injuries from, 277, 279
- sweat, 173
- tepid, 45, 513
- Turkish, *see* Air, heated
- vapor, 20-1, 83
- whirlpool, 43-5, 526, 533
- zinc ions for, 238
- Battery, electric, for galvanic current, 223, 233
- for iontophoresis, 232-3
- portable, 233
- Baudish, O, 81

- Bazett, H C, 11, 16, 179-80  
 Bazin's disease, electrosurgery for, 613  
 Beard, H H, 296  
 Beck, J C, 565  
 Bed, exercises in, 528  
   rocking, 528  
   special, for lower back conditions, 471,  
   473, for peripheral vascular disease,  
   528  
 Bed rest, chair rest as alternative for,  
 373-4  
   dangers from, 373-4  
   pathology resulting from, 373-4  
 Bee venom by iontophoresis, 452  
 Beer, E, 217  
 Bellevue Hospital, occupational therapy at,  
 387  
 Bell's palsy, causes, 502-3  
   complications, 503-4  
   treatment, by active exercise, 504, by  
   adhesive strapping, 503 by electric  
   exercise 503, by massage, 324 by pho-  
   tothermy, 106 503, by saline iontopho-  
   resis 237, by sodium ions, 237, by  
   splints, 503, by static brush discharge,  
   106, 273, 503  
 Belt, electrode, 118  
   supporting 470  
 Benzoflavin photosensitization by, 296  
 Berger loupe, 240 242  
 Bernhard, O, 275, 280  
 Best, C H 331  
 Bicycles in occupational therapy, 395, 397  
 Bier, E, 21, 530  
 Bierman W 119-21, 207, 564-6 589  
 Biliary tract mineral waters for, 83  
   short wave for, 540  
 Binger C A L., 124 128  
 Binni L., 513-4  
 Binocular vision, re-education for, 421-2  
 Birch Hirschfeld lamp, 576  
 Bisgard J D 8  
 Biterminal electrodes 208-9 307  
 Biterminal technique for electrocoagula-  
 tion, 207  
 Bladder atonicity, electric currents for,  
 556 in paraplegia 414 sitz baths for,  
 45  
   growths electrosurgery for, 216, 528  
 Blankets electric, 25  
   for shock, 25  
 Blankets—(Continued)  
   to produce fever, 175  
 Bleeding, controlled by electrosurgery, 218  
   diathermy contraindicated, 136  
 Blepharitis, physical therapy for, 546  
   ultraviolet radiation for, 312  
   x ray for, 546  
 Blind, sheltered workdrops for, 429  
 Blindness, 422-3  
   dark glasses contraindicated, 423  
   hysterical, short wave for, 512  
   occupational therapy for, 402  
   mental attitude in, 423  
   personal hygiene in, 422  
   vocational counselling in, 423  
 Block printing in occupational therapy,  
 389-91  
 Blondes, and pigmentation 294  
   sensitivity to ultraviolet radiation, 289  
 Blood, changes in, from conductive cold  
 15, from conductive heat 15, 17, from  
 fever therapy, 180-2 from high alti-  
 tude 69-71, from massage, 321 from  
 radiant heat, 98-9, from ultraviolet  
 radiation, 289-90  
   coagulation in electrosurgery, 216  
   flow of, in active muscles, 332  
   irradiation direct by ultraviolet radia-  
   tion with Kromayer lamp, 315-6  
   oxygen capacity of, from massage 321  
   photosensitization of, 295, 297  
   velocity, determined by fluorescence, 295  
   effect, of artificial fever on, 182, of  
   cold on, 13, of exercise on, 332, of  
   heat on, 123, of massage on, 321-2  
   venous 11  
   viscosity, effect of fever therapy on, 180  
   volume effect of climate on, 68 of cold  
   on 11-3, 26, 30, 68, of contrast baths  
   on, 446 of heat on, 11-3, 68, 98-9 of  
   irritants on, 15-6 of ultraviolet radia-  
   tion on, 290  
   water content of, effect, of altitude and  
   air pressure on, 69, of fever therapy  
   on, 180  
 Blood plasma, use of, in fever therapy  
 shock 104  
 Blood pressure cold weather and, 69  
   from active exercise, 332  
   in capillary loops, 13-4  
   in shock, 269

- Blood pressure—(*Continued*)  
 systemic reflex, from carbon dioxide baths, 36; from cold air, 13-4, 26; from conductive cold, 13; from conductive heat, 32, 37; from fever therapy, 180; from heat radiation, 98; from high altitude, 71, from seasonal changes, 69; from ultraviolet radiation, 106, 290
- Blood reservoirs, balancing of, 13  
 skin capillaries as, 1
- Blood vessels of skin, 1  
 cold and heat, effect on, 16-7; reflex dilation of, 11  
 compression, effect on, 499  
 tonus of, 10  
 ultraviolet radiation, local effects on, 289
- Body, activities of, and climate, 68  
 distribution of electrical currents in, 141-2  
 electrical conductivity of, 141  
 heat production, 19  
 infrared radiation emitted, 91  
 posture, 341 ff.  
 temperature of, 2, 4, 11; mechanism for maintaining, 2  
 training of, 336 ff.
- Boils, electrosurgery for, 612  
 short wave current for, 169-70  
 zinc ions for, 238
- Bolman's gentian, 570
- Bone, atrophy from bed rest, 373  
 calcium of, and vitamin D, 290  
 dielectric constant of, 141  
 heating of, by short wave, 141  
 tuberculosis of, and ultraviolet radiation, 280
- Bony fusion, massage contraindicated, 330
- Boots for positive-negative air pressure, 529-30
- Bottle, hot water, 19, 48
- Bourgignon, G., 486-7
- Boyd, D., 452
- Braces, in paraplegia, 414
- Brachial neuritis, cabinet baths for, 20  
 causes, 506  
 heat for, 23, 506  
 manipulation for, 506-8  
 mud baths for, 23  
 traction-suspension for, 506-8
- Bradford, S. S., 453
- Braille, 423
- Brain, congestion of, mustard leg and foot baths for, 41  
 lesions, 485, 488  
 temperature of, from diathermy, 487; from ice bags, 8-9
- Brandeleone, H., 374
- Breast tumors, electrosurgery for, 217, 219
- Breathing, abdominal, 354-6  
 altitude and, 70, 74  
 apnea, 181  
 Cheyne-Stokes, 71  
 coastal, 354-6  
 dyspnea, 70, 192, 597  
 exercises, 344, 345, 354-6, 362, 501, 601-2  
 rhythm, 354  
 volume of, and barometric pressure, 70
- Brine baths, *see* Baths, brine
- Bronchi, diseases of, electrocoagulation for, 604
- Bronchial asthma, *see* Asthma
- Bronchial strictures, electrodilataion of, 604
- Bronchiectasis, climate for, 72  
 postural drainage for, 599  
 ultraviolet radiation for, 599-600
- Bronchitis, air-conditioning for, 76  
 climate for, 71-3  
 inhalation therapy for, 77  
 massage for, 329  
 pneumatic chambers for, 76  
 ultraviolet radiation for, 315  
 wet pack for, 48
- Brown, L., 545
- Brown, C. M., 479
- Brucellosis, fever therapy for, 196
- Brunner, M., 167-8, 538
- Bryan, definition of industrial therapy, 427
- Bubble test for polarity of galvanic current, 222, 442
- Buchholz, C. H., 322
- Buckwheat, photosensitizing effects of, 296
- Buerger, L., 527-9
- Bureau of Occupational Therapy, New York State Dept. of Mental Hygiene, 404
- Burner, air cooled, reflector for, 285
- Burns, accidental, from diathermy, 115, 139, 141, 440; from electrical arcing, 114, 197, 439; from electric heating pads, 407; from electrodes, 118; from Elliot apparatus, 407, 532; from ex-

## Burns—(Continued)

- ploding anesthetic mixtures, 439, from exploding lamps, 438, from fever therapy 192, from galvanic currents, 225, 235, 442 from high frequency currents 112 from hot paraffin, 437 from hot water bottles, 48 from infrared radiation 107 from live wires, 444, from melting of lamps, 438, from radiant heat, 107, from short circuits, 437, from short wave current, 154 163, 166, 441, from steam douches, 65, from ultraviolet radiation, 289, from wet dressings with short wave current, 441
- treatment of, by arm and hand baths, 41, by continuous bath, 32, by phototherapy, 106, by ultraviolet radiation, 106, 301

## Bursitis, acute cold compresses for, 475

chronic 476

exercises for, 476

histamine ions for, 235 476

iontophoresis, novocaine for, 237

massage for, 476

paraffin baths for, 23

saline iontophoresis for, 237

short wave diathermy for, 169, 476

subacromial, treatment for, 475-6

subacute, positive galvanism for, 476

traumatic, treatment for, 476-7

## Cabinet bath, electric light, 104

hot air *see* Air, heated

## Cabinets horizontal, for artificial fever, 104, 177-9

air, circulation in, 177, humidity control in, 177

cooling fans with 177

construction of, 178-9

heating of, 104 177-9

## Cables, for electrodes, 157

racks for, 158-9

## Calcinuria, from bed rest, 373

## Calcium deficiency, 290

increase in blood, 290 from ultraviolet radiation, 71, 309 572, in summer, 71

increase in milk 292

loss of, from bed rest 373

parahormone and, 292

physiological antagonism of potassium and, 290, 292

## Calcium—(Continued)

utilization of, 290, 307

vitamin D and, 290

with ultraviolet radiation, for tuberculosis, 546

## Calcium bicarbonate, diuretic effect of, 86

## Calcium ions for hemiplegia, 486

## Calcium metabolism and ultraviolet radiation, 309-10

## Calculi, mineral waters for, 82-3, 86

## Calisthenics, group for ambulatory patients, 410

music, use of, in, 414

## Callosities, 610

## Callus, progress after fracture, 478-9

strength of, 312

ultraviolet radiation for, 280 312

## Camphor liniment to prevent frostbite, 461

Cancer, *see* Carcinoma, Epithelioma, Sarcomas

## Capillaries, constriction of, by cold and rest, 1, 10, to prevent heat loss 11

damaged by artificial fever, 182

dilatation of, and histamine, 15-6 by carbon dioxide gas, 36 by irritants, 11, 15-6, 99 122, chronic, 240, 607, electrolysis for, 240 609 611

edema from pressure in, 13

erythema 288, 303

fragility and vitamin D, 290

in shock, 534

Landes Gibbon test with, 12

physiological changes in 17

skin, and visceral capillaries in balance

13 capacity of 1

triple response of to irritants, 15-6

## Carbohydrates in fever therapy, 183

## Carbon arc lamps, advantages of 283

amperage of, 283

burners, 283

carbon for, types of 282

Corex D filter for, 283

disadvantages of, 284

electrodes for, 282

erythemogenic power, 283

for home use 284

for lupus vulgaris 307

for professional use, 283

mechanism of, 282-3

radiation from 282-3

screens for, 407

- Carbon arc lamps—(*Continued*)  
 special cables, fuses, and wiring for, 283  
 spectral distribution of, 282-3  
 temperature of, 282  
 transformer for, 283  
 ultraviolet spectrum of, 283  
 uvioi filter with, 577
- Carbon dioxide, and oxygen, exchange of,  
 in massage, 321  
 gaseous, alkalosis from loss of, 181; baths,  
*see* Baths, carbon dioxide; in natural  
 springs, 80, 88; inhalations of, and  
 oxygen, 192; tension and hydrostatic  
 effect on, 522  
 solid, effects of, 26; holder for, 608; in-  
 dications for, 609; temperature of, 26
- Carbon electrodes, for arc lamps, composi-  
 tion, 282; sizes of, 283; Sunshine, 282;  
 Therapeutic C, 282  
 for galvanic current, 226
- Carbon filament lamps, apparatus for, 94  
 for bath cabinets, 104  
 for fever cabinets, 104, 178  
 for heating, 94  
 heat tolerance tested by, 99  
 infrared rays from, 20, 94  
 radiation from, 94  
 screens for, 103  
 therapeutic value of, 94  
 wattage of, 94
- Carbuncles, electrosurgery for, 612  
 short wave current for, 612  
 treatment for, 443  
 zinc ions for, 238
- Carcinoma, electrosurgery for, 215-6, 576  
 from ultraviolet radiation, 296  
 ocular, electrosurgery, radium, and x-ray  
 for, 576-7
- Carcinomatosis, ice packs for, 22
- Cardiac cases, aggravated, by brine baths,  
 38; by cold douches, 63; by immersion  
 baths, 438; by Russian baths, 21; by  
 Turkish baths, 19  
 baths for, carbon dioxide, 36-7, 81, 491,  
 523; cold half, 523; hydrostatic effect  
 of, 522; temperature of, 41, 524  
 breathlessness, 522  
 classified, 518  
 climate for, 73  
 exercises for, 38, 517 ff.  
 ice bags for, 524
- Cardiac cases—(*Continued*)  
 massage for, 519  
 rest in bed for, 518  
 terrain cure for, 521  
 therapy for, occupational, 380; physical,  
 518 ff.; spa, 521, 522-4
- Cardiac decompensation, cold compresses  
 for, 53
- Cardiac insufficiency, carbon dioxide baths  
 for, 85, 523
- Cardiac neuroses, 524  
 oxygen baths for, 38
- Cardiovascular changes with artificial fever,  
 180-1
- Cardiovascular disease, carbon dioxide  
 baths for, 85, 523  
 contrast douche contraindicated, 64  
 massage for, 329  
 spa therapy contraindicated, 85  
*See also* Peripheral vascular diseases
- Carlson, A. J., 488
- Caruncles, urethral, electrosurgery for, 217,  
 572
- Cataract, from radiant heat, 107  
 from ultraviolet radiation, 296  
 physical therapy and, 578
- Catarrh, intestinal, mineral waters for, 83  
 of respiratory tract, mineral waters for,  
 83
- Catheter, nasal, in fever therapy, 187
- Cathode, bubble test for, 221-2  
 chemical reactions at, 221  
 for iontophoresis of cations, 230  
 hydrating effect at, 232  
 litmus test for, 223  
 migration, of anions to, 232; of hydro-  
 gen ions to, 232  
 physiological effects at, 224, 232  
 pole of galvanic current, 221
- Cations in mineral waters, 79
- Caulk cautery for prostatic obstruction,  
 557
- Cauterization, effect of, 199-200
- Cawadias, A. P., 306
- Cellulitis, arm and hand baths for, 41  
 of orbit, treatment for, 576  
 pelvic, diathermy for, 566  
 ultraviolet for, 315
- Cerebral cooling by conduction, 8
- Cerebral edema, from radiant heating, 515  
 in fever therapy, 192-3

- Cerebral heating conductive, 8  
 diathermy 230 487
- Cerebral hemorrhage, *see* Hemiplegia
- Cerebral palsy, 488
- Cerebral shock electric, for psychoses, 513
- Cerebral tumors, 487, 578
- Cerletti, U, 513, 516
- Cervical stenosis, dilatation of, 572
- Cervicitis, contraindications to treatment, 571-2  
 copper ions for, 571  
 electro-surgery for, 571-2  
 mercury ions for, 571  
 zinc ions for, 571
- Cervix uteri, carcinoma of, electro-surgery for, 572  
 conization of 570  
 erosion of, electrocoagulation and mercury ions for, 571  
 papillomata of, electro-surgery for, 572
- Chalazion, curettage for, 576  
 electrocoagulation for, 214, 576  
 massage for, 579
- Chancres electro-surgery for, 217
- Chancroid, argyrol crystals for, 556  
 electrodesiccation for, 217, 527  
 fulguration for, 557
- Chemical effects, at anode, 222  
 at cathode 222  
 from iontophoresis, 231  
 from skin irritation, 15  
 from temperature changes 15  
 from ultraviolet radiation 290-3
- Chemical heating bags, 23, 25
- Chemotherapy, and fever therapy, 184, 189, 190, 193  
 by iontophoresis, 233-6  
 with fever therapy, in syphilis, 194  
 with ultraviolet radiation 296-7
- Cheyne Stokes breathing 71
- Chickenpox air sterilization as preventive, 298  
 ultraviolet for, 299
- Children, irritability in, ultraviolet radiation for, 316
- Chills cold baths contraindicated, 34
- Chinese use of hot springs for therapy 173
- Chlorides, gastric, in fever therapy 181-2  
 in circulatory collapse 194  
 in urine, with fever therapy 182  
 loss of, in fever therapy, 81, 181-2
- Chlorides—(Continued)  
 serum, in fever therapy, 181-2
- Chlorine ions, for keloids, 610  
 for softening scars, 237  
 from cathode, 236
- Chlorophyll, as sensitizer to radiation, 297
- Choke coil, action of, 269
- Cholagogue, mineral waters for, 82-3, 86
- Cholecystitis, diathermy for, 540
- Cholelithiasis, diathermy for, 540
- Choline ions, solution for, 236
- Chor, H, muscle atrophy from nerve injury, 266-7
- Chorea, fever therapy for, 190 196, 488  
 massage for, 329  
 occupational therapy for, 380
- Choroiditis fever therapy for, 197  
 ultraviolet radiation for, 578
- Christie R V, 124 128
- Chromotherapy, for lupus erythematosus, 106-7  
 for smallpox, 106  
 psychic effects of, 107
- Chronaxie defined, 260  
 of muscles, 260  
 rheobase in, 260  
 technique of determining, 260
- Chronaximeter, 260
- Chrysophanic acid, as photosensitizer, 296
- Cipollaro, A C 313 317-8, 607
- Circuit electrical heating in, 123, 125-6  
 in galvanic machine 223  
 oscillating diathermy, 109-11, short wave 139  
 patients in diathermy 114 with direct current, 223, with faradic current, 261 with short wave 140
- Circulation, body temperature modified by, 13 19  
 hydrostatic effects of baths on, 482, 522  
 impeded effect on temperature and diathermy, 124  
 in gums after massage 536  
 in skin, during carbon dioxide baths, 36  
 during fever therapy, 184  
 insufficient, heating for 408, pain with, 11, 530 sensitivity from 27  
 modified by carbon dioxide baths 37, 492, by cold, 26, by diathermy, 135  
 by exercise, 331-2 by heat, 11, 16-7  
 by massage, 321-2

- Circulation—(*Continued*)  
 of air, in cabinets, 177; for cooling, 22, 26, 185, 190  
 of blood, during artificial fever, 191; during active exercise, 331  
 of lymph, in whirlpool baths, 43  
 of water, in cooling and heating coils, 25; in whirlpool baths, 43  
 poor, whirlpool baths for, 43  
*See also* Peripheral vascular diseases
- Circulatory collapse, chloride in, 193
- Circulatory disorders, acetylbetamethyl choline chloride ions for, 452  
 arm and hand baths for, 41  
 carbon dioxide baths for, 84, 523  
*See also* Cardiovascular diseases; Peripheral vascular diseases
- Circumcision by electrosurgery, 217
- Circumoral pallor, 187
- Circumvallation, 218
- Clamp electrode of Corbus, 122
- Clark, E. R., 322
- Clark, W. L., 201, 209
- Claudication, alternating air pressure for, 530  
 passive vascular exercise for, 530
- Clausen, E. M. L., 99
- Claustrophobia during therapeutic fever treatment, 187
- Clay modeling in occupational therapy, 375
- Climate, artificial, 75; *see also* Air-conditioning  
 components of, 67  
 gulf coast, 72  
 marine, 73  
 regional variations, 67  
 relation, to bodily activities, 69; to disease, 69  
 seasonal variations of, effect on physiological activities, 69, 72  
 solar rays and, 273  
 southern United States, 72  
 therapeutic use of, 72 ff.  
 value of, 72  
 weather and, 67
- Cloetta, M., 124, 487
- Clothing, and heat loss, 69
- Clotting time, and vitamin D, 292
- Clover, and photosensitivity, 296
- Coblentz, W. W., 275, 285, 287
- Cocaine, for neuritis, 237
- Coccygodynia, massage for, 327
- Cock-up splint for contractures, 485
- Coil, Bristow, 261  
 cooling, 25  
 faradic, 261  
 heating, 25  
 induction, 168-9  
 pancake, 157-9  
 spiral, 158
- Cold, and heat, effects of, 17; precautions with, 26-7  
 common, mustard bath for, 41; ultraviolet radiation for, 580-1  
 conductive, analgesia by, 22, 26  
 anesthesia by, 26, 433, 480 ff.  
 effects of, 2, 3, 6-13, 15, 17-9, 22, 26, 68, 433, 575  
 methods of application, compresses, 26, 48; evaporation, 39, 188-9, 193; ice, 22, 25-6; immersion baths, 34, 39, 44; solid carbon dioxide, 26, 608  
 convective, *see* Air, cold; Baths, continuous  
 effects of, 13  
 hypersensitivity to, 16  
 indications for, 475, 477, 533  
 injuries from, frostbite, 593; to arterioles, 10  
 mechanism to combat, 2  
 penetration of, 4-5, 536, 553  
 refrigeration by, indications for, 21, 22, 480-1, 483, 523; systemic temperature during, 6, 22  
 sensation, 29  
 temperature of, 2, 10  
 test for hypertension by, 13, 14  
 vasoconstriction by, 3, 15; peripheral, 12
- Cold air, 7
- Cold compress, indications for, 52, 524, 533
- Cold quartz lamps, 285  
 bactericidal power, 285  
 characteristics of, 285  
 indications for, 285  
 operation of, 285  
 spectrum, 607  
 spiral, 285  
 value of, 285, 286
- Cold therapy, contraindications for, 31, 33, 41, 63, 461, 534

- Cold therapy—(Continued)  
 indications for, 21, 22, 26, 41, 45, 47, 475,  
 480, 483, 524, 536, 575, 608  
 See also Baths
- Colds, baths for, 21  
 See also Sinusitis
- Colic, heat for, 33  
 ureteral, thermotherapy for, 558
- Colitis, enemas for, 540-1  
 heat for, 541  
 iontophoresis for, 238  
 Morgan's method for, 540-1  
 mucous massage for, 329  
 occupational therapy for, 383  
 ultraviolet radiation for, 312  
 vibration for, 541
- Collens, W S, 530
- Colloids effect of short wave on, 150
- Colonic irrigations, effects of, 544  
 indications for, 455 540-1  
 materials for, 543  
 mineral waters for, 81  
 solutions for, 544  
 technique, 543-4  
 temperature of, 544
- Communicable diseases, acute, massage  
 contraindicated 330
- Compresses, cold, wet, duration of applica-  
 tion, 26, 53 effect of 48 indications  
 for, 48-53 reaction to, 53 technique  
 48-53, temperature of, 48 53 varia-  
 tions of, 53  
 cold heating 53  
 hot, to epigastrium, 540  
 hot wet, duration of application 53-4  
 468 heating of 53 55 materials for,  
 53 55 467, reaction to, 55 498 tech-  
 nique 53-5, 497-8, temperature of, 55,  
 498 see also Fomentations Turpen-  
 tine stupes
- Conception, temperature test for, 6
- Condenser electrodes, coil, 157  
 cuff 155 157  
 drum 159  
 flexible, 153-5  
 glass, 147  
 glass shoes for, 153-4  
 guards for, 153-4  
 mask, 116  
 orificial 160  
 pancake coil, 157, 159
- Condenser electrodes—(Continued)  
 plate, 151, 154  
 spiral, 157-8  
 tank, 161
- Condenset field technique, 151-3
- Conductive cold, see Cold, conductive
- Conductive heat, see Heat, conductive
- Conization by cutting current, 570
- Conjunctivitis, acute, 577  
 chronic, ultraviolet radiation for, 312  
 from photo-allergy, 295  
 from ultraviolet radiation, 289  
 vernal, 295, 577
- Constipation, atonic, cold for, 45  
 exercises for, 541-2  
 faradic current for, 261  
 from bed rest, 373  
 massage for, 329  
 mineral waters for, 82-3, 85  
 sitz bath for, 45  
 spastic, diathermy for, 541
- Contractures, chlorine ions for, 237  
 Dupuytren's, 475  
 faradic current for, 475  
 massage for, 475  
 negative galvanism for, 237 475  
 phototherapy for, 104-5  
 prevention of, in paraplegia, 414  
 splints for, 474  
 surgery for, 475  
 Volkmann's ischemic, 475  
 whirlpool bath for, 475
- Contrast bath see Baths contrast
- Contusions arm and hand baths for, 41  
 contrast baths for, 41-2  
 hot air baths for, 21  
 short wave current for 169
- Convalescence, marine climate for, 73-4
- Conversive heating long and short wave  
 diathermy in, 109
- Cooling and fever therapy, 188-9  
 conductive and heating compared, 8  
 effect of 26  
 means of, ablutions 46 affusions, 46  
 alcohol, 188 193-4 cold water, 20,  
 compresses, 48 electric fans, 188-9  
 ethyl chloride, 26, ice, 22, sitz baths,  
 45 water, 61-2, 188, wet sheets, 46  
 wet towels, 20
- Copeman on fat herniation, 460



- Coplanar technique for electrodes, 149, 155-6
- Copper ions, from anode, 234  
indications for, 234, 235, 236, 237-8, 549, 571
- Corbus, B. C., 122
- Cord knotting in occupational therapy, 385
- Corex D glass, 283, 289
- Cornea, transparent to ultraviolet rays, 575
- Corneal scars, 577
- Corneal ulcers, electro-surgery for, 216  
fever therapy for, 197  
iontophoresis for, 238  
massage for, 579  
ultraviolet radiation for, 312  
zinc ions for, 238, 579
- Corning glass filter, 295
- Coronary occlusion, carbon dioxide baths  
contraindicated, 523
- Coronary sclerosis, carbon dioxide baths  
contraindicated, 523  
cord knotting for, 484-5
- Corpora cavernosa, thermotherapy for, 556
- Correspondence courses in educational re-  
training, 427
- Coryza, air-conditioning for, 75
- Cosine law for radiation, 302
- Cosmic rays, 92
- Coulomb, 220
- Coulter, J. S., 141, 322, 546
- Council on Foods, A.M.A., 292
- Council on Physical Therapy, A.M.A., 150, 285, 288, 316, 341, 435
- Counselor, V. S., 532-3
- Counterirritants, galvanic current, 224  
infrared radiation, 96  
mustard, 41, 56  
paprika, 25  
ultraviolet radiation, 312
- Coxa vara, heliotherapy for, 280
- Cramps, intestinal, phototherapy for, 105  
muscular, massage for, 328  
uterine, phototherapy for, 105
- Crossman, L. W., 480-3
- Crown breeze, 273
- Crutch paralysis, treatment for, 443 ✓
- Crutch walking technique, 416-7
- Crutches for paraplegics, 415-7
- Crystalline lens, fluorescence of, 291
- Cuff electrodes, 118, 155, 157
- Cumberbatch, E. P., 121, 135, 137, 224
- Curare, in Kenny poliomyelitis technique, 502
- "Cure crisis," 81
- Currence, J. D., 34
- Currents, air, 67  
electric, alternating, *see* Alternating cur-  
rent; combined, 269; constant, *see* Gal-  
vanic current; cutting, *see* Cutting  
current; density, limits of, 119; dia-  
thermy, *see* High frequency current;  
direct, *see* Galvanic current; displace-  
ment, 141; faradic, *see* Faradic current;  
for passive exercise, 258-60, galvanic,  
*see* Galvanic current; high frequency,  
*see* High frequency current, induction,  
163; Lopicque, 262; Leduc, 262; motor  
generators for, 109, 211; rectification  
of, 223; short wave, *see* Short wave  
current; sinusoidal, *see* Sinusoidal cur-  
rent; static, 270; strength of, for chro-  
naxie, 260; testing, for polarity, 221-2,  
270-1
- Curvature of spine, 356-8
- Cutaneous infections, mineral baths for, 86
- Cutler's solution, 613
- Cutting current for electro-surgery, 211-2  
circuit for, 113  
electrode for, 211-2  
technique, 211-2, 218
- Cyanine, a photosensitizer, 296
- Cyanosis, affected by heat, 15  
cold baths contraindicated, 34  
in fever therapy, 187
- Cyclopropane, explosive with electric  
sparks, 439
- Cystitis, mineral waters for, 86  
thermotherapy for, 556  
transurethral ultraviolet radiation for,  
315, 556
- Cysts, sebaceous, electro-surgery for, 610
- Dannreuther, W. T., 572
- Deafness, 423-4; *see* Aural disability  
Bech's method with diathermy, 595  
hysterical, 512
- Debility, cold baths for, 34  
continuous baths contraindicated, 32  
iron mineral water for, 83  
Russian baths contraindicated, 21  
spa therapy for, 86

- Decompensation, carbon dioxide baths con-  
traindicated, 38, 492
- Deformities, from poliomyelitis, 494  
functional, 356-9  
permanent, from thoracic surgery, 425  
structural, 356-9  
test for, 356
- Degeneration, reaction of, 256-66  
test for, 267  
Wallerian, 264
- Dehydration, during fever therapy, 181,  
185 193  
in electrodesiccation 203  
treatment for, 193
- Delirium, during fever therapy, 193  
treatment of, 193  
wet pack for, 48
- Delthil, P 604
- Dementia paralytica fever therapy for, 195
- Denervated muscle, atrophy from, 491  
treatment of 491-2
- Dental infections, test for, 536-7  
treatment by short wave, 537
- De Rivas D, 544
- Der Brucke M, 566-9
- Dermatitis, continuous baths contraindi-  
cated, 32  
of eyelid, x ray for, 576
- Dermatitis herpetiformis, ultraviolet radia-  
tion contraindicated, 295
- Dermatitis solaris chronica epithelioma  
from, 295
- Dermatological diseases, 606 ff
- Derow, D 551, 571
- Desensitization, to cold hypersensitivity, 16  
to ragweed, 239
- Desquamation after sunburn 289
- Diabetes, and climate, 69 73  
ultraviolet radiation contraindicated 316
- Diabetic gangrene, prevention of by mas-  
sage 329
- Diabetics, 371-2
- Diagnosis 445  
by fluorescence 294-5
- Diaphoresis, half baths for, 39  
light baths for, 106
- Diathermy, accidents with, 438-42  
and electrical exercise, 268-9  
compared with short wave 141-2  
contraindications 133-6  
distribution of current in body, 141-3
- Diathermy—(Continued)  
electrodes for, 114-22, special, 205-08  
heating effect of, 170-1  
high frequency current for, 138  
indications for, 133-6 465, 476, 525-6,  
539 541, 546, 600  
machine for, 109-13, fuses for, 113,  
operation of, 111-2, panel board for,  
110, 112, rotary converter for, 111  
physiological effects of, 122-5  
precautions with, 438-42  
surgical, advantages, 215-6, disadvan-  
tages, 216, electrocoagulation, *see* Elec-  
trocoagulation electrodesiccation, *see*  
Electrodesiccation fulguration 199  
indications for, 216-7 principles of,  
199 technique, 199-204 211-2, tissue  
changes, 209-11  
technique of treatment by, abdominal  
organs 128, adapted to part and struc-  
ture, 125 angina pectoris, 128, ankle,  
133 arm 130 back, 132, body, 132,  
brain, 125 487 coplanar, 128, 132  
ear, 126-7 elbow, 130 eye, 125-6,  
face, 126 finger, 130 head, 125 hip,  
130-1, knee 131 larynx, 128, leg,  
131-2 lumbosacral region 132, neck,  
128, pelvis, 128 191, shoulder, 128-9,  
sinuses, 126 spine, 132 thigh, 131  
wrist 130
- Dielectric of air, 140  
of body, 141  
of water, 140-1
- Dielectric constant 140-1
- Diet photodynamic substances in, 296
- Dionin, for corneal scars, 577
- Direct current *see* Galvanic current
- Disabled prosthesis, proper fit for, 411
- Disc electrode, for electrocoagulation, 248
- Disinfection, by ultraviolet, 299
- Dislocations, brine baths for, 38  
massage after 327  
phototherapy for, 104-5
- Disodium arsenate in mineral springs 87
- Disorientation during fever therapy, 187
- Displacement current, 141
- Diuresis after massage, 321
- Diuretics, mineral waters as, 85-6
- Doan C A 174
- Douches action of, 56-65  
Aix, 64

- Douches—(Continued)  
 cold, 62-3  
 contrast, 63-4  
 control table for, 61  
 defined, 56  
 effects of, 61  
 eliminative, 62  
 fan, 61  
 for neurovascular training, 61  
 hot, 63  
 indications for, 62-5  
 irrigating, 65  
 pressure of, 56  
 reducing, 61  
 Scotch, 63-4  
 showers, 56  
 steam, 65, 533  
 Vichy, 64
- Doyen, E. L., 206
- Drafts, effects of, 7
- Drip sheet, 46
- Drugs, photosensitizing, treatment by, 296-7  
 photosensitivity to, 296; rashes from, 297
- Drum electrode, 157, 159, 161
- Drury, A. N., 13
- Dry ice, *see* Carbon dioxide, solid
- Duke, W. W., 295
- Dunn, F. L., 196
- Dunton, W. R., Jr., 403
- Duodenal bleeding, diathermy contra-  
 indicated, 136
- Duodenitis, saline mineral water for, 82
- Dupuytren's contracture, 475
- Dyes, photosensitization by, 296  
 photosensitizing, administration of, 297
- Dysmenorrhea, exercises for, 573
- Dyspepsia, alkaline effervescent drink for, 82
- Dyspnea, carbon dioxide and oxygen in-  
 halation for, 77, 192  
 during fever therapy, 192
- Ear, diseases of, diathermy for, 126-7  
 phototherapy for, 593  
 short wave current for, 593-4  
 tin ions for, 591  
 ultraviolet radiation for, 592  
 zinc ions for, 593
- Ebaugh, F. G., 189, 194
- Eclampsia, ultraviolet radiation for, 313
- Eczema, alkaline mineral water for, 82  
 cabinet baths for, 20  
 chronic, bland baths for, 608; radiant  
 heat baths for, 20  
 fever therapy for, 196  
 from photo-allergy, 295  
 iontophoresis for, 238  
 moist dressings contraindicated, 592  
 sulfur baths for, 86  
 thermal saline waters for, 83  
 ultraviolet radiation contraindicated, 295,  
 607, 613
- Edema, angioneurotic, from photo-allergy,  
 295  
 chronic, whirlpool baths for, 43; during  
 fever therapy, 191-2  
 from increased capillary pressure and  
 heat, 13  
 lung, from bed rest, 373  
 of fat, as cause of fibrositis of back,  
 460  
 pregnancy, massage for, 329
- Edstrom, G., 124
- Education of tuberculous patients, 425-6
- Educational retraining in rehabilitation,  
 427
- Effleurage, 323
- Eidinow, A., 312-3
- Elastic supports, 453
- Elbow joint, exercises for, 339, 389, 391-5  
 injuries, treatment of, 462
- Elder, H., 297
- Electric arcs, 282-4
- Electric blankets, 25
- Electric circuits, faradic, 260-2  
 galvanic, 221  
 high frequency, diathermy, 110; short  
 wave, 130 ff.  
 static, 270-3
- Electric exercise, by faradic current, 261-2  
 by sinusoidal current, 262  
 by static condenser discharges, 270-1  
 by static induced current, 272-3  
 contraindications for, 270  
 effect on heating, 269  
 indications for, 267, 269, 465, 474, 476,  
 503, 541  
 technique, 268  
 with diathermy, 269
- Electric fans, 188-9
- Electric heater, 95-6

- Electric light, baths, *see* Baths, radiant heat  
 bulbs, 92, 94-5  
 cabinet, 104
- Electric pads 25
- Electric shock, accidental, 443-4  
 first aid for, 444  
 therapy, for psychoses 513-4
- Electrical stimulation, to delay muscle atrophy, 267
- Electrical treatment of muscular atrophy, 267
- Electrocauterization, 199-200
- Electrocoagulation, anesthesia for, 209  
 diathermy current for, 205  
 electrodes for 205-8, 246-8 258  
 hemostatic action of, 206  
 indications for, 211, 541, 547  
 technique, 205-6, 209 biterminal 206  
 tissue changes, 204-6, 209, 211  
 with zinc copper and mercury ions, 571
- Electrode, active, for electrocoagulation, 206 for electrolysis, 240  
 asbestos pad, 225  
 ball, for static spark, 270-1  
 belt, 118  
 biterminal, 206-8  
 drum, 157, 159  
 finger, for ear diathermy, 126-7  
 fixation of, 119 122  
 for arc lamps, 282  
 for brush discharge, 272  
 for cutting current, 211-5  
 for desiccation, 201-2  
 for electrical testing 226  
 for fulguration, 199-201  
 for galvanic current 225, bath, 226-7  
 for galvanic treatment, 226  
 for high frequency current, clips, 114-5, plate 115  
 for iontophoresis 226  
 for short wave treatment cuff 118, 155, 157, cup shape 552, direct contact, 160-1 orificial, 160 pancake coil, 157, 159 rectal 162, spacing of 160 163, spiral coil 157-8  
 glass condenser, 122, for vaginal heating, 147  
 induction, technique of application, 163  
 metal, 126, 225-6, 625  
 orificial, 119 for pelvic heating 146-7  
 pancake coil 157, 159
- Electrode—(Continued)  
 plaster cast, 115-7, 120  
 plate, 115, 118, for static wave 270  
 positive, in arc lamps, 282, temperature of, 282  
 rectal, 119, for short wave, 162  
 rod, 119, 122  
 salt water, for diathermy of fingers, 130  
 Schnee bath 226-7  
 spacing of, 160, 163  
 suction for electrocoagulation, 207, 589-90  
 urethral, disadvantages of, 121-2  
 vaginal, 119-21, 147-8, for iontophoresis 566-9, holder for, 121, 124  
*See also* Condenser electrodes
- Electrodesiccation, advantages of, 204-5  
 anesthetic for, 203  
 current for, 201  
 dehydrating effect of, 203  
 electrode for, 201  
 indications for, 204-5  
 postoperative care, 204  
 technique, 201-4  
 terminal for, 199-200  
 tissue changes, 201
- Electrodiagnosis, 246, 248, 258, 260  
 of motor nerve injuries, 489
- Electrogalvanic surgery, 239
- Electrolysis, indications for, 236-9, 240, 555, 579, 604 609 611-2  
 of salt solution, 222
- Electrolytes 224
- Electromagnetic spectrum, 91-3
- Electromagnetic waves, measurement of, 92-3
- Electromechanical currents, faradic, 260-2  
 sinusoidal, 262  
 static charge, 270-3
- Electromotive force, 220-1
- Electro-osmosis, with galvanic current, 222
- Electrophoresis, 232
- Electrosurgery advantages of, 215-6  
 amperage for, 220  
 by cutting current, 211-6  
 disadvantages of 216  
 electrocoagulation for, 209  
 healing time after, 216  
 indications for, 216-9  
 transurethral, 217
- Electrotonus, 224

- Elimination, by baths, 21, 38  
of temperature gradient, 98  
phototherapy for, 106
- Ellinger, F., 290
- Elliot apparatus, burns from, 437  
modified for hot air, 562
- Elliot method, for pelvic heating, 562  
for sinusitis, 585
- Ellis, J. D., 216
- Emboli, alternating air pressure for, 530  
cardiac, carbon dioxide baths contra-  
indicated, 523  
massage contraindicated, 531
- Embolism, pulmonary, from bed rest, 373
- Emphysema, air-conditioning for, 76  
high altitudes dangerous, 75  
pneumatic chambers for, 76
- Empyema, blowing exercise for, 600  
continuous suction, 600  
incision and drainage, 600  
irrigation, 600  
ultraviolet radiation for, 313
- Encephalitis, ultraviolet in, 315
- Endocarditis, fever therapy for, 197, 524  
gonococcal, fever therapy for, 524
- Endocervicitis, copper ions for, 236, 238,  
571  
electrosurgery for, 570  
zinc ions for, 238
- Endocrine disorders, ionized air for, 77
- Endometriosis, electrosurgery for, 217
- Enemas, for colitis, 540-1  
in fever therapy, 183  
in paraplegia, 414
- Energy, distributed in solar rays, 281  
radiated by flaming carbon arc, 282
- Entropion, electrosurgery for, 216
- Environment, adaptability of human or-  
ganism to, 2
- Enzymes, effect of ultraviolet radiation on,  
299
- Eosin, photosensitization by, 296
- Epidermis, 96-7
- Epididymitis, Corbus electrode for, 122  
diathermy for, 555  
short wave for, 555  
sitZ baths for, 555
- Epilation, polarity of electrode for, 442
- Epinephrine, for allergy, 238  
for asthma, 601  
for iontophoresis, 601
- Epiphysiolysis, heliotherapy for, 280
- Episcleritis, ultraviolet radiation for, 312
- Epistaxis, 580
- Epithelial vessels, 15
- Epithelioma, electrosurgery for, 612  
from dermatitis solaris chronica, 295  
from ultraviolet radiation, 295, 317  
radium for, 612  
x-ray for, 612
- Epstein, on chemotherapy and fever  
therapy in syphilis, 195
- Epulis, electrodesiccation for, 205
- Erb's sign, 266
- Erysipelas, of auricle, ultraviolet radiation  
with sulfanilamide, 592  
of nose, phototherapy for, 579; ultra-  
violet radiation for, 579  
phototherapy for, 106  
ultraviolet radiation for, 106, 615
- Erythema, histamine-like substances, 321;  
lamps, 287-9; massage, 321-2; radiant  
heat, 99; solid carbon dioxide, 26;  
ultraviolet radiation, 273, 303; wave  
lengths, 273, 291  
dose, standardization of, 303-4
- Erythema induratum, electrosurgery for,  
613
- Erythemogenic power, of carbon arc lamps,  
283  
of lamps, 291
- Erythrocytes, during artificial fever, 181
- Ethyl chloride anesthesia, 461
- Ethylene, explosive quality of, with electric  
spark, 209, with high frequency cur-  
rent, 439
- Ewalt, J, 191-2, 194
- Exercise, active, blood pressure and, 332;  
breathing and, effects of, 331; heat  
loss with, 332  
group, 334  
heating on termination of, 436  
in aphasia, 420  
in bed, 466, 500, 510  
in occupational therapy, *see* Occupational  
therapy, exercises in  
in paraplegia, 414-5  
in rheumatic fever, 374  
in tuberculosis, 425  
indications for, 476  
mechanical devices for, 339-40  
muscle setting in paraplegia, 415

- Exercise—(Continued)*  
 passive, Sanders rocking bed, 528, *see also* Electric exercise  
 postoperative, 466, results of, 387, 389  
 postpartum, 573  
 prescription of, 332, 436  
 preventing lordosis in amputees, 419  
 stretching, 368, hamstring, 365  
 temperature after, 4  
 therapeutic, classified, 334, 336  
 under water, contraindications for, 33, indications for, 33, 454, 476, pools for, 32-3, tanks for, 32-3  
 vasodilatation by, 3  
 with bicycle jigsaw, 395, 397
- Exercises, for amputees, 419  
 in thoracic surgery convalescents, 425  
 stump, 419
- Explosion of anesthetic, with electro-surgery, 209  
 with high frequency treatments, 439
- Extravasations, massage for, 327
- Extremities, protection of, against cold, 2  
 temperature of, 2  
 volume of, affected by temperature, 13
- Extremity, loss of, 413
- Exudates, absorption of sitz baths for, 45  
 brine baths for, 84  
 oven baths for, 21  
 treatment for, 84
- Exudation from arterioles, 10
- Eye, artificial, 422-3  
 diathermy for, 125-6  
 diseases of, fever therapy for, 578-9  
 physical therapy for 575-8, short wave current for, 578-9  
 injury to, from incandescent arcs, 407  
 loss of vision in one, 421-2  
 media of, transparent to ultraviolet radiation, 575  
 protection of from ultraviolet rays 305, 306  
 sensitivity to light, 107, to ultraviolet radiation 288  
 ultraviolet lamp for, 576
- Eye shades for radiation treatments 101
- Face, swelling of, cold for, 536
- Facial paralysis *see* Bell's palsy
- Fagopyrism 296
- Fahnestock spring clip for high frequency electrodes, 114-5
- Falling hair, photodynamotherapy for, 297
- Faradic coil, 261
- Faradic current, 260-2  
 action of, 260  
 duration of, 261  
 source of, 260-1  
 surging, 261
- Faradic generator, 635
- Farming, in rehabilitation, 427
- Fascia, stretching exercises for, 369
- Fascia lata, 470
- Fat, effect of massage on, 322  
 fluorescence of, with ultraviolet radiation, 294  
 heating, by diathermy, 123, by short wave, 141, 145
- Feebleness, cold baths contraindicated, 33-4
- Feet, disorders of, 358-60, mustard foot baths for, 41  
 flat, treatment for, 435, 464-5  
 injuries to, 462, 464-5, treatment, 462, 464  
 Morton insole, 464  
 treatment by short wave current, 449  
 weak, causes of, 358, exercises for, 354-5, 359-60, signs of, 359
- Ferderber, M B, 76
- Ferments, effect of ultraviolet radiation on, 299
- Ferree J W, 75
- Fever, ablutions for, 46  
 cold for, 22  
 physically induced, 173-5  
 production of, by hot baths, 173-5 by short wave current, 457, by ultraviolet radiation 316  
 psychogenic, 513
- Fever therapy, alternative for chemotherapy, 194  
 autocondensation for, 133  
 cabinet baths for, 177-9  
 claustrophobia during 187  
 complications with 189-94  
 diet in preparing patient for, 183  
 dyspnea during, 192  
 fluids administration of during 185-6  
 indications for, 194-7, 455-6, 488, 493,

- Fever therapy—(*Continued*)  
 indications for—(*Continued*)  
 509, 549; in syphilis, with chemotherapy, 194; with x-ray, for malignancy, 196-7  
 in gonorrhoea, sulfapyridine, use of, 194  
 narcotics during, effect of, 184-5  
 nasal catheter in, 187  
 nursing during, 182-3, 191  
 oxygen, use of, in, 187  
 precautions during, 189-91  
 preparation of patient for, 183-4  
 radiant heat baths, 20, 177-9  
 reactions to, 189-91  
 salt, administration of, during, 185-6  
 shock during, treatment of, with blood plasma, 194  
 technique, 182-3; during stage of decline, 188-9; during stage of temperature elevation, 184-5; during stage of temperature maintenance, 185-6  
 temperature determination during, 180  
 termination of, 188-9
- Fibrosis, galvanic current for, 491
- Fibrositis, as cause, of sciatica, 460  
 baths for, brine, 38; cabinet, 21; hot vapor, 84; mud, 23; paraffin, 23; sitz, 45  
 causes of, 457-8  
 classified, 457-8  
 contrast douche for, 64  
 dry cupping for, 459  
 herniation of fat in, 460  
 histamine ions for, 237  
 low back pain from, treatment of, 467, 470  
 massage for, 328, 470  
 nature of, 457-8  
 phototherapy for, 104-5, 459  
 physical therapy for, 458-9  
 rheumatoid, treatment for, 443  
 saline iontophoresis for, 237  
 static wave for, 271  
 structures involved in, 457-8  
 synonyms for, 457  
 thermal mineral waters for, 84  
 vibration for, 458
- Fibrositis of back, removal of herniation as relief for, 460
- Films, motion picture, for rehabilitation of amputees, 409
- Filter, Corex D, 283  
 Corning glass, 295  
 Wood's glass, 289
- Fingers, exercises for, 401  
 electrodes for ear diathermy, 127  
 joints of, exercises for, 338
- Finsen, N. R., 310, 606
- Finsen unit of dosage for ultraviolet radiation, 289
- First aid for electric shock, 444
- Fisher, E., 267, 444
- Fissure in ano, dilatation and diathermy for, 547-8  
 electrodesiccation for, 547  
 electrosurgery for, 217  
 iontophoresis for, 238
- Fistula, anal, electrosurgery for, 217, 548  
 iontophoresis for, 238  
 tuberculous, ultraviolet radiation for, 558-89
- Fitch, W. E., 81, 87
- Flaccid paralysis, Leduc current for, 262
- Flatulence, abdominal packs for, 56  
 alkaline mineral waters for, 82  
 sitz baths for, 45
- Flatus, abdominal massage for, 328
- Fluids, administration of, during fever therapy, 181, 185-6
- Fluorescence, bactericidal effect with ultraviolet radiation, 298  
 colors distinctive for tissues, 294  
 detection of, 294  
 diagnostic method, 294  
 to determine blood velocity, 295  
 visible by Wood's glass, 289, 295
- Fluorescein, photosensitization by, 295
- Fomentations, hot, for gastritis, 539  
 for poliomyelitis, 497  
 for sprains, 465
- Fractures, baths for, brine, 38; contrast, 42; oven, 21; paraffin, 23  
 callus formation, 478-9  
 effect of heat, 478-80  
 exercises for, 478-80  
 massage for, 327-8, 478-80; effect of, 478-80  
 phototherapy for, 105  
 physical therapy, contraindicated, 479  
 ultraviolet radiation for, 280, 312
- French Lick Springs, 87-8

- Frequencies, federal standards for, in diathermy, to combat interference, 171
- Freude, E, 11
- Friction massage, 324-5
- Fritz, H, 456
- Frost bite, alternating air pressure for, 530  
critical temperature for, 10  
delayed by vasoconstriction 10  
prevented by camphor liniment, 461  
treatment of, 534
- Fulguration, 199-201
- Functional disorders sheet baths for, 46
- Functional hepatic disorders mineral waters for, 83
- Fungus infections, 237-8  
copper ions for, 238  
silver ions for, 238, 615  
ultraviolet radiation ineffective, 616
- Furuncles, electrodesiccation for, 612
- Furunculosis, ultraviolet for, 315
- Gaenslen, F J, 340
- Gall bladder, chronic disorders, mineral waters for, 83
- Galvanic current, 220 ff  
burns from 442  
chemical effects of, 221-3  
continuous, 220  
dangers of, 226-7, 442  
dosage, 228-9  
electrodes for, 225-6  
erythema from, 224  
generator, low voltage, 633  
indications for, 229-30, 236-9, 240, 267, 450, 452-3, 491, 509  
interpolar action of, 224  
interrupted, action of, 246-68, electrodes for, 246-8 for atrophic arthritis 453  
for diagnosis, 220, 246, 248, 258, 260  
for muscle tests, 246 248, muscle contraction from, 266  
meter for, 228  
nature of 220  
pain relieving influence of, 224  
physics of 220-3  
polarity tests for, 221-2, 231, 273  
rectification for, 223-4  
sources of, 223-4  
technique 225-9  
treatment with, 225-9, precautions, 442-3
- Galvanic machine, 442-3
- Gamma rays from radium, 92-3
- Ganglion of tendon, treatment for, 474
- Ganglionectomy, and changes in temperature, 10
- Gangrene, alternating air pressure for, 530  
diabetic, massage as preventive, 329  
exercise for, 372  
prevention of, 526, cold for, 21-2  
regime for, 372
- Gas tension, effect of temperature rise on 16
- Gastric atony, faradic current for, 539
- Gastric bleeding, diathermy contraindicated, 136
- Gastric catarrh, chronic, mineral waters for, 83 85, physical therapy for, 540
- Gastric chlorides, in artificial fever, 182
- Gastric dyspepsia, mineral waters for, 82
- Gastric hyperacidity, mineral waters for 85
- Gastric lavage, for gastritis, 539 for pyloric spasm, 538
- Gastric neuroses, converse heating for 539
- Gastric peristalsis, effect of cold, 11
- Gastric secretion and barometric pressure 70 effect of cold or heat, 8
- Gastritis, diathermy for, 539  
heliotherapy for, 539  
mineral waters for, 82  
ultraviolet radiation for, 539
- Gastro-intestinal catarrh, mineral waters for, 82, 85
- Gatch W D, 534
- Gauvain, Sir Henry, 74
- Gelotripsie, 460
- Genito-urinary disorders, spa therapy for 86
- Gibson, J G, 180-1, 185
- Glands of Bartholin electrosurgery for 218, 572
- Glass, Corex D, 283 289  
special for solaria 289  
uvviol, 281  
vita, 281
- Glasses, dark, contraindicated in blindness 423
- Glaucoma, diathermy contraindicated 576
- Glucose intravenous during fever therapy 194



- Goggles, protective, for ultraviolet radiation, 632
- Goiter, exophthalmic, carbon dioxide baths contraindicated, 523
- Gold, a photosensitizer, 296
- Goldschmidt, S., 16
- Gonacrin, photosensitization by, 296
- Gonococcal arthritis, *see* Arthritis, gonococcal
- Gonococcal endocarditis, fever therapy for, 524
- Gonococcal infection, fever therapy for, 194  
heating for, 551
- Gonococcal meningitis, fever therapy for, 488
- Gonococcal urethritis, thermotherapy for, 551
- Gonorrhoea, fever therapy for, with sulfonamides, 551  
in women, Bierman treatment technique, 564-6  
sulfapyridine and fever therapy in, 194
- Gordon, R. G., 456
- Gout, baths for, brine, 38; cabinet, 20; hot sulfur, 84; leg and foot, 41; mustard foot, 41; radiant heat, 20  
eliminative douches for, 62  
hot mud packs for, 84  
mineral waters for, 84
- Graduated exercise, in tuberculosis, 425
- Greene, R., 534
- Grenz rays, 92
- Groag, P., 160
- Grodines, on electrical stimulation in muscle atrophy, 267
- Groedel, F., 524-5
- Grotthus' law, 96
- Gums, massage of, 536
- Gunshot injuries, whirlpool baths for, 45
- Gutzeit, K., 536-7
- Gymnasium, for paraplegics, 417
- Gynecological diseases, 560 ff.
- Haberlin, C., 74
- Hair, fluorescence of, with ultraviolet radiation, 294  
*See also* Hypertrichosis
- Hamstring stretching, 365
- Happich, C., 77
- Hardt, L. L., 546
- Harpuder, K., 230-1, 530
- Harrison, F. G., 526
- Harrison, T. R., 374-5
- Hart, D., 298, 466
- Hartung, E. F., 454, 458
- Harvey, H. D., 313
- Hauffe, A. G., 13, 42, 524
- Havlicek, Hans, 313
- Hay fever, air-conditioning for, 76  
desensitization by pollens and iontophoresis, 238  
from photo-allergy, 295  
zinc ions for, 238, 581-3
- Head sling for cervical arthritis, 454
- Headaches, cold compresses for, 26  
contrast baths for, 42  
from fibrositis, 459  
from low barometric pressure, 70  
from ultraviolet radiation, 316
- Healing, effect, of cold on, 26  
of sun rays on, 278-81
- Hearing, loss of, 423
- Hearing aids, 423-4
- Heart disease, bed rest in, 374  
classified, 518  
exercises for, 518-22  
Nauheim (CO<sub>2</sub>) baths for, 523  
occupational therapy for, 380  
Schott exercises for, 519  
tests during, 521-2  
ultraviolet radiation contraindicated, 316
- Heart failure, from bed rest, 373
- Heat, absorption of, by earth, 67  
before manipulation, 473  
before massage, 471, 473  
concentration of, from diathermy, 142-3  
conductive, effects of, 6, 8, 11  
dry, indications for, in denervated muscle, 491  
effects of, 15, 17  
indications for, 105, 474, 476-80, 524  
in paraplegia, 414  
local, 16-7  
loss, and climate, 67; and peripheral vascular constriction and dilatation, 11-2; and temperature, 2; by evaporation of sweat, 2  
moist, indications for, in denervated muscle, 491  
photothermal, *see* Radiant heat

Heat—(*Continued*)

- production of, and loss in body heat, 2 and metabolism, 18, from active exercise, 331
- radiant *see* Radiant heat
- sources of, 91 ff
- specific, of substances for conductive heating 22
- tropical, and typhoid inoculation, 69
- vasodilatation by, 3 11-2
- Heat exhaustion, treatment for, 193
- Heat radiation, and temperature, 91
  - artificial source of, 92 ff
  - as electromagnetic wave, 91
  - from earth, 67
- Heat stroke, from artificial fever, 193-4
  - from radiant heat, 107
  - treatment of, 34 193
- Heated air, for baths, 19-20
- Heated mud for arthritis, 447
- Heater, electric, 95-6
- Heating after nerve suture, 461, and absorption of radiation 96-8, and cooling compared, 8, and electric exercise, 267 and wave length, 165 artificial, 69
  - conductive, 19 active hyperemia from, 11 difficulty of 17, 19 effects of, 2, 29 factors modifying, 19 graded 25 of female pelvic organs, 7-8, penetration with, 536
  - convective, 19
  - conversive, 19, 25
  - effects of, diathermy and short wave compared, 143 different wave lengths, 146 high frequency current, 122-5, non penetrative, 32, on blood pressure, 98, on skin, 15-6, short wave current, 168 uniterminal technique, 160
  - indications for, 474-7, 541
  - means of by high frequency current, 123, by short wave current, 141, 146-7, 149 151, 164 by visible and infrared radiation 98-9 comparison of 170-1 in electrical circuits, 122-5 of artificial fever cabinets, 177-9 of genito-urinary organs, 552-3 on terminating exercise, 436 pelvic, 146-7
  - precautions, 26-7

Heating—(*Continued*)

- subcutaneous, 97
- Heating hoods, 21
  - thermostatically controlled, 102 accidents from, 438
- Heels, painful, treatment of, 465
- Helbing's sign, 359
- Heliotherapy, and climate, for treatment, 275
  - caution, need for, 278-9
  - glass windows for, 281
  - indications for, 280-1, 539, 546
  - osteogenic action of, 280
  - technique, 278-80
- Hellwig, A, 441
- Hemangioma, electrolysis for, 240
- Hematopoesis, affected by barometric pressure, 70
- Hematoporphyrin, 295
- Hemiplegia, calcium ions for, 486-7
  - causes of, 485
  - diathermy for, 486-7
  - exercises for, 486
  - galvanic current for, 486
  - immobilization for, 485
  - massage for, 329 485
  - phototherapy for, 486
  - sodium ions for, 237
  - voluntary movements for, 485
  - whirlpool baths for, 486
- Hemoglobin, effect, of massage on, 321
  - of ultraviolet radiation on, 290
- Hemoglobinemia, iron mineral waters for, 83
- Hemoptysis, diathermy contraindicated, 136
  - in tuberculosis, 71
- Hemorrhage, after electrocoagulation, 211
- Hemorrhoids, electrode clamp for, 208, 547
  - electrosurgery for, 217, 547
  - technique, 547
- Hemostasis, with cutting current, 213, 215
- Hemostatic action of electrodesiccation, 205
- Hepatic disorders mineral water for, 83
- Hernia inguinal exercises for, 372-3
- Herniation of fascial fat in fibrositis, 460
- Herpes simplex, causes of fever therapy, 193 ultraviolet radiation, 316
  - treatment of, 193

- Herpes zoster, converse heating for, 509  
galvanic current for, 509  
static brush discharge for, 509  
ultraviolet radiation for, 315, 509
- Herschel, Sir William, 92
- Hertzian waves, 92-3
- Heuer, G., 318
- Hibben, J. S., 432
- High frequency current, 109 ff.  
and Joules' law, 122  
burns from, 112  
circuit for, 109  
control of, 111-4  
effects of, 109, 124-5  
electrodes, clips for, 114-7  
factors influencing use of, 123-4  
foot switch for, 114  
for arthritis, 447-50  
frequency of, 109  
generator, 621-3  
production of, 109
- Hines, on electrical stimulation in muscle atrophy, 267
- Hip, exercises for, 401
- Hip joint, exercises for, 339-41  
short wave technique for, 449
- Hippocrates, 173-4
- Histamine, application of, 452  
by iontophoresis, 237; medication by, 235, 236-7  
pharmacodynamic action of, 289
- Histamine ions, indications for, 237, 452, 476
- Histidine, 290
- Hoffman, E., 297
- Holmquest, H. J., 157
- Hordeolum, moist heat for, 576
- Horder, Lord, 78
- Horton, B. T., 16
- Hot quartz mercury vapor lamps, 284-5  
cooling of, 285  
spectrum, 284  
use of, 284
- Hot springs, 173
- Hot Springs National Park, Arkansas, 88
- Hubbard tank in paraplegia, 414
- Human organism, adaptation to environment, 2
- Humidity, atmospheric, absolute, 68, body cooling interfered with, 68, in heated apartments, 75; in operating rooms, Humidity—(Continued)  
76; low effect on upper respiratory tract, 75; relative, 68  
of cabinet during fever therapy, 185-6
- Hutchinson's prurigo, 295
- Hydrastine, a photosensitizer, 296
- Hydroa estivale, 295
- Hydroa vacciniforme, 317
- Hydrochloric acid, gastric, increased by cold applications, 8
- Hydrogen sulfide gas, in mineral water, 79-80, 83
- Hydrotherapeutic reaction, 30
- Hydrotherapy, defined, 29  
indications for, 513, 515, 578, 608
- Hyperchlorhydria, mineral waters indicated, 82-3  
treatment for, 539
- Hyperemia, active, 11  
by short wave, 168  
cutaneous, 11  
from infrared radiation, 98  
of gastric mucosa, 540  
of skin, 99
- Hyperesthesia, massage contraindicated, 330
- Hypersensitivity, to cold, 16  
to drugs, 296-7  
to solar rays, 295
- Hypertension, and cold weather, 69  
arteriosclerotic, and spa therapy, 85  
autocondensation for, 135  
brine baths contraindicated, 38  
continuous baths contraindicated, 32  
functional, carbon dioxide baths for, 37, 85; massage for, 85, exercise for, 85  
ionized air for, 77  
oxygen baths for, 38  
phototherapy for, 106  
renal, carbon dioxide baths contraindicated, 523  
sensitivity to ultraviolet radiation, 294, 303  
test for, 13-4
- Hyperthermia, artificial, rectal temperature with, 4  
*See also* Fever therapy
- Hyperthyroidism, and ultraviolet radiation, 303; contraindications for, 316  
Turkish baths contraindicated, 20

- Hypertichosis electrocoagulation for, 218,  
611-2  
electrolysis for, 240-6
- Hypertrophic arthritis physical therapy  
for, 456
- Hypertrophied turbinates, electro-surgery  
for, 582  
zinc ions for, 583-4
- Hypotension, and tachycardia from bed  
rest 373  
carbon dioxide baths for, 523  
cold baths contraindicated, 31
- Hypotonic action of mineral waters, 80
- Hysterectomy by electro-surgery 217
- Hysteria, baths for, 31  
packs for, 48  
ultraviolet radiation for, 312
- Ice bag, indications for, 446, 524 560
- Imidazole acetaldehyde from histidine 290
- Immersion foot treatment of, 534
- Immobilization, indications for, 453 465,  
485  
of joints appliances for, 453
- Impetigo, iontophoresis for 238
- Incontinence, in paraplegia, 414
- Industrial convalescence, 429
- Infants and melanin formation, 294  
artificial hot water baths contraindi-  
cated, 30  
cold baths contraindicated, 34  
premature, air temperature for, 76
- Infarction cardiac carbon dioxide baths  
contraindicated, 523
- Infections, effect of ultraviolet radiation,  
298-9  
local diathermy for 135 phototherapy  
for, 105 short wave current for, 169  
of skin electro-surgery for, 216  
of upper respiratory tract pneumatic  
chambers for, 76  
postoperative and sterilization of air,  
298  
resistance to, 68-9
- Infectious diseases, ultraviolet lamps in  
disinfection for, 299
- Infiltrations over baths for, 21
- Inflammation abdominal hot leg and foot  
baths contraindicated, 41  
cardiac carbon dioxide baths contra-  
indicated, 523
- Inflammation—(Continued)  
chronic, cold compresses for, 48, 53  
diathermy contraindicated, 135  
massage contraindicated, 330  
mud baths contraindicated, 23  
passive movement contraindicated 334  
pelvic, acetylbetamethyl choline chloride  
ions for 566-9 hot leg and foot baths  
contraindicated 41 sitz baths for,  
45  
pulmonary, hot leg and foot baths con-  
traindicated, 41
- Inflammatory diseases, cold for, 26
- Infrared generators, 95-6
- Infrared heating units, 177-9
- Infrared radiation, 91-3  
and cataract, 107  
effects of 100, heating, 92 ff  
hyperemia from, 99  
in sun rays, 281  
leucocytosis from, 99-100  
long wave 170  
ocular injuries from, 575  
penetration of, 96-7  
phagocytosis from, 99  
place of in therapy, 96  
reaction of body to, 98-9  
sources of, 92, 94-6  
spectral limits of, 93
- Inguinal hernia, exercises for, 372-3
- Inhalation therapy, 76-7  
during fever therapy, 192  
indications for, 77  
mineral water spray, 81  
vaporized sulfur water for, 89
- Injuries, brine baths for, 84  
from radiant heat, 107  
from sun baths, 277  
mobilization after 338  
to soft tissues, treatment of, 460-2  
war to civilians 443
- Insomnia baths for, cabinet, 20 mustard  
41, neutral 31 oxygen 38 radiant  
heat, 20 tepid, 45  
douches for, 63  
in tuberculosis 71  
massage for, 513  
physical therapy for, 513  
relaxation exercises for, 513  
ultraviolet radiation for 312-3
- Intermittent venous occlusion, 530

- Interrupted direct current, *see* Galvanic current, interrupted  
 Intravenous occlusion, 530-1  
 Iodides, in ultraviolet therapy, contraindicated, 317  
 Ionization, 230-1  
 Ions, artificially produced, 77  
   atmospheric, 71-2, 77  
   in mineral waters, 79  
   medicinal, 230 ff.  
   rate of migration, 231  
 Iontophoresis, 230 ff.  
   advantages of, 230  
   batteries for, 232-3  
   current for, 230 ff.  
   dosage, 236  
   indications for, 236-9  
   novocaine, indications for, 237  
   reactions to, 232  
   solutions for, pH of, 232  
   technique, 232-6, for fingers, 452  
 Irradiation, antepartum, 309  
   of blood stream by ultraviolet radiation, 313-4  
 Irrigations, colonic, indications for, 455, 544; solutions for, 544; technique, 543-4  
   urethral, 561  
   use of, 65  
   vaginal, 561  
 Irritability of children, ultraviolet radiation for, 316-7  
 Ischemia, associated with pain, 11  
   of cutaneous area and viscus associated, 11  
   in paraplegia, 414  
   thermal sensitivity affected by, 433-4  
 Ischio-rectal abscess, electro-surgery for, 217  
 Isotonic action of mineral waters, 80  
 Itching, sponge baths for, 39  
 Izar, G., 150  
  
 Jacobson, E., 513  
 Jacoby, A., 566-7  
 Japanese, use of hot springs for therapy, 173  
 Jaundice, from fever therapy, 192-3  
 Jausion, H., 297  
 Jobs in vocational rehabilitation, 412  
 Joint immobilization, appliances for, 453-4  
   Joint immobilization—(*Continued*)  
     for atrophic arthritis, 453-4  
   Joints, exercise of, mechanical devices for, 331; stall bars for, 339  
     inflamed, continuous baths for, 32; mud baths for, 23  
     rheumatic, hot water baths for, 33  
     stiffened, paraffin baths for, 23  
   Jones, N. W., 13  
   Jostes, F. A., 471-2  
  
 Kaplan, I., 218  
 Karpovich, P. V., 374-5  
 Katelectrotonus effect, 224  
 Kellogg, J. H., 17, 56  
 Keloids, chlorine ions for, 610  
   electrosurgery inadvisable, 610  
   iodine ions for, 610  
   massage for, 610  
 Kenny method, conditions suitable for, 466-7  
   for knee joint injuries, 466-7  
   for poliomyelitis, 55-6; for reeducation after, 492-502  
 Keratitis, fever therapy for, 197  
   treatments for, 577  
   ultraviolet radiation for, 312  
 Keratoses, electrolysis for, 240  
   electrosurgery for, 609  
   from ultraviolet radiation, 295, 317  
 Kessler kineplastic arm, 418  
 Kidney, diseases of, cold douches contraindicated, 63  
   treatment, 106, 558-9  
 Kirschner wires for bone traction, 478  
 Knee joint, exercises for, 341, 397, 401, 466  
   injuries to, Kenny method for, 466-7; rest for, 466  
   short wave technique for, 465  
 Knott method for ultraviolet in septicemia, 314  
 Kowarschick, J., 151, 165-6, 538, 540  
 Kraurosis vulvae, electro-surgery for, 217  
 Kraus, H., 461  
 Krogh, A., 99  
 Kromayer lamp, 285, 308-9, 537  
   for ultraviolet irradiation of blood, 315  
 Krusen, F. H., 196-7  
 Kuchlin, W., 536-7  
 Kuhns, J. G., 398, 402

- Kuntz, A, 11, 13 16  
 Kusatsu Hot Springs, 173
- Lacerations, treatment of, 443
- Lachrymal duct, stricture of, electrolysis for, 579
- Lactic acid, and relief of pain, 16
- Lake, N C, 10
- Lamps, accidents from, 438  
 angulation, 101  
 carbon arc, *see* Carbon arc lamps  
 carbon filament, *see* Carbon filament lamps  
 erythemogenic power, 99 283 288, 291  
 illuminating, 241  
 incandescent, as source of visible and in-  
 frared radiation, 92-3  
 induction mercury vapor, 287-8  
 Kromayer, 285, 309-10  
 mercury vapor, *see* Cold quartz lamps  
 Hot quartz lamps, Mercury vapor  
 lamps, Tungsten filament lamps  
 precautions with 306  
 reflection for, 94 285  
 screening for, 101, 437-8  
 standardization of, 288  
 stands for, 95  
 sunburn from, 287
- Landis, E M, 13
- Landis-Gibbon test 12
- Landis technique for alternate positive  
 negative pressure, 530
- Lange M, 460
- Lapicque current 262
- Larsen, L A, 331
- Laryngeal tuberculosis electro-surgery for,  
 587  
 ultraviolet radiation for 587, local 590
- Laryngismus stridulus, ultraviolet radia-  
 tion for, 310
- Laryngitis, heating for, 590  
 inhalation for, 77  
 ultraviolet radiation for, 590
- Larynx, growths of, electro-surgery for 591  
 hysterical paralysis of, faradic shock for,  
 591
- Laurens, H, 97, 275 281-2, 290
- Lead poisoning, sulfur mineral water for,  
 83
- Leather work, in occupational therapy,  
 380-2
- Leduc current, 262
- Lens, crystalline, fluorescence of, with ul-  
 traviolet radiation, 294
- Lesions, superficial, electrode spacing for,  
 160
- Leucocytes, in artificial fever, 181
- Leucocytosis, augmented by heat, 100  
 from ultraviolet radiation, 300
- Leukemia, climate for, 73  
 ice packs for, 22
- Leukoplakia, electro-surgery for, 609
- Lewis, Sir Thomas, 15-6, 31, 99, 500
- Lichen ruber, aggravated by ultraviolet  
 radiation, 295
- Licht, S, 269
- Liebesny, P, 150, 262
- Light, A B, 16
- Light, hypersensitivity to, *see* Photo-allergy  
 sensitivity of eyes to, 107  
 spectrum, 93
- Light baths, *see* Baths, radiant heat
- Light therapy, *see* Phototherapy
- Lindsay, M K, 479
- Lines of force in short wave condenser  
 field, 143 152
- Ling, P, 331
- Lanke, F, 76
- Lip reading, 423-4
- Lithium ions for arthritis, 237
- Litmus test for polarity, 223, 412
- Little's disease 488
- Littre, glands of, electro-surgery for, 218
- Live wires, death from, 444
- Liver, diseases of short wave current for,  
 540, organic, spa therapy contraindi-  
 cated, 85  
 dysfunction mineral water for, 82  
 temperature of, 2
- Local anesthesia *see* Anesthesia, local
- Long wave, defined, 109
- Long wave diathermy, 109, advantages of,  
 109 physiology of, compared with  
 short wave, 143, use of in fever ther-  
 apy for gonorrhoea, 194
- Lordosis exercises for, 454  
 lumbar, breathing, exercises for, 356
- Lortat-Jacob applicator for dry ice ther-  
 apy, 608
- Lovett, R W, 336
- Low back pain adhesive strapping for,  
 470-1

- Low back pain—(*Continued*)  
 and posture, 360  
 brace for, 470  
 causes of, 360-2, 467, 470, 512  
 diathermy for, 467, 470  
 electric currents for, 467  
 exercises for, 362-71, 467-70  
 manipulation, 467, 470-3  
 massage, 467  
 phototherapy, 467  
 preheating, 471  
 rest, 467  
 short wave current for, 450, 467, 478  
 special couch for, 471  
 supporting belt for, 467, 470
- Lower extremities, exercises for, 340
- Lowman, C., 33
- Lucas-Championniere, J., 478
- Luckiesch, M., 317-8
- Ludwig, F., 99
- Lumbago, *see* Fibrositis
- Luminous irradiations, heating effect of,  
 170  
 in sun rays, 281
- Lung abscess, short wave for, 599-600  
 ultraviolet radiation for, 313, 600
- Lungs, blood supply, and barometric pres-  
 sure, 70  
 water loss from, at high altitudes, 70
- Lupus erythematosus discoides, from ultra-  
 violet radiation, 295  
 red light for, 106-7, 612-3  
 ultraviolet radiation contraindicated,  
 612-3
- Lupus vulgaris, carbon arc radiation for,  
 310  
 electrosurgery for, 218  
 ultraviolet radiation for, 612  
*See also* Tuberculosis, of skin
- Lymphangitis, arm and hand baths for, 41  
 massage contraindicated, 330, 531
- Lymphatic circulation, effect of massage  
 on, 322
- Lymphatic drainage, and thermal sensi-  
 tivity, 433
- Lymphogranuloma inguinale, fever ther-  
 apy for, 197
- Lymphoma, of orbit, radium plaques for,  
 577; x-ray for, 577  
 tuberculous, heliotherapy for, 281
- Machine tool operation in rehabilitation,  
 427
- MacKee, G. M., 240, 313, 317, 319, 606-7
- MacLeod, J. J. R., 10
- Magnesium ions, for multiple warts, 238  
 for muscle spasticity, 238
- Maize, photosensitizing effect, 296
- Malaise, from ultraviolet radiation, 316
- Malaria inoculation for fever therapy, 174
- Malarial fever and epilepsy, 174
- Malignancy, fever and x-ray therapy in  
 treatment of, 196-7  
 in albino rats from intense ultraviolet  
 radiation, 296
- Malignant cells, and ultra short waves, 150
- Malignant growths, diathermy contraindi-  
 cated, 136  
 electrosurgery for, 215-6
- Malnutrition, ultraviolet radiation for, 313
- Mania, neutral baths for, 31  
 tepid baths for, 513
- Manipulations, contraindicated, by acute  
 inflammation, 471  
 for feet, 464  
 for lower back, 471  
 for neck, 462  
 painful, ethyl chloride anesthesia for, 461  
*See also* Strains
- Marasmus, ultraviolet radiation for, 313
- Mask electrode, 115-6
- Mass reflex, in paraplegia, 415
- Massage, abdominal, 321, 329  
 after amputation, 480, 482  
 after dislocations, 327  
 after fractures, 328  
 after nerve suture, 491  
 as diagnostic aid, 320  
 as preventive of diabetic gangrene, 329  
 contraindications for, 328, 330, 455,  
 530-1  
 diuresis following, 321  
 duration of, 327  
 during pregnancy, 329  
 effects of, on acid-base balance, 321; on  
 edema, 322; on fat removal, 322; on  
 fractures, 478; on metabolism, 329; on  
 pain, 322; on urinary solids, 321; physi-  
 ological, 321-2; psychic, 322, 512; seda-  
 tive, 322  
 factors in, 321  
 for amputation stumps, 419

- Massage—(Continued)  
   for amputees, pommelling contraindicated, 419  
   indications for, 322, 327-30, 455, 460, 465, 471-3 485 488, 491, 512, 531-2, 536, 555, 579, 608  
   in muscular atrophy, 267  
   in paraplegia, 414  
   lubricants for, 327  
   methods of beating 324-6 compression, 324 friction, 324-5, hacking, 324 326, kneading 324, percussion, 324, 326 shaking, 326, slapping, 324-6, stroking, 323-4 tapping, 326, vibration, 323 326  
   physician's attitude to, 320-1  
   postpartum 329  
   technique, 323-7  
 Master, A M., 521  
 Mastoiditis, phototherapy for, 592  
 Maxwell, E C., 92  
 Mayer, E., 281, 311 596  
 McCurdy J H 331  
 Measles, ultraviolet for, 299  
 Mecholyf ions for circulatory disturbances of extremities, 452  
   for scleroderma, 238  
 Medical rehabilitation, 406-29  
 Medicinal ions, 237-8  
 Melancholia drip sheet bath for, 46-7  
   ultraviolet radiation for, 312  
 Melanin activated by ultraviolet radiation 294  
   and pigmentation, 294  
   as protection against ultraviolet radiation, 295  
   photosensitivity nullified, 295  
   production of, 294  
 Meleny, F L., 313  
 Meningitis fever therapy for, 488  
 Meningococcal meningitis, fever therapy for, 488  
 Mennell J B., 261, 329 336 338, 465  
 Menopausal arthritis, physical therapy for, 457  
 Menstruation cold contraindicated 41  
   diathermy contraindicated 136  
   hot leg and foot baths contraindicated, 41  
   sensitivity to ultraviolet radiation during 294, 303  
 Mental alienation, muscular, 466, 496  
   pseudo paralysis, 493  
 Mental capacity, and barometric pressure, 70  
 Mental derangement, neutral baths for, 31  
 Mentally disturbed patients, climate suitable for, 73  
 Mercury arc lamps, air cooled, 284-5  
   radiation from, 96 284-5  
   water cooled, 284-5  
 Mercury poisoning sulfur mineral water for, 83  
 Mercury sulfide by tattooing for pruritus ani, 548-9  
 Mercury vapor lamps, induction, 287, for official use, 287, operation of, 287, radiation from 287  
   quartz, distance from patient, 300-1, precautions with, 305-6  
   spectrum of 285  
   standards for, 288  
   types, 281, 284  
   *See also* Cold quartz lamps, Hot quartz lamps, Tungsten filament lamps  
 Merriman J R., 157  
 Metabolic diseases, climate for, 73  
 Metabolism, changes in, from ultraviolet radiation, 290 292-3  
   effects, of heating, 14-5, 98-9 of seasonal variations, 68 of temperature 14-5  
   stimulation of, cold baths for, 34  
   with active exercise 331-2  
 Metal work, in occupational therapy, 382-3  
 Metals, for electrode, 625  
   in short wave field, 165-6, 411  
 Meteorism, abdominal packs for, 56  
   sitz baths for, 45  
 Meter, high frequency current, scale on 113  
   not a guide for diathermy, 440  
 Methylene blue, photosensitization by, 296  
 Meyer, J 525 539  
 Micrococcus melitensis, effect of four meter wave on, 150  
 Milk, a carrier of vitamin D, 292  
 Mills C A 69 73  
 Mineral waters, administration of, 80  
   analysis of 79-80  
   artificial, value of, 79



Mineral waters—(*Continued*)

- baths, 81
- bottled, value of, 79
- classification, 79-80
- contraindicated, 86
- effects of, chemical, 79, 80-2; diuretic, 86; isotonic, hypertonic, and hypotonic, 80; mechanical, 80-2; physiological, 80-2; therapeutic, 79; thermal, 80-2
- elimination by, 80
- gaseous, 80, 87-9
- ingredients, 79-80
- medicinal uses, 81-2
- natural, 79
- neutral, 80
- saline, 79
- sulfur, 79-80, 86; laxative effects of, 182
- Mitchell's regime for neuroses and psychoses, 512
- Mobilization, after amputations, 482-3
  - after injuries, 338
  - early, during rehabilitation, 407
  - for atrophic arthritis, 453-4
- Mock, H. E., 383, 389, 466-7
- Molander, C. O., 404
- Moles, destruction of, by freezing, 610
  - electrolysis for, 240, 610
- Morale, sheltered workshop for, 428-9
- Moretti, P., 150
- Morgan's method of treating gastric atony, 538-42
- Morphine addiction, ice packs for, 22
- Morphine for pain, replaced, by cold air, 26
  - by ice, 22, 26
- Mortality rates for fever, 488
- Mortimer, B., 150
- Morton insole for metatarsal arch, 464
- Motor converter for direct current, 442
- Motor generator for direct current, 442
- Motor nerve injuries, electric tests for, 489
  - indications of, 265
  - physical therapy after, 489 ff.
- Motor points, charts, of face, 249, of foot, 256-7; of leg, 256-7; of thigh, 254-5, of torso, 252-3; of upper extremities, 250-1
  - displacement, 264
  - for electrical stimulation, 249-57
- Movement, active, 334
  - assistive, 334

Movement—(*Continued*)

- for sprains, 465
  - free, 334
  - passive, 334
  - relaxed, 334
  - resistive, 334
- Mt. Clemens Mineral Springs, Michigan, 88
- Mucous colitis, iontophoresis for, 238
  - massage for, 329
- Mud baths, *see* Baths, mud
- Mudd, S. G., 13, 69
- Muds, for bath, foreign proteins in, 23; special properties, 23
  - heated, for arthritis, 447
- Multiple sclerosis, fever therapy for, 488
- Mumps, ultraviolet for, 299, 315
- Muscle atrophy, galvanic current indicated for, 267, 491
- Muscle setting, 334
- Muscles, blood flow in, 332
  - contraction of, from faradic coil, 260-2
  - contused, massage for, 328
  - cramps, massage for, 328
  - dysfunction of, electric exercise for, 268
  - dystrophy of, physical therapy for, 515-6
  - electric exercise for, 269
  - inflamed, continuous baths for, 32; massage for, 328
  - mass movement of, 268
  - number of, 331
  - painful, mustard foot baths for, 41
  - paralyzed, stimulation of, 500
  - power of, effect of massage on, 322
  - reflexes of, from massage, 321
  - response of, after nerve injuries, 265-6
  - rheumatic, hot water baths for, 33
  - ruptured, cold contraindicated, 461
  - spasm of, hot water baths for, 33; Kraus' method, 461; massage for, 328
  - spastic, 105; magnesium ions for, 238; phototherapy for, 105
  - stiff, paraffin baths for, 23
  - stimulation of, 246-8, 260
  - strength of, 336
  - tension in, 331
  - testing, by interrupted direct current, 248, technique, 246-8, 260
- Muscular reeducation, for cerebral palsy, 488
  - in poliomyelitis, 499-500

- Muscular reeducation—(Continued)  
 indications for, 336  
 principles of, 336-8
- Musculo-spiral paralysis, treatment for, 443
- Mustard, with hot compresses 56
- Myalgia, histamine ions for, 237  
 of head, 459  
 saline iontophoresis for, 237  
*See also* Fibrositis
- Myelechreest, on fibrositis of back, 460
- Myocardial infarction recumbent position  
 contraindicated, 374
- Myofascitis, *see* Fibrositis
- Myogelosis, 460
- Myosin, changes in during muscular atrophy, 267
- Myositis, brine baths for, 38  
 cabinet baths for, 20  
 contrast douches for, 64  
 histamine ions for, 237  
 massage for, 328  
 phototherapy for, 105  
 radiant heat baths for, 20, 458  
 saline iontophoresis for, 237  
 static wave for, 271  
 steam douches for, 65  
*See also* Fibrositis
- Myositis ossificans, massage contraindicated, 459-60
- Nails, fluorescence of, with ultraviolet radiation 294
- Naphthol, a photosensitizer, 296
- Naphtholes photosensitivity nullified by, 297
- Narcotics, during fever therapy, 184-5  
 189-90
- Nasal congestion, 68
- Nasal furunculosis physical therapy for, 580
- Nasal mucous membrane and climate, 68  
 temperature of 13
- Nauheim bath technique, 35-8  
*See also* Baths carbon dioxide
- Neck injuries to, treatment of, 462
- Negative galvanism for contractures 175  
 for scars, 475
- Nephritis, massage contraindicated, 330  
 mineral water for 86  
 phototherapy for, 106
- Nephritis—(Continued)  
 thermotherapy for, 558  
 tuberculous, heliotherapy for, 558, ultra  
 violet radiation for, 558-9
- Nerve sectioned, and loss of thermal sensitivity, 433
- Nerve injuries, muscle response after, 262,  
 264-6  
 peripheral, Leduc current for, 262
- Nerve suture, exercise after, 489  
 hydrotherapy after, 489  
 passive motion after, 489  
 physical therapy after, 489  
 rate of nerve regeneration after, 491  
 splinting after, 489  
 thermotherapy after, 489
- Nervous disorders functional, ablutions  
 for, 46  
 cold half baths for, 39, 47  
 spa therapy for, 84-5
- Nervous exhaustion and climate, 69
- Nervous irritability, cold douches contraindicated, 63  
 neutral douches for, 63  
 oxygen baths for, 38
- Nervous system, and effleurage 322
- Neuralgia, aconite ions for, 237  
 cabinet baths for, 20-1  
 contrast douches for, 64  
 counterirritation for, 504  
 hot douches for, 63  
 massage for, 322  
 mud baths for, 23  
 phototherapy for 105  
 quinine ions for, 237  
 salicylic ions for, 237
- Neurasthenia fan douche for, 62  
 massage for, 329  
 sheet bath for 46  
 ultraviolet radiation for, 312
- Neuritis, ablutions for, 46  
 brachial 460 mud baths for, 23  
 cocaine ions for, 237  
 cold douches contraindicated 63  
 continuous galvanic current for, 229  
 converse heat for, 504  
 counterirritation for, 504  
 hot mud packs for, 84  
 hot sulfur baths for, 84  
 nupercaine ions for, 237  
 phototherapy for, 105

- Mineral waters—(*Continued*)  
 baths, 81  
 bottled, value of, 79  
 classification, 79-80  
 contraindicated, 86  
 effects of, chemical, 79, 80-2; diuretic, 86; isotonic, hypertonic, and hypotonic, 80; mechanical, 80-2; physiological, 80-2; therapeutic, 79; thermal, 80-2  
 elimination by, 80  
 gaseous, 80, 87-9  
 ingredients, 79-80  
 medicinal uses, 81-2  
 natural, 79  
 neutral, 80  
 saline, 79  
 sulfur, 79-80, 86; laxative effects of, 182  
 Mitchell's regime for neuroses and psychoses, 512  
 Mobilization, after amputations, 482-3  
 after injuries, 338  
 early, during rehabilitation, 407  
 for atrophic arthritis, 453-4  
 Mock, H. E., 383, 389, 466-7  
 Molander, C. O., 404  
 Moles, destruction of, by freezing, 610  
 electrolysis for, 240, 610  
 Morale, sheltered workshop for, 428-9  
 Moretti, P., 150  
 Morgan's method of treating gastric atony, 538-42  
 Morphine addiction, ice packs for, 22  
 Morphine for pain, replaced, by cold air, 26  
 by ice, 22, 26  
 Mortality rates for fever, 488  
 Mortimer, B., 150  
 Morton insole for metatarsal arch, 464  
 Motor converter for direct current, 442  
 Motor generator for direct current, 442  
 Motor nerve injuries, electric tests for, 489  
 indications of, 265  
 physical therapy after, 489 ff.  
 Motor points, charts, of face, 249; of foot, 256-7, of leg, 256-7; of thigh, 254-5; of torso, 252-3; of upper extremities, 250-1  
 displacement, 264  
 for electrical stimulation, 249-57  
 Movement, active, 334  
 assistive, 334  
 Movement—(*Continued*)  
 for sprains, 465  
 free, 334  
 passive, 334  
 relaxed, 334  
 resistive, 334  
 Mt. Clemens Mineral Springs, Michigan, 88  
 Mucous colitis, iontophoresis for, 238  
 massage for, 329  
 Mud baths, *see* Baths, mud  
 Mudd, S. G., 13, 69  
 Muds, for bath, foreign proteins in, 23; special properties, 23  
 heated, for arthritis, 447  
 Multiple sclerosis, fever therapy for, 488  
 Mumps, ultraviolet for, 299, 315  
 Muscle atrophy, galvanic current indicated for, 267, 491  
 Muscle setting, 334  
 Muscles, blood flow in, 332  
 contraction of, from faradic coil, 260-2  
 contused, massage for, 328  
 cramps, massage for, 328  
 dysfunction of, electric exercise for, 268  
 dystrophy of, physical therapy for, 515-6  
 electric exercise for, 269  
 inflamed, continuous baths for, 32; massage for, 328  
 mass movement of, 268  
 number of, 331  
 painful, mustard foot baths for, 41  
 paralyzed, stimulation of, 500  
 power of, effect of massage on, 322  
 reflexes of, from massage, 321  
 response of, after nerve injuries, 265-6  
 rheumatic, hot water baths for, 33  
 ruptured, cold contraindicated, 461  
 spasm of, hot water baths for, 33; Kraus' method, 461; massage for, 328  
 spastic, 105; magnesium ions for, 238; phototherapy for, 105  
 stiff, paraffin baths for, 23  
 stimulation of, 246-8, 260  
 strength of, 336  
 tension in, 331  
 testing, by interrupted direct current, 248; technique, 246-8, 260  
 Muscular reeducation, for cerebral palsy, 488  
 in poliomyelitis, 499-500

- Otitis externa—(Continued)  
 ultraviolet radiation for, 312-591
- Otitis media, chronic, conservative heat with  
 sulphonamides for, 592  
 photosensitizers for, 593  
 radiant heat for, 106, 315  
 ultraviolet for, 315  
 zinc ions for, 238
- Otorrhea chronic, Friel's formula for, 593  
 Friel's technique, 593-595  
 zinc ions for, 593-595
- Oudin terminal, for fulguration, 199-203  
 of high frequency circuit, 111
- Oxygen, capacity of blood, from massage,  
 321  
 in reducing temperature during fever  
 therapy, 187  
 in venous blood, from heat 16  
 need for, at high altitudes, 70
- Oxygen tension, in fever therapy, 187
- Oxygen tent air-conditioning in, 76
- Oxyhemoglobin, 16
- Packs hot abdominal 56, liver, 56  
 mud, 81  
 wet for psychoses, 515
- Pad electric, 170  
 for electrode spacing, 162
- Pain, and ischemia, 11  
 and overdosage with short wave, 440  
 cold for, 26  
 low back *see* Low back pain  
 massage, effect of, 322  
 muscular hot leg and foot baths for, 41  
 neuralgic hot douches for, 63  
 psychogenic, 512  
 relation of, to temperature rise, 513  
 sacro-iliac, corkscrew technique for,  
 472-3  
 substance causing, 16-7  
 visceral, alleviation by hyperemia 11  
 associated with ischemia, 11  
 whirlpool baths for, 43
- Pain receptors 11
- Palsy, cerebral, 488
- Pancake coil electrodes, 157, 159
- Panel board, for diathermy machine, 112,  
 114  
 for direct current 223  
 of short wave current apparatus, 144
- Papillomata, of eyelid, electrodesiccation  
 for, 204  
 of tongue, electrodesiccation for, 205  
 penile, electrodesiccation for, 557
- Paraffin, burns from, 437-8
- Paraffin baths, 22-3
- Parahormone, action of, 292  
 and excretion, of calcium, 292, of phos-  
 phorus, 292
- Paralysis, after intracranial tumors, 487  
 after poliomyelitis 492  
 after spinal cord lesions 488, 491  
 breathing exercise for, 501  
 electrical stimulation for, 267  
 of larynx, 591  
 peripheral, 490  
 slow sinusoidal current for, 268  
 spastic, 488
- Paralysis agitans, massage for, 329
- Paralytic ileus ultraviolet for, 315
- Paranasal sinusitis, phototherapy for, 105  
 zinc ions for, 238
- Paraplegia braces for, 415  
 calisthenics in, 414  
 chair training in, 416  
 in rehabilitation, 413  
 late treatment, 414-7  
 peristalsis in, 414  
 personal hygiene in, 417  
 rhizotomy in, 415  
 wheel chairs for, 415
- Paresis, general, fever therapy for, 194
- Passive exercise, Sanders rocking bed for,  
 498  
*See also* Exercise
- Passive fever, 174
- Passive hyperemia, for peripheral vascular  
 diseases, 530
- Passive motion for poliomyelitis, 500  
 for prevention of adhesions, 334
- Passive movement 334  
 for hemiplegia, 485  
 for prevention of atrophy, 334  
 indications for, 324
- Pathological changes from artificial fever,  
 182
- Patient, preparation of, for fever therapy,  
 183-4 for short wave treatment,  
 165-8  
 surroundings of, during physical therapy,  
 432

- Neuritis—(*Continued*)  
 vapor baths for, 87
- Neurodermatitis, cabinet baths for, 20  
 climate for, 614  
 fever therapy for, 196, 614  
 radiant heat baths for, 20, 614
- Neuroses, *see* Psychoses
- Neurosyphilis, fever therapy with chemotherapy, 488
- Neurovascular training, douches for, 61
- Neutral baths, *see* Baths, neutral
- Nevi destroyed, by electrolysis, 240, 609  
 by electrosurgery, 609  
 by freezing, 26, 609  
 by radium, 576, 609  
 by ultraviolet radiation, 609
- Nevus flammeus of eyelid, 576
- New growths, cutting current for, 215
- Newton, Sir Isaac, 92
- Nieden, A., 211
- Nitrogen, loss of, from bed rest, 373
- Nitrogen excretion, with massage, 321
- Non-pulmonary tuberculosis, *see* Tuberculosis, non-pulmonary
- Novocaine iontophoresis, indications for, 237
- Nupercaine iontophoresis for anesthesia, 237
- Nurseries, air-conditioning for, 76
- Nylin, J. B., 38, 519
- Ober, F., 470
- Obesity, brine baths for, 38  
 cabinet baths for, 21  
 cold baths for, 34  
 electrically induced contractions for, 273  
 massage for, 330  
 sulfate mineral waters for, 83, 86
- Obstipation, in paraplegia, 414
- Occupational therapy, aims, 377, 379, 404  
 and blindness, 422-3  
 at home, equipment for, 389  
 defined, 377  
 diversional occupation in, 380 ff.  
 exercises in, craft, 381-5, 387, 389 ff.;  
 hammering, 383; modeling, 380-1;  
 pedaling, 395, 397; planing, 394, sanding,  
 392-3; sawing, 391-2; weaving,  
 391-2, 395-6  
 for tuberculous bones and joints, 480  
 for visual impairment, 421-2
- Occupational therapy—(*Continued*)  
 functional, 428  
 games in, 395  
 indications for, 379 ff.  
 in tuberculosis, 426  
 nurse technician, duties of, 404  
 prescribing, 378, 386, 403  
 records of treatment by, 387  
 schools for, 378  
 with physical therapy, 383
- Oertel, M. J., 521
- Ohm's law, 221
- Oil of wintergreen, with hot compresses, 56
- O'Leary, on fever therapy and chemotherapy in syphilis, 195
- Oophoritis, acute gonococcal, diathermy contraindicated, 135
- Operating rooms, air-conditioning for, 76
- Oppenheimer, E. T., 521-2
- Optic nerve atrophy, syphilitic, fever therapy for, 579
- Oral infections, ultraviolet radiation for, 537
- Organic disease, artificial fever contraindicated, 27  
 artificial hot water baths contraindicated, 30
- Orificial electrodes, 119, 160, 162  
 channeled for thermometer, 121  
 fixation of, 119, 121-2  
 for pelvic heating, 146-7  
 shape of, 119
- Orificial tubes for ultraviolet radiation, 282
- Ornstein, O., 269
- Orthopedically handicapped, sheltered workshops for, 429
- Osborne, L., 141
- Osborne, S. L., 150, 157
- Osteo-arthritis, spa therapy for, 84  
*See also* Arthritis
- Osteochondritis, heliotherapy for, 280
- Osteomalacia, heliotherapy for, 280  
 ultraviolet radiation for, 309, 312
- Osteomyelitis, brine baths for, 38, 84  
 convulsive heat for, 480  
 heliotherapy for, 280  
 sulfonamides for, 480  
 ultraviolet radiation for, 312-3, 480
- Otitis externa, heat for, 106, 591  
 tin ions for, 591

- Otitis externa—(Continued)  
 ultraviolet radiation for, 312, 591
- Otitis media, chronic, convulsive heat with  
 sulphonamides for, 592  
 photosensitizers for, 593  
 radiant heat for, 106, 315  
 ultraviolet for, 315  
 zinc ions for, 238
- Otorrhea, chronic, Friel's formula for, 593  
 Friel's technique 593 595  
 zinc ions for, 593, 595
- Oudin terminal, for fulguration, 199-203  
 of high frequency circuit, 111
- Oxygen capacity of blood, from massage,  
 321  
 in reducing temperature during fever  
 therapy, 187  
 in venous blood from heat 16  
 need for, at high altitudes, 70
- Oxygen tension in fever therapy, 187
- Oxygen tent air conditioning in, 76
- Oxyhemoglobin, 16
- Packs hot, abdominal, 56 liver, 56  
 mud 81  
 wet for psychoses, 515
- Pad electric 170  
 for electrode spacing 162
- Pain, and ischemia, 11  
 and overdosage with short wave 440  
 cold for, 26  
 low back, *see* Low back pain  
 massage, effect of, 322  
 muscular, hot leg and foot baths for, 41  
 neuralgic, hot douches for, 63  
 psychogenic, 512  
 relation of, to temperature rise, 513  
 sacro-iliac, corkscrew technique for,  
 472-3  
 substance causing, 16-7  
 visceral, alleviation by hyperemia, 11  
 associated with ischemia, 11  
 whirlpool baths for, 43
- Pain receptors 11
- Palsy cerebral, 488
- Pancake coil electrodes 157, 159
- Panel board for diathermy machine, 112,  
 114  
 for direct current, 223  
 of short wave current apparatus, 144
- Papillomata, of eyelid, electrodesiccation  
 for, 204  
 of tongue, electrodesiccation for, 205  
 penile, electrodesiccation for, 557
- Paraffin, burns from, 437-8
- Paraffin baths, 22-3
- Parahormone, action of, 292  
 and excretion, of calcium, 292, of phos-  
 phorus, 292
- Paralysis, after intracranial tumors, 487  
 after poliomyelitis 492  
 after spinal cord lesions, 488, 491  
 breathing exercise for, 501  
 electrical stimulation for, 267  
 of larynx, 591  
 peripheral 490  
 slow sinusoidal current for, 268  
 spastic, 488
- Paralysis agitans, massage for, 329
- Paralytic ileus ultraviolet for, 315
- Paranasal sinusitis, phototherapy for, 105  
 zinc ions for, 238
- Paraplegia, braces for, 415  
 calisthenics in, 414  
 chair training in, 416  
 in rehabilitation, 413  
 late treatment, 414-7  
 peristalsis in, 414  
 personal hygiene in, 417  
 rhizotomy in, 415  
 wheel chairs for, 415
- Paresis, general, fever therapy for, 194
- Passive exercise, Sanders rocking bed for,  
 498  
*See also* Exercise
- Passive fever, 174
- Passive hyperemia, for peripheral vascular  
 diseases 530
- Passive motion, for poliomyelitis, 500  
 for prevention of adhesions, 334
- Passive movement 334  
 for hemiplegia 485  
 for prevention of atrophy, 334  
 indications for, 324
- Pathological changes from artificial fever,  
 182
- Patient, preparation of for fever therapy,  
 183-4, for short wave treatment,  
 165-8  
 surroundings of, during physical therapy,  
 432

- Pattison, H. A., 377  
 Paul, N. C., 295  
 Pelvic congestion, mustard foot baths for, 41  
 Pelvic heating, by vaginal bags, 561-2  
   electrode thermometer with, 147  
   short wave with orificial electrodes, 146  
   technique, 561-6  
   with fever therapy, 190, 191  
 Pelvic inflammations, acute, diathermy contraindicated, 136; acetylbetamethyl choline chloride ions for, 566-9  
   conductive heat for, 562  
   sitz baths for, 560  
   thermotherapy for, 560  
 Pelvic pain, abdominal ice bag for, 560  
   mustard foot baths for, 41  
 Pemberton, R., 321, 328  
 Penis, diathermy of, 121-2  
 Pennington, D., 456  
 Penyugal Hot Springs, 87  
 Perfumes, as sensitizers to ultraviolet radiation, 317  
 Periarthritis, traumatic, phototherapy for, 104-5  
 Pericarditis, chronic, carbon dioxide baths for, 523  
 Peripheral vascular diseases, acetylbetamethyl choline chloride ions for, 237, 452, 532  
   alternate air pressure for, 529-30  
   Buerger's exercises for, 527-9  
   cold for, 526  
   contrast baths for, 42  
   diagnosis of, 12  
   diathermy for, 526-7  
   foot baths contraindicated, 438  
   heat for, 495-7  
   heating hood for, 106  
   histamine ions for, 237; technique, 532  
   intermittent venous occlusion, 530-1  
   massage for, 531-2  
   mecholyll ions for, 237-8  
   passive exercise for, 527-9  
   radiant heat for, 525  
   venous compression, 530-1  
   warm baths for, 525  
   whirlpool baths for, 525  
 Peristalsis, in paraplegia, 414  
 Peritonitis, heliotherapy for, 280  
   treatment by irradiated blood, 315-6  
 Peritonitis—(Continued)  
   ultraviolet radiation for, 313, 315  
 Pernicious anemia, and climate, 69, 73  
 Personal hygiene, blindness and, 422-3  
   for paraplegics, 417  
 Petrissage, 324-5  
 Petrolatum, prophylaxis against sunburn, 317  
 Pflohm, E., 150  
 pH, and barometric pressure, 70  
   and temperature rise, 16  
   of solutions for iontophoresis, 232  
 Phagocytosis, and infrared radiation, 99  
 Pharyngitis, and nasal congestion, 68-9  
   inhalation therapy for, 77  
   streptococcus, ultraviolet for, 315  
   thermotherapy for, 585-7  
   ultraviolet radiation for, 587  
 Phelps, W. M., 488  
 Phenolphthalein test for polarity, 442  
 Philips, W. H., 174  
 Phlebitis, acute, treatment of, 533  
   diathermy, contraindicated, 136  
   histamine ions for, 237  
   massage contraindicated, 330  
 Phosphines, photosensitization by, 296  
 Phosphorus in blood serum, after ultraviolet radiation, 290  
 Phosphorus, loss of, from bed rest, 373  
 Photo-allergic diseases, 295-6  
 Photo-allergy, 295  
 Photodynamotherapy, indications for, 297  
 Photo-ophthalmia, 289, 575  
 Photosensitivity, conditions modifying, 297  
   drugs modifying, 296-7  
   nullified by darkness, 297  
   of psoriasis, 295  
 Photosensitization, by diet, 296  
   by drugs, 296-7  
   by dyes, 296  
   by ointments, 614  
   pharmaceutic, 296-7  
 Phototherapy, accidents from, 438  
   effect of, 104-6  
   indications for, 104-6, 429, 472  
   overdosage, 106  
   precautions with, 438  
   technique, 99, 100  
 Physical directors, schools for, 332  
 Physical examinations, 332  
 Physical fitness, 410; inactivity and, 410

- Physical therapy, accurate diagnosis a prerequisite, 445  
 action through autonomic centers, 11  
 dangers from, 432 ff  
 efficiency of, 11  
 for amputations, 418-9  
 in psychiatric institutions, 512-3  
 limitations of, 436  
 psychic effects of, 512-3  
 schools for, subjects taught, 430-1  
 with occupational therapy, 403
- Physician, relation of, to technician, 430-2  
 responsibility of, for accidents, 430
- Pigment, formation of, in skin, 1  
 photosensitivity nullified by, 297
- Pigmentation, from radiant heat, 99  
 relation to therapeutic response, 294
- Pincussen, L., 293
- Pinel, P., 377
- Pityriasis versicolor, fluorescence of, 294
- Plasma reduction anoxemia, 180
- Plaster cast electrode, 115-6, 126
- Plastic guards for condenser electrodes, 153-4
- Plate electrodes, application, technique for, 114-9  
 burns from, 114  
 fixation of, 119  
 for high frequency current, 114 ff  
 method of making, 115, 117-8  
 shape of 118  
 size of, 118
- Pleural adhesions electro-surgery for, 216
- Pleural effusions tuberculous, 71
- Pleuritic adhesions and altitude 75
- Pneumatic chambers, air-conditioning in, 76  
 for asthma, 76  
 for bronchitis, 76  
 for emphysema, 76
- Pneumonia, from bed rest, 373  
 lobar, diathermy for, 600
- Polarity, galvanic current, tests for, 442  
 inversion, with reaction of degeneration, 264  
 negative of direct current 221  
 of binding posts in panel board for direct current, 223  
 of static bath 271-2  
 of static current, 270-1  
 of static spark, 271-2
- Polarity—(Continued)  
 of static wave, 270-1  
 positive, of direct current, 222  
 tests for, bubble, 221-2, litmus, 223, rod, 270
- Pole, for epilation, 442
- Poliomyelitis, anterior, 492  
 breathing exercises for, 501  
 deformities caused by, 494-6  
 exercise in bed for, 500  
 functional tests after, 501  
 incoordination in, 494  
 Kenny concept of, 492 ff  
 nursing care for, 496-7  
 position of patient, 498-9  
 prostigmine and curare in, 502  
 saline iontophoresis for, 237  
 ultraviolet for, 315  
 walking exercises for, 500-1  
*See also* Kenny method
- Pollack, L. J., 489
- Pollenosis, *see* Hay fever
- Polyps, electro-surgery for, 205 216-7  
 pedunculated, electrodesiccation for, 205  
 rectal, electro-surgery for, 548
- Porphyrynia, 295
- Postoperative care, air-conditioning for, 76
- Postoperative infections and air sterilization, 298
- Postpartum exercises, 573
- Postpartum hemorrhage massage for, 329
- Postpartum pain, massage for 329
- Posture abdominal exercises for, 346 362-4  
 abdominal weakness effect of, 362  
 education for, 344 ff  
 exercises for, 344 ff  
 faulty, causes of, 356-8  
 good, 341 ff  
 normal deviations from 356-8  
 training in, 344 ff 454
- Posture sense, development of, 344 ff
- Potassium 71, 292, loss of, from bed rest, 373
- Pottenger F. M. 71, 73
- Poultices for localizing infections 105
- Pre-eclamptic toxemia ultraviolet radiation for, 313
- Pregnancy, diathermy contraindicated, 136  
 massage 330  
 sensitivity to ultraviolet radiation, 294, increased, 303



- Pregnancy—(*Continued*)  
 temperature test for, 6  
 ultraviolet radiation during, 309-10, 572
- Priessnitz bandage for colitis, 541
- Prostatic hypertrophy, electro-surgery for, 217  
 static wave for, 271
- Prostatitis, abscess, treatment of, 553  
 chronic, conversive heat for, 553-5  
 cold for, 553  
 gonococcal, diathermy for, 135  
 hypertrophy, electro-surgery for, 557  
 massage for, 555  
 sinusoidal current for, 555  
 sitz baths for, 44, 553  
 static wave for, 555
- Prosthesis for amputees, 418
- Prostigmine, in Kenny technique for poliomyelitis, 502
- Pruce, on use of blood plasma for fever therapy shock, 194
- Prurigo, Hutchinson's, from ultraviolet radiation, 295  
 sulfur baths for, 86  
 summer, from ultraviolet radiation, 317
- Pruritis ani, copper ions for, 235, 549  
 electro-surgery for, 217  
 iontophoresis for, 238  
 tattooing for, 549  
 ultraviolet radiation for, 549  
 zinc ions for, 549
- Pruritis vulvae, electro-surgery for, 217  
 iontophoresis for, 238
- Pseudo-paralysis, 494
- Psoriasis, and ultraviolet radiation, 607;  
 sensitization to, by coal tar, 614, value of, 614  
 cabinet baths for, 20  
 fluorescence of, 294  
 photosensitivity of, 295  
 radiant heat baths for, 20
- Psychasthenia, carbon dioxide baths for, 38  
 neutral baths for, 31  
 tepid baths for, 45
- Psychiatric patients in industrial therapy, 427
- Psychogenic anosmia, 512  
 Psychogenic aphonia, 512  
 Psychogenic blindness, 512  
 Psychogenic deafness, 512  
 Psychogenic pain, treatment of, 512-3
- Psychogenic retention of urine, 512
- Psychological adjustment during rehabilitation, 407
- Psychological management, criticism and praise and, 409  
 diversions in, 409  
 during rehabilitation, 407  
 friends and relatives and, 409  
 happiness of patient in, 409  
 home visits and, 409  
 in rehabilitation, 408-9  
 qualifications of personnel for, 408
- Psychological tests, *see* Vocational rehabilitation
- Psychometry, in reconditioning and rehabilitation, 427  
 in vocational rehabilitation, 413  
 psychographs in, 413
- Psychoses, continuous baths for, 32, 513  
 hydrotherapy for, 512-3  
 Mitchell's regime for, 512  
 phototherapy for, 106  
 spa therapy contraindicated, 84  
 static baths for, 273  
 wet packs for, 515
- Pterygium, electro-surgery for, 216
- Puerperal sepsis, treatment of, by irradiated blood, 315  
 ultraviolet for, 315
- Pulmonary collapse, resulting from bed rest, 373
- Pulmonary congestion, resulting from bed rest, 373-4
- Pulmonary tuberculosis, *see* Tuberculosis, pulmonary
- Pulmonary volume, increased by high altitudes, 70
- Pulse rate, during active exercise, 331-2  
 effects of heating on, 98  
 from passive exercise, 331-2  
 with artificial fever, 180
- Pus, confined, diathermy contraindicated, 135  
 evacuation of, before diathermy, 135; before phototherapy, 105  
 thermal sensitivity affected by, 433
- Pyelitis, chronic, mineral waters for, 86
- Pyloric stenosis, ultraviolet radiation for, 312
- Pylorospasm, conductive heat for, 538-9  
 intragastric faradization for, 538-9

- Pylorospasm—(Continued)  
   lavage for, 538-9  
   short wave current for, 538-9  
   ultraviolet radiation for, 312  
 Pyoderma, extensive, ultraviolet radiation  
   contraindicated, 295  
 Pyrocatechin photosensitivity nullified by,  
   297  
  
 Quadriceps, redevelopment of, after knee  
   injuries, 467  
 Quartz burners, 284-5  
 Quartz rods for quartz lamps, 285  
 Quincke's edema 296  
 Quinine, a photosensitizer, 296  
 Quinine ions, for trigeminal neuralgia, 505  
   iontophoresis with, 237  
 Quinine sulfate, fluorescence of, 294  
  
 Racks for electrode cables, 167  
 Radiant heat, contraindications for, 515  
   danger from, 107, 515  
   dosage, 99-100  
   from infrared generator, 95-6  
   generator for, specifications, 620-1  
   injurious effects from, 107  
   skin tolerance to, 97-8  
   sources of, 92 ff  
 Radiation, cosine law for, 301-2  
   effectiveness of 101, 301  
   inverse square law of, 101, 300-2  
   penetration of, 96-8  
   source of, in carbon arcs 282-4  
   sources of arc lamps, 96 carbon fila-  
   ment lamps 94 luminous 97  
   mercury vapor induction lamps, 287  
   reflector, 94 sun, 91  
   with Corex D filter, 283  
 Radio interference, by diathermy and short  
   wave 171  
   federal standards for diathermy and 171  
 Radio listening in aural disability, 424  
 Radioactive rays, 92  
 Radioactive springs 80  
 Radiodermatitis, conductive cold con-  
   traindicated, 27  
   electrolysis for, 240  
 Radium 93  
 Ragweed, desensitization to by pollen  
   iontophoresis 238-9  
  
 Ralli E P, 372  
 Rashes, from photosensitivity, 296-7  
   from ultraviolet radiation and sulfanila-  
   mide 296  
 Rathbone J L, 331, 513  
 Ray, M B 31, 56  
 Reaction cure 81  
   generalized to radiant heat, 98  
   of degeneration 262, 264-6  
   of patients during fever therapy, 184 ff  
   secondary to baths, 31  
   to cold baths, 30  
 Reconditioning and rehabilitation, 426  
 Rectal electrodes, 119  
   for short wave 162  
 Rectal temperature *see* Temperature rectal  
 Rectification, for direct current 223  
   of electric currents, 221  
 Red blondes and melanin, 294  
 Red cells after massage 321  
   and ultraviolet radiation, 292, 312  
 Red light, for lupus erythematosus, 106-7,  
   613  
   for smallpox, 106  
   photosensitivity nullified by, 297  
 Red mangel photosensitizing effect 296  
 Red rays, and growth 99  
 Reducing technique for, 61  
 Reduction of swelling, by massage 321  
 Reed C J, 96  
 Reeducation of paralyzed muscles 499-500  
 Reflection, of radiation from skin surface,  
   97  
   of ultraviolet radiation, 276  
 Reflectors 285  
 Reflex action 11-3  
 Refrigeration for carcinomatosis, 4 6 22  
   rectal temperature during, 4 6  
 Refrigeration anesthesia, for amputations,  
   490-3  
 Refrigeration machine, in anesthetization  
   for amputation 480  
 Regeneration after nerve suture, rate of,  
   491  
 Rehabilitation, abuse of rest during 407  
   ambulation in 415-7 418-20  
   and reconditioning 426-7  
   aphasia in 420-1  
   arano kineplastic arm, 418  
   aural disability in, 423  
   blindness in 422-3

- Rehabilitation—(*Continued*)  
 commencement during convalescence,  
 407  
 crutch walking in, 416-7  
 education of tuberculous patients in,  
 425-6  
 educational retraining in, 427  
 family physician and, 406  
 for amputees, 417-20  
 gymnasium for, 417  
 hearing aids in, 423  
 industrial therapy in, 427-8  
 learning to use appliances, 411  
 lip reading in, 424  
 loss of extremity in, 413  
 medical, 406-29; defined, 406  
 morale building in, 410  
 motion picture films for amputees, 418  
 physical fitness in, 408, 410  
 physical therapy in, 418-9  
 physician, role of, 410-1  
 psychographs in, 413  
 psychological adjustment, 407  
 psychoneurosis and, 407  
 sheltered workshop in, 428-9  
 shop retraining in, 427  
 treatment, 406 ff.  
 tuberculosis and, 424-6  
 visual impairment in, 421-3  
 vocational, 411-3; earning capacity and,  
 411-2
- Rehabilitation program, restoration of  
 functions, 407-8
- Reiter, T., 150
- Relaxation, exercises for, 513  
 methods of inducing, 353-6
- Renal calculi, from bed rest, 373
- Repair, accelerated by heat, 17  
 hindered by prolonged cooling, 27
- Resistance, of human tissue to high fre-  
 quency current, 122-5  
 to infections, increased by ultraviolet  
 radiation, 299-300
- Resorcin, photosensitivity nullified by,  
 297
- Respiratory diseases, spa therapy for, 85
- Respiratory infections, increase of, in  
 winter, 69  
 ultraviolet radiation for, 315
- Respiratory rate, during artificial fever, 183  
 with exercise, 331
- Respiratory volume, and high altitudes, 70
- Rest, a vasoconstrictor, 3  
 indications for, 465, 476-80, 534
- Restlessness, tepid baths for, 45
- Retina, electrocoagulation for detachment  
 of, 579
- Reynaud's disease, carbon dioxide baths  
 for, 523  
 histamine ions for, 237  
 mecholyl ions for, 237
- Rheobase, 260
- Rheophore, for high frequency current,  
 114
- Rheumatic conditions, cabinet baths for, 20  
 climate for, 73  
 cold douches contraindicated, 63  
 contrast douches for, 64  
 hot sulfur baths for, 84  
 ionized air for, 77
- Rheumatic endocarditis, change of climate  
 for, 524  
 fever therapy for, 524
- Rheumatic fever, exercise in, 374  
 fever therapy for, 196  
 ultraviolet for, 315
- Rheumatic infections, and climate changes,  
 71
- Rheumatism, eliminative douches for, 62  
 hot leg and foot baths for, 41  
 mud baths for, 23  
 subacute, ultraviolet radiation for, 313  
 vapor baths for, 87
- Rhinitis, and nasal congestion, 68-9  
 atrophic, 582  
 inhalation therapy for, 77
- Rhinophyma, electrosurgery for, 611
- Rhinosinusitis, acute, treatment for, 580-1
- Rhizotomy, in paraplegia, 415
- Rhythm, use of, in aphasia, 421
- Rich's reaction, 266
- Rickets, and vitamin D deficiency, 290-2  
 ultraviolet radiation for, 307, 309
- Ringworm, fluorescence of, 294
- Ritter, J., 91
- Robbins, F. W., 556
- Roche, M. B., 471-2
- Rod electrode for urethra, 121-2
- Rod test for polarity of static machine,  
 270-1
- Roffo, A. H., 296
- Rollier, A., 75, 275, 278, 280, 294

- Rosacea, electrolysis for, 240
- Rose and Solomon, on fever therapy and chemotherapy in syphilis, 195
- Rose bengal, photosensitization by, 296
- Rosenthal, C., 322
- Rotary converter, for diathermy machine, 111
- Ruhmann, W., 11
- Running, movements in, 359-60
- Rupture, of muscles, 461  
of tendons, 461
- Rush, Benjamin, 377
- Russian bath, *see* Air, heated
- Ryerson, E. W., 488
- Sacro-iliac belt, 472
- Sacro-iliac disease, corkscrew technique for pain, 472-3  
static spark for, 272
- Saidman, J., 275, 289, 294, 307, 538-9
- Salicylic ions for arthritis 237
- Saline iontophoresis, 237
- Salpingitis, acute gonococcal, diathermy indicated, 135  
electrosurgery for, 217
- Salt antiseptic effect of, 81  
for jaundice, 193  
intravenously, for heat exhaustion 193  
with fever therapy, 183, 185-6
- Sampson, H. L. 545
- Sanatoria for pulmonary tuberculosis, 597
- Sand bags to hold electrodes, 434
- Sanders rocking bed for peripheral vascular diseases, 528
- Saratoga Springs, New York, 88
- Sarcomas, from ultraviolet radiation, 296  
of orbit, electrocoagulation for 577
- Sayre head sling 507  
for traction, 462, 507
- Scalenus anticus syndrome 506
- Scar tissue chlorine ions for, 237  
massage for, 330  
paraffin baths for, 23-4
- Schenker A. W., 471 582
- Scheuermann's disease heliotherapy for, 280
- Schizophrenia refrigeration for 22
- Schliephake, E., 150 154
- Schnee bath 226  
for mass muscle movement 268
- Schools, for occupational therapy, 378
- Schools—(Continued)  
for physical directors, 332  
for physical therapy technicians, subjects taught at, 430-1
- Schott exercises for cardiac cases, 519-20
- Schwarzchild, M. M., 147
- Sciatica, baths for, brine, 38 cabinet, 20,  
hot immersion, 84 hot sulfur, 84,  
mud, 23 vapor, 87  
causes of, 508-9  
continuous galvanic current for, 229  
contrast douches for, 64  
from fibrositis, 460  
hot packs for, 84  
novocaine iontophoresis for, 237  
physical therapy for, 509
- Scleroderma acetylbetamethyl choline chloride ions for, 238  
cabinet baths for, 20  
galvanic baths for, 610
- Sclerosis disseminated, fever therapy for, 196  
massage for, 329
- Scoliosis, danger of after amputations, 419
- Scotch douche, *see* Douches, Scotch
- Scott's mercurochrome, 570
- Screens for lamps, 101-2
- Sea bathing, for non pulmonary tuberculosis, 74  
for tubercular bones and joints, 480
- Sea voyages, sedative and tonic effect of, 73-4
- Seabury, F. P., 556
- Seasonal variations, and metabolic activities, 69
- Sedative for fever therapy, 184-5
- Sedative effects, of infrared radiation, 99  
of massage 322
- Seminal vesiculitis, gonococcal, diathermy for 135
- Sensitivity, of eyes to light, 107  
of skin to ultraviolet radiation, 317  
thermal, affected by extravasated blood, 433  
to ultraviolet radiation 293-4
- Sensitizers to increase effects of ultraviolet radiation, 297
- Shades, eye, 101-2, 107  
for insomnia, 513
- Sheltered workshops, Altro Work Shops, 429

- Sheltered workshops—(Continued)  
 for blind, 429  
 for orthopedically handicapped, 429  
 for tuberculous patients, 429  
 garment manufacture in, 429  
 industrial convalescence in, 429  
 in rehabilitation, 428-9  
 morale in, 428-9
- Shimberg, M., 387
- Shock, cold contraindicated, 534  
 electric, causes of, 443-4; first aid for, 444; therapeutic, for psychoses, 513-5  
 from bombs, brine baths for, 443  
 heat harmful in, 534  
 treatment of, 534; in fever therapy, 194  
 venous pressure in, elevated by faradic current, 269
- Shop retraining, in rehabilitation, 427
- Short wave, defined, 109  
 specifications for, 526-7
- Short wave arcing, as cause of burns, 441
- Short wave circuit, construction of, 139-40
- Short wave current, 138 ff.  
 analgesic action of, 164  
 coagulating power of, 170  
 compared with diathermy, 143  
 heating, 140 ff., 171, point heating, 150-1; selective, 141  
 hyperemia from, 168  
 production of, 138 ff.
- Short wave current treatment, contra-indications, 170-1  
 control of, 144-5  
 dosage, 164, 440-1  
 effects of, 150-1  
 indications for, 168-70, 476, 588-9, 593  
 non-thermal effects, 150  
 overdosage, pain from, 410  
 technique, 138 ff., 151-5, 165-8, 422, 447-52; coplanar, 155-6, 449, 451, uniterminal, 160  
 time switch for, 167
- Short wave diathermy, 109  
 compared with long wave, 141
- Shoulder joint, exercises for, 339
- Shoulder ladder, for joint exercises, 339
- Shoulder wheel, for joint exercises, 339
- Shoulders, H S, 196, 198
- Shower bath, 61
- Sigma, 260
- Silver, a photosensitizer, 296
- Silver ions, for fungus diseases, 237-8
- Simmons, E. E., 196
- Simpson, W. M., 195
- Singer, C., 72
- Sinusitis, chronic, climate for, 72  
 short wave current for, 584-6  
 zinc ions for, 238, 585
- Sinusoidal current, 262-3  
 alternation rate, 262  
 for trigeminal neuralgia, 505  
 indications for, 262  
 slow, for treatment of paralysis, 268
- Skenes glands, inflammation of, electro-surgery for, 572
- Skin, and artificial fever, reaction with, 179; temperature with, 179  
 and atmospheric forces, 68  
 atrophy of, conductive cold contraindicated, 27; from ultraviolet radiation, 316-7  
 blemishes of, freezing mixture for, 26  
 blood vessels of, 1  
 cells of, 1  
 cooling power of, 98-9  
 flabby, massage for, 329-30  
 fluorescence of, with ultraviolet radiation, 294-5  
 infections of, electrosurgery for, 216; massage contraindicated, 330  
 inflammation of, brine baths contraindicated, 38  
 irritation of, chemical effects of, 16-7  
 lesions of, cold for destruction of, 608  
 metabolic responses in, 1  
 photosensitizers of, 295-7  
 preparation of, for galvanic treatment, 227  
 radiation reflected from, 97  
 reacting capacity of, to antigen, 1  
 sensation of cold and heat in, 28  
 temperature of, after typhoid inoculation, 179; depressed by mental states, 482; gradient of, 97-8; massage, effect on, 321-2; variations, 2  
 thickness of, 97-8  
 tolerance of, increased by ultraviolet radiation, 192; to fever therapy, 192; to radiant heat, 99; to ultraviolet radiation, 294  
 vasoconstriction of, 68

- Skin—(Continued)  
 vasodilatation of, 68 from galvanic current, 224
- Skin anesthesia, in paraplegia, 413-4
- Skin diseases and fever therapy, 196, sedatives contraindicated during 191 and ultraviolet radiation, 295-6, 607
- baths for, 608
- cold quartz mercury vapor lamps for, 285
- continuous baths for, 32
- freezing for, 608
- fungous, iontophoresis for 237-8
- hydrotherapy for, 608
- massage for, 608
- physical measures for, 606 ff
- Sky shine, 275
- Slagle, E. C., 404
- Sleeping bags, 176
- Sling for spinal traction, 462, 507
- Smallpox, red light for, 106
- Smart, M., 261, 465
- Smart Bristow faradic coil, 261
- Smith, E. E., 79
- Solar energy, 281
- Solar radiation, percentage of ultraviolet radiation in, 91, 275
- Soldman's device for concentrating 275
- Solaria special glass for, 281, 289
- Spa therapy, animals treated by, 78
- cases suitable for, 78
- clinical effects of, 81
- contraindications for, 85-6
- effects of due to mineral waters, 80-2
- not psychic, 78
- indications for, 83-9, 455-6, 522, 524 539
- Spacing electrode, materials for 160, 162-3
- Spacing for short wave electrodes, 160
- Spark gaps, 109-13
- Spas advantages of 522
- American 86-9 location of 79-80
- mineral waters of, 79-80
- need for, 86
- regime at 78
- selection of, for treatment, 78
- therapeutic care at, 83-6
- Spasmophilia, 292
- ultraviolet radiation for, 310
- Spasms, of esophagus dietotherapy for, 537-8 electric dilatation for, 538
- of pylorus, 638-9
- Spasms—(Continued)
- of sphincter ani diathermy for, 541
- rectal, diathermy for, 541, static wave for, 271
- shoulder, chronic, novocaine iontophoresis for, 237
- Spastic paralysis, 488
- Specifications for mercury vapor lamps, 287-9
- Spectrum, electromagnetic, 92-3
- natural and artificial compared 291
- of arc lamps 282-3
- of hot quartz mercury vapor lamps, 285
- Speech aids, 423
- Sphincter ani spasm of diathermy for, 541
- Spinal cord lesions 488
- Spinal drainage for convulsions 193
- Splanchno-peripheral interactions, 13
- Sprains arm and hand baths for, 41
- cold for, 465
- diathermy for, 465
- electric exercise for 465
- histamine ions for, 237
- hot leg and foot baths for, 41
- iontophoresis novocaine for, 237
- massage for, 327 465
- mud baths for, 23
- phototherapy for, 104-5
- saline iontophoresis for, 237
- static wave for, 271
- treatment of, 461, 465
- Springs, gaseous, 80
- mineral 79-80
- radioactive 80
- thermal 80
- Spurling R. G., 491, 517
- Squint, exercises for, 579
- Sribyatta, L., 16
- Stall bars for joint exercises 334
- Standard S., 372
- Starr, I., 528
- Stasis, 477
- Static bath, for psychic conditions 273
- polarity for, 273
- technique, 273
- Static brush discharge indications for, 106 272 457, 503, 509
- technique 272
- Static current, induced, 272-3
- polarity of, 272-3
- Static machine, 270-1

- Static spark, indications for, 272  
 polarity of, 272  
 technique, 271-2
- Static wave, indications for, 271, 572  
 polarity of, 270  
 technique, 270-2
- Steel anode, cause of tattooing in epilation, 442
- Sterility, electrosurgery for, 217
- Sterilization, of air, 298  
 of swimming pools, 299
- Stimulative procedures for the psychically depressed, 514-5
- Stokes, Sir William, 521
- Stomach, peristalsis of, 8  
 thermal changes in, 8
- Strains, hot leg and foot baths for, 41  
 lumbosacral, manipulation for, 471-3;  
 massage for, 327  
 sacro-iliac, manipulation for, 471-3;  
 massage for, 327
- Strandberg, O., 310
- Stretch reflex, 331
- Stroud, W. D., 520
- Stryker frame, in exercise for paraplegia, 415
- Subinvolution, uterine, cold for, 45  
 sitz baths for, 45
- Suicide, and barometric pressure, 70
- Sulfanilamide, a photosensitizer, 296
- Sulfapyridine, in fever therapy, 194
- Sulfonal, a photosensitizer, 296
- Sulfonamides, for osteomyelitis, 480  
 in ultraviolet therapy, contraindicated, 317
- Sulfur, antiseptic effect of, 81
- Sun, radiation from, 91 ff.
- Sun baths, 275 ff.  
 injurious effects of, 276-7
- Sunburn, effect of, 277; dangerous, 289 ff.  
 erythema from, 303  
 factors modifying, 278  
 from mercury vapor tungsten filament lamp, 287  
 from ultraviolet radiation, 316  
 pharmacodynamic action of, 289  
 prophylaxis against, 317  
 protection against, 303, 305, 317  
 reaction to, 303  
 symptoms of, 289
- Sunshine, physiological effects of, 71
- Surface irritation, systemic changes from, 99
- Surgery, and temperature, 69  
 thoracic, in tuberculosis, 425  
 ultraviolet radiation in, 313
- Surgical diathermy, application of, 199
- Surgical galvanism, 239 ff.
- Sweating, by phototherapy, 106  
 from blanket bath, 56  
 heat loss by, 2  
 loss by, in artificial fever, 181-2  
*See also* Elimination
- Swenson, E. A., 322
- Swimming pools, sterilization of, 299
- Swing through technique in crutch walking, 416
- Sydenham's chorea, fever therapy for, 196, 488
- Sympathin, 16
- Symptoms from high altitudes, 70-1, 74-5
- Synovitis, histamine ions for, 237  
 oven baths for, 21  
 phototherapy for, 104-5  
 saline iontophoresis for, 237  
 static wave for, 271
- Syphilis, chemotherapy and fever therapy, use of, in, 194-5  
 one-day cure for, 195
- Syringomyelia, and thermal sensitivity, 433  
 massage for, 329
- Tabes dorsalis, exercises for, 509-12  
 fever therapy with chemotherapy for, 509
- Tachycardia, carbon dioxide baths for, 523  
 cold compress for, 53  
 during fever therapy, 192  
 ice bag for, 524  
 intravenous glucose for, 192
- Tanks, therapeutic, 32-3
- Tannic acid, photosensitivity nullified by, 297
- Tanning, 294
- Tapotement, 324, 326
- Tarsalgia, heliotherapy for, 280
- Taylor, N. B., 10, 331-2
- Technicians, relation of, to physicians, 430-2  
 schools for, 430-1
- Teeth, fluorescence of, with ultraviolet radiation, 294

- Telangiectases, electrolysis for, 609  
 freezing for, 26
- Temperature, after exercise, 4  
 after meal, 4  
 change, effect on vasodilator substances,  
 15, from ganglionectomy, 10, in leg,  
 5-7, in pelvic organs, 7-8, in posterior  
 urethra, 7-8, 148, in thigh, 145  
 control of, in heating hoods, 102, in  
 ternal, 2  
 critical, and vasomotor paralysis, 10  
 environmental, for change in meta-  
 bolic rate, 14-5 for frostbite, 10  
 danger point, 192  
 determination, during fever therapy,  
 188-9, in excised tissue, 145, in living  
 human tissue, 145-6  
 effective, 67  
 extremity and external, volume of, 13  
 in long wave and short wave diathermy,  
 142  
 in nasal mucosa, and body chilling, 12-3  
 influence of, conflicting, 15, on cardio-  
 vascular system, 524  
 normal, 2  
 of air, factors affecting, 67-8, for pre-  
 mature infants, 76  
 of baths, 29 ff  
 of body surface, 31  
 of douches, 56  
 of extremities in cold environment, 2  
 of metals and radiation, 91  
 of muscle during pain 513  
 of operating rooms, 76  
 of skin, and environment, 2, and in-  
 sulation, 17, 19, and tolerance to  
 radiant heat, 98, during pain, 513  
 oral test for pregnancy, 6  
 pelvic, 146-7 148  
 positive electrode, carbon arc lamps, 282  
 rectal 2, after severe exertion, 4, during  
 artificial hyperthermia 4 during re-  
 frigeration, 4-5 fall of, 4, 6 from  
 radiant heat, 98  
 response of, to bacterial invasion, 4  
 rise, 19  
 sense, a guide to dosage 164  
 systemic, during fever therapy, 190-1  
 testing 164  
 tolerance limits of, 4 6, 562, of tissues  
 of body, 551
- Temperature—(Continued)  
 ultraviolet radiation, 91  
 urethral, 551-3  
 variation, effect of, on reaction, 29
- Temperature gradient of skin, and radiant  
 heat 98  
 in artificial fever, 180
- Tendons, fluorescence with ultraviolet  
 radiation, 294
- Tenesmus sitz baths for, 45
- Tenosynovitis, causes of, 473-4  
 electric exercise for, 474  
 heating for, 474  
 histamine ions for, 237  
 massage for, 327, 474  
 oven baths for, 21  
 phototherapy for, 104-5  
 physical therapy for, 474  
 saline iontophoresis for, 237
- Terrain cure for cardiac patients, 521
- Tesla terminal, 199
- Tests, electrical, for muscular reaction,  
 246-8, 258-60  
 for apical infection, 536-7  
 for cardiac cases, 521-2  
 for pollens, by iontophoresis, 238-9  
 for reaction of degeneration 262 264-6  
 for skin tolerance to radiant heat, 98  
 functional, after poliomyelitis, 501
- Tetany, and vitamin D deficiency, 292  
 infantile, ultraviolet radiation for, 306-7
- Therapy occupational, *see* Occupational  
 therapy
- Thermal gradient, of tissues, 10
- Thermal radiation, precautions for, 101-2
- Thermal sensitivity, factors affecting 433
- Thermal springs 80, 84
- Thermal stability of body, 11
- Thermal stimulation, benefits of, 11
- Thermal tolerance, variations in, 437
- Thermal treatments, accidents from,  
 436 ff, precautions, 101-2
- Thermometers, for diathermy electrodes,  
 120-1  
 for vaginal electrodes, 148
- Thermostats for heating hoods, 102  
 for hot water bags, 25
- Thomas collar, 462 507
- Thomas splint, 478
- Thomason's disease response in, to electri-  
 cal stimulation 266



- Thoracic surgery, deformity, permanent,  
from, 425  
in tuberculosis, 425
- Thorocoplasty, 425
- Thrombo-angiitis obliterans, and thermal  
sensitivity, 433  
exercises for, 527  
histamine ions for, 237  
mecholyll ions for, 237
- Thrombophlebitis, acetylbetamethyl cho-  
line chloride ions for, 532  
carbon dioxide baths for, 523  
postoperative, prevention of, 532-3  
ultraviolet for, 315
- Thrombosis, carbon dioxide baths con-  
traindicated, 523  
massage contraindicated, 330
- Thunderstorms and electric apparatus,  
435-6
- Thyroxin, 292
- Tice, F., 522
- Tinea, iontophoresis for, 238
- Tissues, fluorescent colors of, 294  
soft, trauma of, cold for, 460-1  
water content of, 70
- Tolerance of skin, to air temperatures, 7  
to heat, 98  
to ultraviolet radiation after tanning,  
294  
to water temperatures, 55
- Toleration limits to temperature variation,  
6
- Tomberg, V., 160
- Tonsillectomy, 587-90  
by electrocoagulation, 587-90
- Tonsillitis, inhalation therapy for, 77  
physical therapy for, 587
- Torticollis, causes of, 460  
massage for, 328
- Toxemia, cabinet baths for, 21  
pre-eclamptic, ultraviolet radiation for,  
313  
sterilization of blood for, by ultraviolet  
radiation, 313-6
- Toxic goiter, climate for, 69, 73  
electrosurgery for, 216
- Toxic reactions from ultraviolet radiation,  
289
- Tracheitis, inhalation therapy for, 77
- Trachoma, ultraviolet radiation for, 312
- Traction, by suspension, 506-8
- Traction—(Continued)  
for contractures, 475  
for fractures, 478  
manual, 462-3  
mechanical, 462
- Training, for aphasics, 421  
in-service, in rehabilitation, 413
- Transillumination of paranasal sinuses,  
96
- Transparency to ultraviolet radiation, of  
quartz, 284  
of other substances, 289
- Trapeze exercise, in paraplegia, 415
- Traumata, massage for, 328
- Traumatic arthritis, physical therapy for,  
457
- Traumatic injuries to soft tissues, 460-2
- Traumatic swelling, static brush discharge  
for, 272
- Travell's corkscrew technique for sacro-  
iliac pain, 472-3
- Treatment, automatic timer for, 435  
timing of, 300, 434-5
- Trichiasis, electrocoagulation for, 576
- Trichinosis, massage contraindicated, 459
- Trigeminal neuralgia, aconite ions for,  
237, 505  
conversive heating for, 505  
galvanic current for, 505  
quinine ions for, 237, 505  
salicylic ions for, 237  
sinusoidal current for, 504
- Triple response, 15-6
- Trypoflavine, a photosensitizer, 296
- Tuberculosis, active, sensitivity to ultra-  
violet radiation, 294, 303  
and altitude, 596  
carbon arc radiation for, 596  
correspondence courses for patients of,  
426  
education of patients in, 425-6  
intestinal, ultraviolet radiation for, 545-6  
metastatic spread of, 71  
non-pulmonary, heliotherapy for, 75,  
280-1; photodynamic therapy for, 297;  
physical therapy for, 480; sea bathing  
for, 74; ultraviolet radiation for, 306,  
310  
occupational therapy in, 426  
of bones and joints, heliotherapy for,  
280, orthopedic measures for, 480

- Tuberculosis—(Continued)
- of larynx, 590-1
  - of skin, electro-surgery for, 612-3, photo-dynamic therapy for, 287, ultraviolet radiation for, 612-3
  - pulmonary, altitude for, 75 carbon arc radiation for, 311, classification, 597, exercises for, 597-9, heliotherapy for, 281 physical therapy for, 598-9, sanatorium care, 597-8, seasonal exacerbations in, 71, sponge baths for, 38, surgical, 280-1, ultraviolet radiation contraindicated, 311, 316
  - rehabilitation 424-6
  - therapy, with calcium, 546
  - thoracic surgery in, 425
  - vocational guidance in, 426
  - walking for, 425
- Tuberculous arthritis, physical therapy for, 457
- Tuberculous choroiditis, heliotherapy for, 578
- Tuberculous iritis x ray for 577-8
- Tuberculous lesions ultraviolet radiation contraindicated 316
- Tuberculous lymphoma heliotherapy for, 280-1
- Tuberculous patients rehabilitation of, by occupational therapy, 379 sheltered workshops for 429 walking exercises for, 599
- Tuberculous peritonitis, heliotherapy for, 546
- Tuberculous sinuses ultraviolet radiation for, 480
- Tuke W, 377
- Tumors, benign electro-surgery for, 216-7 intracranial postoperative, physical therapy for, 487 malignant, electro-surgery for, 215-6
- Tungsten arc lamp 282
- Tungsten filament lamps, 287-9
- apparatus 95
  - disadvantages of, 100
  - radiation from 20
  - transformers for 287
- Turkish bath *see* Air, heated
- Turpentine stupe, 56-60
- Typhoid inoculation tropical heat and, 69
- Tyrosine 294
- Ulcers, alternating air pressure for, 529-30
- continuous baths for 31
  - decubitus, physical therapy for, 486 prevention of, 486
  - from galvanic electrode, 569
  - from ultraviolet radiation, in rodent 296
  - indolent, compression bandages for, 533 phototherapy for, 106, steam douche for, 533, ultraviolet radiation for, 312, 533 whirlpool baths for 533 zinc ions for, 238
  - intermittent venous occlusion for, 530-1
  - massage contraindicated, 330
  - of bladder, electro-surgery for, 217
  - of conjunctiva phototherapy for, 577
  - of cornea, electro-surgery for, 216 fever therapy for, 197 massage for, 579, phototherapy for, 577 zinc ions for, 238, 579
  - of leg acetylbetamethyl choline chloride ions for, 532
  - peptic, hot epigastric compress for 540
  - varicose, steam douches for, 65, ultraviolet radiation for 313
- Ultraviolet, indications for, 299
- lamps in disinfection 299
- Ultraviolet irradiation, in carbuncles, 315
- in pelvic inflammation 315
  - in peritonitis, 315
  - in puerperal sepsis 315
  - in septicemia, 315
  - of no value in neoplasms leukemia, psoriasis, Hodgkins, endocarditis, and syphilis 315
  - photosensitization in, 315
- Ultraviolet radiation a vasodilator, 3
- accidents with, 436-7
  - activation by, 300
  - and climate, 275 ff
  - antirachitic efficiency of, 287
  - as routine in surgery 313
  - automatic timing switch for, 300
  - biological responses to 289 ff
  - Birch Hirschfeld lamp, 576
  - conditions sensitizing to, 293-4
  - contraindications for, 316-7 in skin diseases 296
  - diseases from in rats, 296
  - dosage 300, 302-4 315
  - effects chemical 91, germicidal 297-

- Ultraviolet radiation—(*Continued*)  
 effects—(*Continued*)  
 300; lethal, 297-300; metabolic, 290-3;  
 on blood sugar, 293; on cholesterol,  
 293; on enzymes, 299-300; on fer-  
 ments, 299-300; on histidine, 290; on  
 red cells, 312; on toxins, 298, physio-  
 logical, 289; tanning, 294; on viruses,  
 298  
 erythema produced by, 293-4  
 fluorescence from, 294-5  
 for prophylaxis, 312  
 for raising skin tolerance, 192  
 for sterilizing, 297-300, 313-6  
 indications for, 275, 309 ff., 480, 508, 537,  
 539, 545-6, 549, 604, 606-7, 614-6  
 irradiation of blood stream by, 313-6  
 of eye, 576; injury to, 575  
 of lactating animals, 292  
 protection from, 305-7, 317  
 sensitivity to, of blondes, 293; of eyes,  
 296  
 sources, arc lamps, 282-4; atmosphere,  
 275; sun, 91, 295; variations in dif-  
 ferent, 300  
 spectral limits of, 92-3  
 spectrum, 91; of artificial and natural  
 sources, 291  
 substances transparent to, 289  
 technique, 300 ff.  
 temperature for production of, 91  
 toxic reactions from, 289  
 transmission, by Corning glass filter,  
 295; by human tissue, 291  
 treatment, 308; duration and frequency  
 of, 308
- Underwater exercise, 32-3  
 pools for, 32-3
- Ungley, C. C., 534
- Uranium salts, fluorescence of, 295
- Urethral caruncle, electro-surgery for, 572
- Urethral fistula, short wave current for,  
 556
- Urethral irrigations, technique, 561
- Urethral lesions, electro-surgery for, 557
- Urethral obstruction, electro-surgery for,  
 557-8
- Urethral polyps, electro-surgery for, 572
- Urethral strictures, electrolysis for, 555-6
- Urethral temperature, 7-8
- Urethritis, gonococcal, thermotherapy for,  
 551-3
- Urinary calculi, alkaline mineral water for,  
 82
- Urinary incontinence, electric exercise for,  
 556
- Urinary retention, from bed rest, 373
- Urinary solids, with massage, 321
- Urine, hysterical retention of, 512  
 sitz baths for, 45
- Urine chlorides, in artificial fever, 182
- Urticaria, bran baths for, 608  
 ultraviolet radiation contraindicated, 295
- Uterus, prolapse of, exercises for, 572-3
- Uveitis, exudative, fever therapy for, 197
- Uviol glass windows for heliotherapy, 281
- Vaginal irrigation, technique, 561-2
- Vaginismus, static wave for, 271, 572
- Valliant, N., 387
- Varicosities, thermal sensitivity affected  
 by, 433
- Vascular diseases, peripheral, *see* Peripheral  
 vascular diseases
- Vasoconstriction, caused by physical agents,  
 3  
 from conductive cold, 10-1, 29  
 of skin, by cold atmosphere, 68  
 of upper respiratory tract, 69  
 peripheral, 12
- Vasoconstrictors, cold, 3  
 effect on frostbite, 10  
 rest, 3
- Vasodilatation, caused by physical agents,  
 2-3  
 degree of, and heat exchange, 11-2  
 from continuous galvanic current, 224  
 of skin, in hot humid atmosphere, 68  
 peripheral, 11-2
- Vasodilators, carbon dioxide baths, 3  
 exercise, 3  
 heat, 3  
 mechanical stimulation, 3  
 ultraviolet radiation, 3
- Vasomotor rhinitis, zinc ions for, 238
- Vernal conjunctivitis, adrenalin, calcium,  
 radium for, 577  
 and photo-allergy, 295
- Vesiculitis acute, 553, 555

- Vibration, 326  
for fibrositis, 458-9
- Vichy douche, 64
- Virginia Hot Springs, 88-9
- Visceroptosis, after abdominal operations, 545  
faradic stimulation for, 545  
Morgan's regimen for, 545  
postpartum, electric exercises for, 545
- Visible radiation, heating effect of, 97-8  
reaction of body to, 98-9  
spectral limits of, 93
- Vision, loss of, in one eye, 421-2
- Visual impairment, in rehabilitation, 421-3  
treatment of, 421
- Vita glass windows for heliotherapy, 281
- Vitamin D, and activation of ergosterol, 290-2  
and cold quartz mercury vapor lamp, 285, 287  
clotting time of blood, 292  
from ergosterol, 290-2  
overdosage of, 292  
pharmacodynamic action of, 292  
produced in skin, 1  
sources of, 290, 292  
wave lengths causing, 290
- Vitamin deficiency, 292
- Vitamins in fever therapy, 183
- Viteles, vocational psychology tests, 412  
vocational rehabilitation tests, 413
- Vocational counselling, 408  
in blindness, 423
- Vocational guidance, in educational guidance, 427  
in reconditioning and rehabilitation, 427  
in tuberculosis 426
- Vocational rehabilitation, 408, 411  
mental health in, 412  
psychological tests for, 412-3  
resistance of education in, 412  
*See also* Rehabilitation
- Vocational testing, 408
- Volkman's ischemic contracture, 475
- Volt, 221
- Vomiting, during fever therapy, 192  
projectile sign of cerebral edema, 192
- Von Jauregg W, 174
- Von Ries J, 99
- Vrtak, mud for arthritis, 447
- Wakim, K. G., 534
- Walking, movements in, 359-60  
analysis of, 359-60  
posture for, 359-60
- Walking exercise, after poliomyelitis 500-1  
for cardiac cases, 521  
for tabes dorsalis, 510, 511  
for tubercular patients, 425, 599
- Walking machine, for assistive exercise, 340-1
- War injuries, among civilians, 443  
whirlpool baths for, 45
- Warts, destruction of, by electrosurgery, 205, 217, 608-9 by freezing, 26, 608-9  
magnesium ions for, 238
- Waser, E., 124-5, 487
- Water, as a cooling or heating medium, 29  
cooling power of, 14-5  
importance of, for applying heat and cold, 26  
intake of, reduced in nephritis 86  
loss of, from lungs, at high altitudes, 71, in artificial fever, 193  
sterilization of, by ultraviolet radiation, 299  
temperature of, 29-30  
the major constituent of the body, 29
- Waters, alkaline, medicinal uses, 82  
alum, 89  
earthy, medicinal uses, 83  
iron medicinal uses, 82-3  
saline, 79, 82-3  
saline alkaline, 83-85  
sulfated alkaline, 83, 85  
sulfur, medicinal uses of, 83
- Watson Jones on knee joint injuries, 467
- Wattless component, 164
- Wave length associated with temperature of emitting source, 91  
causing vitamin D, 290  
having bactericidal effects, 291, 297-300  
lethal to protozoa, 298  
of radiation, measurement of, 92  
of ultraviolet radiation, absorbed by eye media, 575 causing erythema, 293, solar, 275  
relation to heating, 165  
shortest, in sky shine, 275  
transmission of, 295
- Weather, 67 ff

- Weaving, in occupational therapy, 386  
 Webster, D. R., 534  
 Wehrmacher, on electrical stimulation in muscle atrophy, 267  
 Weiss, M., 77  
 Weisz, H., 150  
 Wet packs, contraindications for, 31  
     technique, 47-8  
 Wheelchairs, for paraplegics, 415  
 Whirlpool baths, *see* Baths, whirlpool  
 White Sulphur Springs, 89  
 Whooping cough, ultraviolet radiation for, 574  
 Williams on myalgia of head, 459  
 Wilson, P. D., 182, 477  
 Woodmansey, A., 446  
 Wood's glass, 289  
 Workshop, sheltered, in rehabilitation, 428-9  
 Wounds, healing of, by sun's rays, 280  
     infected, arm and hand baths for, 41  
     steam douches for, 65  
     ultraviolet radiation for, 275, 313  
 Wounds—(*Continued*)  
     whirlpool baths for cleansing, 43  
 Wrist joint, exercises for, 338-9  
 Wrists, craft exercises for, 382 ff., 400  
 Writer's cramp, massage for, 328  
 Xanthelasma, radium rays for, 576  
 Xanthelasma palpebrarum, 610  
 Xanthine, a photosensitizer, 296  
 Xanthoma, electrosurgery for, 216  
     freezing for, 610  
 Xeroderma pigmentosum, from ultraviolet radiation, 295  
 X-rays, 92-3, 592, 609-10, 612-4  
     and fever therapy in malignancies, 196-7  
 Yeo, Burney, 73  
 Young punch for prostatic obstruction, 557  
 Zander apparatus, for exercises, 339  
 Zinc ions, indications for, 238, 549, 579, 581-5, 593, 595

